

Your Operator's Manual



**Vehicle document wallet in the vehicle**

Here you can find information on operation, service work and the warranty for your vehicle in printed form.

eSprinter



Mercedes-Benz

eSprinter

Operator's Manual

Mercedes-Benz



9075840516

Order no. T907 0616 13 Part no. 907 584 05 16 Edition A-2025

## Front passenger air bag warning

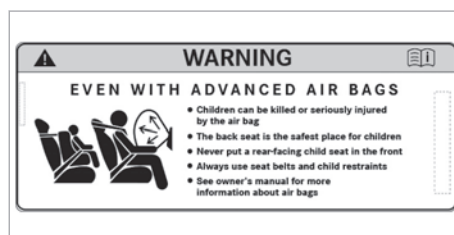

Air bag warning sticker for USA and Canada

### **⚠ WARNING** Risk of injury or fatal injuries if the front passenger air bag is enabled

If the front passenger air bag is enabled, a child on the front passenger seat may be struck by the front passenger air bag in the event of an accident.

- ▶ NEVER use a rearward-facing child restraint system on a seat with an ENABLED FRONT AIR BAG. This can result in the DEATH of or SERIOUS INJURY to the CHILD.

Observe the chapter entitled "Children in the vehicle".

## Publication details

### Website

Further information about Mercedes-Benz vehicles and about Mercedes-Benz AG can be found on the following websites:

<https://www.mercedes-benz.com>

<https://www.mbusa.com> (only USA)

<https://www.mercedes-benz.ca> (only Canada)

### Editorial team

© Daimler VANS USA, LLC

© Mercedes-Benz AG: Not to be reprinted, translated or otherwise reproduced, in whole or in part, without written permission from Mercedes-Benz AG.

### Vehicle manufacturer

Mercedes-Benz AG

Mercedesstraße 120

70372 Stuttgart

Germany

### Vehicle dealer

**Daimler VANS USA, LLC**

One Mercedes-Benz Drive

Sandy Springs, GA 30328

<https://www.mbusa.com> (only USA)

<https://www.mbvans.com>

Customer Assistance Center:

1-877-762-8267

**Mercedes-Benz Canada, Inc.**

2680 Matheson Blvd E, Suite 400

Mississauga, ON L4W 0A5

<https://www.mercedes-benz.ca> (only Canada)

Customer Assistance Center:

1-800-387-0100

Daimler VANS USA, LLC and Mercedes-Benz Canada, Inc. are Mercedes-Benz Group AG enterprises.

Canada only: "Authorised Sprinter Dealer" is defined as an authorised Mercedes-Benz Sprinter Dealer.

## Welcome to the world of Mercedes-Benz

Please read this Operator's Manual carefully and familiarize yourself with your vehicle before driving it for the first time. For your own safety and to extend the service life of the vehicle, follow the instructions and warnings in this Operator's Manual. Disregarding them may lead to damage to the vehicle or injury to people.

Damage to the vehicle caused by failure to observe the instructions is not covered by the Mercedes-Benz limited warranty.

The equipment features or product designations of your vehicle may differ from the content described in the Operator's Manual. The Operator's Manual describes the following content:

- The models and the standard and special equipment available at the time of this Operator's Manual going to press.
- The models and the standard and special equipment only available in certain countries.
- The models and the standard and special equipment which will only become available at a later date.

Please note that your vehicle may not be equipped with all features described. This also applies for systems and functions relevant to safety. Your vehicle may therefore differ, in individual cases, from that shown in the descriptions and illustrations.

Mercedes-Benz keeps advancing its vehicles constantly and reserves the right to introduce changes in the following areas:

- Design
- Equipment
- Technical features

Complete and up-to-date information about your vehicle and the description of any subsequently uploaded functions can be found in the Digital Operator's Manual in the multimedia system.

The original purchase agreement for your vehicle includes a list of the equipment features in your vehicle at the time of delivery.

The following documents are components of the vehicle:

- Printed Operator's Manual
- Maintenance Booklet (USA only)
- Equipment-dependent supplements
- Supplementary documents

Always keep these documents in the vehicle. Ensure that all documents are in the vehicle or passed on when the vehicle is sold or loaned out.

For questions concerning equipment and operation, please contact an authorized Mercedes-Benz Center.

The latest information on service and warranty, along with a digital copy of this Operator's Manual, can be found on the following website.

USA only:

<https://www.mbvans.com/en/vehicle-information>

Canada only:

<https://www.mercedes-benz-vans.ca/en/owners#manuals> (English)

<https://www.mercedes-benz-vans.ca/fr/owners#manuals> (French)

Daimler VANS USA, LLC

Mercedes-Benz Canada, Inc.

A Mercedes-Benz Group AG Company

### **Note on vehicles which are equipped by body manufacturers**

Always observe the Operator's Manual provided by the body manufacturer. You could otherwise fail to recognize potential dangers.

|  |           |   |            |
|--|-----------|---|------------|
| <b>Symbols</b> .....   | <b>4</b>  | Doors .....   | 41         |
| <b>At a glance</b> .....   | <b>6</b>  | Sliding door .....                                    | 45         |
| Cockpit .....  | 6         | Electric sliding door .....                           | 46         |
| Instrument cluster .....   | 7         | Rear-end doors .....                                  | 49         |
| Overhead control panel .....   | 8         | Partition sliding door .....                          | 51         |
| Door operating unit .....  | 10        | Side window .....                                     | 52         |
| Emergencies and breakdowns .....   | 12        | Anti-theft protection .....                           | 54         |
| <b>General notes</b> .....   | <b>13</b> | <b>Seats and stowage</b> .....                        | <b>57</b>  |
| Environmental protection .....   | 13        | Notes on the correct driver's seat position .....     | 57         |
| Mercedes-Benz GenuineParts .....   | 13        | Notes on grab handles .....                           | 57         |
| Attachments, add-on equipment, installations and conversions .....           | 14        | Seats .....   | 57         |
| Service and vehicle operation .....  | 15        | Steering wheel .....                                  | 66         |
| Operating safety .....   | 16        | Stowage areas .....                                   | 67         |
| Installing the license plate on the front license plate bracket .....        | 17        | Information about the bottle holder .....             | 68         |
| Declarations of conformity and notes on driving in different countries ..... | 18        | Cup holders .....                                     | 68         |
| Diagnostics connection .....   | 18        | Ashtray and cigarette lighter .....                   | 68         |
| Qualified specialist workshop .....  | 19        | Sockets .....   | 69         |
| Vehicle registration .....   | 19        | Installing and removing the floor mats .....          | 70         |
| Correct use of the vehicle .....   | 19        | <b>Light and vision</b> .....                         | <b>71</b>  |
| Multi-purpose vehicle .....  | 19        | Lighting .....  | 71         |
| Notes for persons with electronic medical aids .....                         | 20        | Adjusting the interior lighting .....                 | 74         |
| Problems with your vehicle .....   | 20        | Changing bulbs .....                                  | 76         |
| "Reporting safety defects" .....   | 21        | Windshield wipers .....                               | 80         |
| Limited Warranty .....   | 21        | Mirrors .....   | 82         |
| QR codes for rescue card .....   | 21        | <b>Climate control</b> .....                          | <b>85</b>  |
| Data storage .....   | 21        | Overview of climate control systems .....             | 85         |
| Copyright .....  | 24        | Operating climate control systems .....               | 87         |
| <b>Occupant safety</b> .....   | <b>26</b> | Operating air vents .....                             | 90         |
| Brief overview of most important points .....                                | 26        | Operating cargo compartment ventilation .....         | 91         |
| Information on the automatic functions of the restraint system .....         | 29        | Pre-entry climate control .....                       | 91         |
| Purpose and function of the restraint system .....                           | 29        | <b>Driving and parking</b> .....                      | <b>94</b>  |
| Seat belts .....   | 33        | Driving .....   | 94         |
| Airbags .....  | 33        | Drive programs .....                                  | 104        |
| <b>Children in the vehicle</b> .....   | <b>34</b> | Transmission .....                                    | 105        |
| Brief overview of most important points .....                                | 34        | Charging the high-voltage battery .....               | 107        |
| Important safety notes .....   | 34        | Parking .....   | 116        |
| Securing the child restraint system .....                                    | 36        | Driving and driving safety systems .....              | 119        |
| Child safety locks .....   | 37        | Trailer operation .....                               | 138        |
| <b>Opening and closing</b> .....   | <b>39</b> | <b>Instrument cluster and on-board computer</b> ..... | <b>144</b> |
| SmartKey .....   | 39        | Notes on the instrument cluster .....                 | 144        |
|  |           | Overview of the instrument cluster .....              | 144        |
|  |           | Function of the power availability display ..         | 145        |
|  |           | Operating the on-board computer .....                 | 145        |

Overview of instrument cluster display ..... 146  
 Function of the charge level display ..... 146  
 Display of the available power ..... 146  
 Overview of menus on the on-board computer ..... 147  
 Menus and submenus ..... 147  
 Adjusting the instrument lighting ..... 150

**Mercedes-Benz Connect calls and Digital Extras ..... 151**  
 Mercedes-Benz Connect calls ..... 151  
 Mercedes-Benz Connect ..... 153  
 MB Apps (Digital Extras) ..... 154

**Audio system ..... 155**  
 Notes on operating safety ..... 155  
 Overview and operation ..... 156  
 System settings ..... 157  
 Radio ..... 157  
 Media ..... 158  
 Telephone ..... 159

**Transporting ..... 162**  
 Notes on loading guidelines ..... 162  
 Notes on distributing the load within the vehicle ..... 162  
 Securing loads ..... 163  
 Carrier systems ..... 164  
 Placing a load on the wheel arch ..... 165

**Maintenance and care ..... 166**  
 ASSYST PLUS service interval display ..... 166  
 Calibrating the high-voltage battery ..... 166  
 Engine compartment ..... 169  
 Cleaning and care ..... 172

**Breakdown assistance ..... 177**  
 Emergency ..... 177  
 Emergency Call System ..... 177  
 Flat tire ..... 179  
 Battery ..... 179  
 Towing or tow-starting ..... 181  
 Electrical fuses ..... 184  
 Vehicle tool kit ..... 185  
 Hydraulic jack ..... 186

**Wheels and tires ..... 188**  
 Information on noise or unusual driving characteristics ..... 188

Notes on regularly inspecting wheels and tires ..... 188  
 Information on driving with summer tires ..... 188  
 Information on M+S tires ..... 189  
 Notes on snow chains ..... 189  
 Tire pressure ..... 190  
 Loading the vehicle ..... 195  
 Tire labeling ..... 197  
 Information on definitions (tires and loading) ..... 200  
 Changing a wheel ..... 202  
 Spare wheel ..... 208

**Technical data ..... 212**  
 Information on the technical data ..... 212  
 On-board electronics ..... 212  
 Radio regulations ..... 213  
 Vehicle identification plate, vehicle identification number (VIN) and engine number ..... 241  
 Operating fluids and capacities ..... 243  
 Vehicle data ..... 246  
 Trailer hitch ..... 247  
 Cargo tie-down points and carrier systems ..... 249

**Display messages and warning and indicator lamps ..... 251**  
 Display messages ..... 251  
 Indicator and warning lamps ..... 274

**Index ..... 282**

In these Operating Instructions, you will find the following symbols:

 **WARNING** Danger due to failure to observe the warning notices

Warning notices draw your attention to hazards that may endanger your health or life, or the health or life of others.

 Observe the warning notices.

 **ENVIRONMENTAL NOTE** Environmental damage due to failure to observe environmental notes

Environmental notes include information on environmentally responsible behavior or environmentally responsible disposal.

 Observe environmental notes.

 **NOTE** Damage to property due to failure to observe notes on material damage

Notes on material damage inform you of risks which may lead to your vehicle being damaged.

 Observe notes on material damage.

 These symbols indicate useful instructions or further information that could be helpful to you.

 Instructions

 Further information on a topic page)

**Display** Messages on the display

 Highest menu level to be selected in the multimedia/audio system

 Corresponding submenus to be selected in the multimedia/audio system

\* Indicates a cause

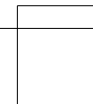
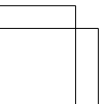
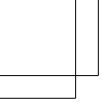

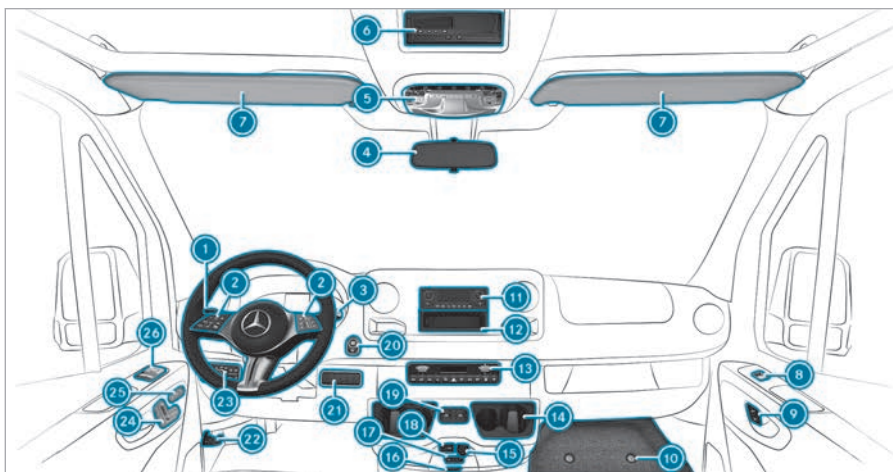

|                                 |   |   |   |     |
|---------------------------------|---|---|---|-----|
| ① Combination switch            |   | ⑭ Cup holder  | → | 67  |
| Turn signal indicators          | → | ⑮ 12 V socket                                       | → | 69  |
| High beam                       | → | ⑯ Key slot for KEYLESS-START                        | → | 98  |
| Windshield wipers               | → | ⑰ 115 V socket                                      | → | 69  |
| Rear window wiper               | → | ⑱ USB port  | → | 67  |
| ② Steering wheel Touch Control  | → | ⑲ Opens and closes the electric sliding door        | → | 46  |
| ③ DIRECT SELECT lever           | → | ⑳ Start/stop button                                 | → | 97  |
| ④ Inside mirror                 | → | ㉑ Right-hand switch panel                           |   |     |
| Digital inside mirror           | → | Activates/deactivates cargo compartment ventilation | → | 91  |
| ⑤ Overhead control panel        | → | ㉒ Opens the hood                                    | → | 169 |
| ⑥ Tachograph                    |   | ㉓ Light switch                                      | → | 71  |
| ⑦ Sun visor                     |   | Headlamp range adjuster                             | → | 72  |
| ⑧ Front passenger window lifter | → | ㉔ Adjusts the driver's seat                         | → | 60  |
| ⑨ Central locking system        | → | ㉕ Seat heating                                      | → | 66  |
| ⑩ Stowage compartment cover     | → | Central locking system                              | → | 42  |
| ⑪ Radio                         | → | ㉖ Driver's window lifter                            | → | 52  |
| ⑫ Device installation frame     |   |   |   |     |
| ⑬ Climate control system        | → |   |   |     |

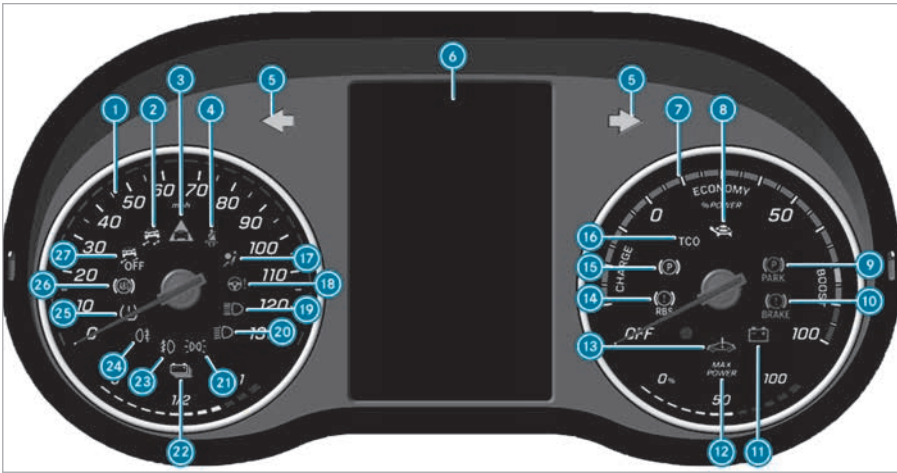

Instrument cluster (example)

**i** The functions of the existing indicator and warning lamps depend on the equipment.

|   |   |     |  |   |     |
|---|---|-----|--|---|-----|
| <b>1</b> Speedometer  | → | 144 | <b>14</b> <b>RBS</b> Regenerative brake system | → | 95  |
| <b>2</b> ESP®   | → | 276 | <b>15</b> Electric parking brake (yellow)      | → | 276 |
| <b>3</b> Distance warning   | → | 279 | <b>16</b> <b>TCO</b> Tachograph                | → | 279 |
| <b>4</b> Seat belt not fastened   | → | 275 | <b>17</b> Restraint system                     | → | 275 |
| <b>5</b> Turn signal light  | → | 72  | <b>18</b> Power steering malfunction           | → | 279 |
| <b>6</b> Instrument cluster display showing indicator and warning lamps |   |     | <b>19</b> High beam                            | → | 72  |
| Operational readiness of drive system                                   | → | 97  | <b>20</b> Low beam                             | → | 71  |
| Charge level display for high-voltage battery                           | → | 146 | <b>21</b> Side lights                          | → | 71  |
| <b>7</b> Power availability display                                     | → | 145 | <b>22</b> High-voltage battery reserve         | → | 280 |
| <b>8</b> Reduced power  | → | 280 | <b>23</b> Fog light                            | → | 71  |
| <b>9</b> Parking brake applied (red)                                    | → | 276 | <b>24</b> Rear fog light                       | → | 71  |
| <b>10</b> Brake malfunction   | → | 276 | <b>25</b> Tire pressure monitor                | → | 280 |
| <b>11</b> Electrical malfunction  | → | 260 | <b>26</b> ABS malfunction                      | → | 276 |
| <b>12</b> Maximum available output of the drive system                  | → | 146 | <b>27</b> ESP® deactivated                     | → | 276 |
| <b>13</b> System error  | → | 280 |  |   |     |

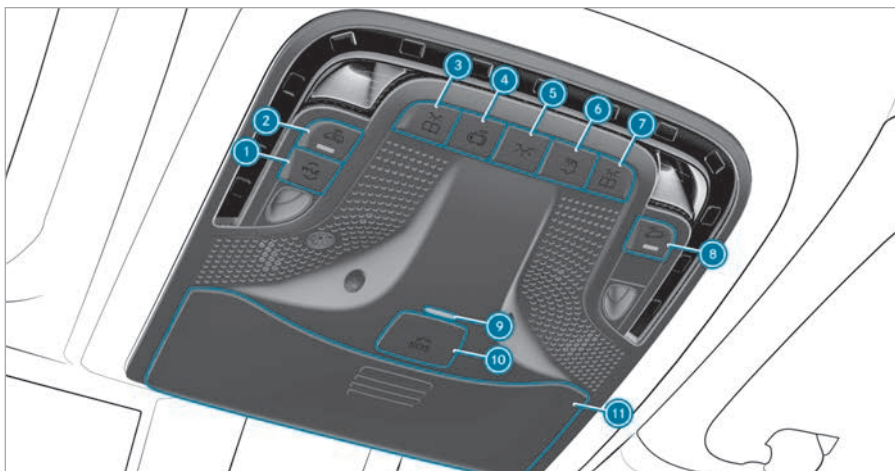

- i** Depending on the equipment, certain buttons may be unavailable or unassigned.
- |  |   |
|--|---|
| <b>1</b> Switches Mercedes-Benz Connect calls → 151                                  | <b>7</b> Switches the right-hand reading light on/off |
| <b>2</b> Switches interior protection on/off → 56                                    | <b>8</b> Switches tow-away alarm on/off → 55          |
| <b>3</b> Switches the left-hand reading light on/off                                 | <b>9</b> ATA indicator lamp → 54                      |
| <b>4</b> Switches automatic light control on/off                                     | <b>10</b> SOS emergency call button cover → 151       |
| <b>5</b> Switches the front interior lighting on/off                                 | <b>11</b> Glasses compartment                         |
| <b>6</b> Switches rear interior lighting on/off (unassigned, depending on equipment) |   |

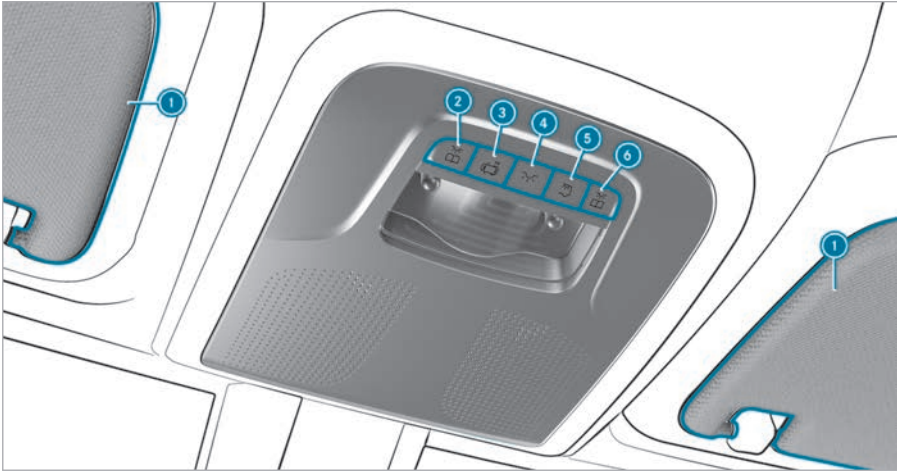



## Version 2 of the overhead control panel

**i** Depending on the equipment, certain buttons may be unavailable or unassigned.

**1** Sun visors

**2**  Switches the left-hand reading light on/off

**3**  Switches automatic light control on/off

**4**  Switches the front interior lighting on/off

**5**  Switches rear interior lighting on/off (unassigned, depending on equipment)

**6**  Switches the right-hand reading light on/off

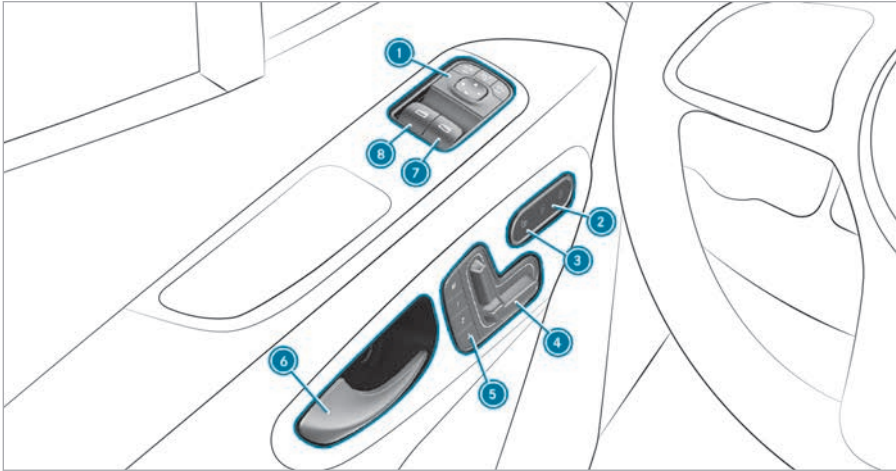



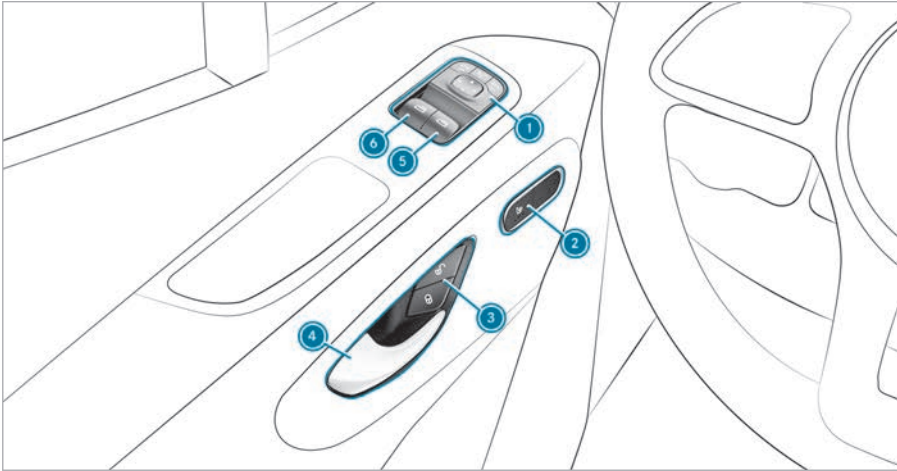

Door operating unit of vehicles with electrically adjustable seat

|   |  |
|---|--|
| ① Adjusts the outside mirrors → 82                | ⑤ <b>M</b> ① ② ③ Operates the memory function → 62 |
| ②   Unlocks/locks the central locking system → 43 | ⑥ Opens the door → 41                              |
| ③  Switches seat heating on/off → 66              | ⑦  Opens/closes the right-hand side window → 52    |
| ④ Adjusts the front seats electronically → 60     | ⑧  Opens/closes the left-hand side window → 52     |



Door operating unit of vehicles without electrically adjustable seat

|   |  |
|---|--|
| ① Adjusts the outside mirrors → 82  | ④ Opens the door → 41  |
| ②  Switches seat heating on/off → 66   | ⑤  Opens/closes the right-hand side window → 52 |
| ③   Unlocks/locks the central locking system → 43 | ⑥  Opens/closes the left-hand side window → 52  |

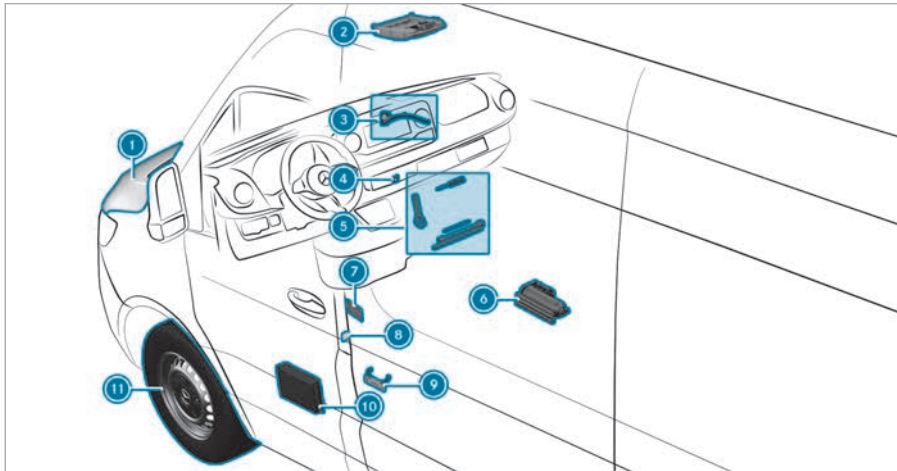

|   |  |
|---|--|
| ① Check and add operating fluids → 243                                      | ⑧ QR code for accessing the rescue card below the lock strikers of the door on both the driver's and front passenger side → 21 |
| ② Buttons for the SOS emergency call system and Mercedes-Benz connect → 178 | ⑨ High-voltage disconnect device in the seat base → 94   |
| ③ High-voltage disconnect device at front in the engine compartment → 94    | ⑩ First-aid kit  |
| ④ Hazard warning lights → 73  | First-aid kit → 177  |
| ⑤ Vehicle tool kit → 185  | ⑪ Flat tire → 179  |
| ⑥ Jack → 187  | Further emergency and breakdown devices:   |
| ⑦ Information label for tire pressure → 190                                 | Spare wheel → 208  |

## Environmental protection

 **ENVIRONMENTAL NOTE** Environmental damage due to operating conditions and personal driving style

Operate your vehicle in an environmentally responsible manner to help protect the environment. Please observe the following recommendations on operating conditions and personal driving style.

### Operating conditions:

- ▶ Make sure that the tire pressures are correct.
- ▶ Do not carry any unnecessary weight (e.g. roof luggage racks once you no longer need them).
- ▶ Monitor energy consumption.
- ▶ Adhere to the service intervals.  
A regularly serviced vehicle will contribute to environmental protection.
- ▶ Always have maintenance work carried out at a qualified specialist workshop.

### Personal driving style:

- ▶ Drive carefully and maintain a suitable distance from the vehicle in front.
- ▶ Avoid frequent, sudden acceleration and braking.
- ▶ Drive in a way that conserves energy.  
Pay attention to the ECO display for an economical driving style.

 **ENVIRONMENTAL NOTE** Environmental pollution caused by irresponsible disposal of the high-voltage battery

A high-voltage battery contains materials which are harmful to the environment.

- ▶ Dispose of defective high-voltage batteries at a qualified specialist workshop.

### Environmental issues and recommendations

It is recommended that you re-use or recycle materials instead of simply disposing of them.

The relevant environmental guidelines and regulations serve to protect the environment and should be followed carefully.

## Mercedes-Benz GenuineParts

 **ENVIRONMENTAL NOTE** Environmental damage due to not using recycled reconditioned components

Mercedes-Benz AG offers recycled reconditioned components and parts with the same quality as new parts. The same entitlement from the Limited Warranty is valid as for new parts.

- ▶ Use recycled reconditioned components and parts from Mercedes-Benz AG.

 **NOTE** Impairment of the operating efficiency of the restraint systems from installing accessory parts or from repairs or welding

Air bags and Emergency Tensioning Devices, as well as control units and sensors for the restraint systems, may be installed in the following areas of your vehicle:

- doors
- door pillars
- sill
- seats
- cockpit
- instrument display
- center console
- lateral roof frame

- ▶ Do not install accessory parts such as audio systems in these areas.
- ▶ Do not carry out repairs or welding.
- ▶ Have accessories retrofitted at a qualified specialist workshop.

If you use parts, tires, wheels or safety-relevant accessories that have not been approved by Mercedes-Benz, the operating safety of the vehicle may be jeopardised. Safety-critical systems such as the brake system may malfunction. Use only Mercedes-Benz GenuineParts or parts of equal quality. Use only tires, wheels and accessory parts that are approved for your vehicle model.

Mercedes-Benz GenuineParts are subject to strict quality inspections. Every part has been specially developed, manufactured or selected for Mercedes-Benz vehicles and adapted to them. For this reason, only Mercedes-Benz GenuineParts should be used.

More than 300,000 Mercedes-Benz GenuineParts are available for all Mercedes-Benz models.

All authorized Mercedes-Benz Center maintain a stock of Mercedes-Benz GenuineParts for all service and repair work required. Parts delivery center are also strategically distributed to ensure a fast and reliable parts service.

Always specify the vehicle identification number (VIN) when ordering Mercedes-Benz GenuineParts (→ page 241).

### Attachments, add-on equipment, installations and conversions

#### Notes on body/equipment mounting directives

For safety reasons, have add-on equipment produced and installed in accordance with the valid Mercedes-Benz body/equipment mounting directives. These body/equipment mounting directives ensure that the chassis and add-on equipment form one unit and that the greatest possible level of operational and driving safety is achieved.

Both vehicle manufacturers and body manufacturers must always ensure that the products they manufacture come into circulation only in a safe state and do not pose any risks to people. Otherwise, there may be consequences under civil, criminal or public law. All manufacturers are responsible for the products that they have manufactured. Manufacturers of attachments, add-on equipment, installations and conversions must guarantee compliance with Directive 2001/95/EC on general product safety.

The body manufacturer must also ensure compliance with standards concerning operational reliability (in accordance with ISO 26262) and cyber security (in accordance with ISO 21434 and UN R155).

Mercedes-Benz recommends the following procedure for safety reasons:

- Do not make any other changes to the vehicle.
- Obtain approval from the dealer named on the inside title page in the event of deviations from the approved body/equipment mounting directives.

Acceptance tests performed by public test bodies or official approvals do not rule out safety risks.

Observe the information about Mercedes-Benz Genuine Parts (→ page 13).

- ① You can obtain further information at a qualified specialist workshop.

- ① You can find further information on requesting a check for compatibility with the basic vehicle in the body/equipment mounting directives.
- ① Structural changes to high-voltage components, high-voltage lines and equipotential bonding lines are not permitted.
- ① If work is carried out on a vehicle with an electric drive, the country-specific requirements concerning statutory occupational safety and accident prevention regulations must be observed.

**⚠ WARNING** Risk of accident and injury in the event of improper conversions or changes to the vehicle

Conversions or changes to the vehicle can prevent systems or components from functioning properly and/or jeopardize the vehicle's operational safety.

▶ Always have conversions or changes to the vehicle carried out at a qualified workshop.

If you intend to make changes to your vehicle, Mercedes-Benz strongly recommends that you contact the dealer. They will give you all the information you need. There may be a charge for this service.

If body manufacturers and dealers make modifications that affect the final inspection of the engine, vehicle or equipment, they must accept sole responsibility for the vehicle. This also applies to marking and documenting the vehicle parts affected by the changes that they make.

You are responsible for ensuring and providing evidence that the following conditions are met:

- The vehicle complies with all relevant standards and regulations that are affected by the modification.
- The modified vehicle still meets vehicle safety standards and emissions laws and regulations.
- The modification does not impair the safety of the vehicle.

Mercedes-Benz is not responsible for the final inspection, product liability or warranty claims resulting from modification. This applies to the following points:

- The modified components or systems
- The resultant violation of emissions laws and regulations or vehicle safety standards
- All consequences resulting from the modified, less safe or even faulty vehicle

Mercedes-Benz accepts no responsibility as final manufacturer or for the resultant product liability.

#### Notes on the cargo floor

The factory equips the vehicle with a wooden or plastic cargo floor; this is an integral part of the vehicle structure. If you have the cargo floor removed, the vehicle body may be damaged. Load securing will then be impaired and the maximum loading capacity of the tie-down points will no longer be guaranteed. Therefore, do not have the cargo floor removed.

#### Notes on the partition

Without a partition, vehicles that are approved as commercial vehicles (N1, N2) do not fulfill ISO 27956, which describes the equipment for properly securing a load in delivery vehicles. If the vehicle is used to transport goods, retrofitting the partition is strongly recommended, as properly securing the load in vehicles without a partition will always be complex.

### Service and vehicle operation

#### Warranty

The limited warranty for your vehicle is in accordance with the warranty terms and conditions in the Service and Warranty Information booklet.

Your Mercedes-Benz will replace and repair all factory-installed parts in accordance with the terms of the following warranty terms and conditions:

- New Vehicle Limited Warranty
- State Warranty Enforcement Laws ("Lemon Laws")

Replacement parts and accessories are covered by the Mercedes-Benz Parts and Accessories Warranties.

These are available at any Mercedes-Benz.

- ❗ Should you lose your Service and Warranty Information booklet, have an Mercedes-Benz arrange for a replacement. The new Service

and Warranty Information booklet will be posted to you.

#### Vehicle operation outside the USA or Canada

If you drive your vehicle abroad, service facilities or replacement parts may not be immediately available.

Certain Mercedes-Benz models are available in Europe through the European Delivery Program. Please consult a Mercedes-Benz service center for further information or write to one of the following addresses:

##### In the USA:

Daimler VANS USA, LLC  
One Mercedes-Benz Drive  
Sandy Springs, GA 30328

##### In Canada:

Mercedes-Benz Canada, Inc.  
2680 Matheson Blvd E, Suite 400  
Mississauga, ON L4W 0A5

#### Maintenance

USA only:

Your customer service advisor will record every service for you in the Service and Warranty Information booklet.

#### Roadside Assistance

Roadside Assistance offers technical help in the event of a breakdown. Your calls to the toll-free Roadside Assistance Hotline are answered by our agents 24 hours a day, 365 days a year.

1-877-762-8267 (USA)

1-800-387-0100 (Canada)

USA only: You can find further information in the Mercedes-Benz Roadside Assistance Program brochure.

Canada only: You can find further information in the "Roadside Assistance" section in the Warranty Information Guide. Please refer to Mercedes-Benz Canada's website:

<https://www.mercedes-benz-vans.ca/en/owners#manuals> (English)

<https://www.mercedes-benz-vans.ca/fr/owners#manuals> (French)

### Change of address or change of ownership

In the event of a change of address, please send us the "Notification of Address Change" in the Service and Warranty Information booklet, or simply call the Customer Assistance Center (USA) on the hotline number 1-877-762-8267 or Customer Service (Canada) on 1-800-387-0100. This will give us the opportunity to get in touch with you as soon as possible when necessary.

If you sell your Mercedes, please leave the entire literature in the vehicle so that it is available to the next owner. If you have purchased a used vehicle, please send us the "Notice of Purchase of Used Car" in the Service and Warranty Information booklet or call the Customer Assistance Center (USA) on the hotline number 1-877-762-8267 or Customer Service (Canada) on 1-800-387-0100.

### Possible danger due to substances hazardous to health

In compliance with Proposition 65 ("Prop65"), the following detachable label has been added to each vehicle sold in California:



### **Operating safety**

**⚠ WARNING** Risk of accident due to malfunctions or system failures

If you do not have the prescribed service/maintenance work or any required repairs carried out, this could result in malfunctions or system failures.

- ▶ Always have the prescribed service and maintenance work or any required repairs carried out in a qualified specialist workshop.

**⚠ WARNING** Risk of accident or injury due to incorrect modifications on electronic component parts

Modification of electronic components, their software or wiring could impair their function and/or the function of other networked component parts or safety-relevant systems.

This can endanger the operating safety of the vehicle.

- ▶ Never tamper with the wiring and electronic component parts or their software.
- ▶ You should have all work on electrical and electronic components carried out at a qualified specialist workshop.

Please observe the "Vehicle electronics" section in the "Technical data".

**! NOTE** Damage to the vehicle caused by driving too fast and by blows to the underbody and chassis parts

The vehicle can be damaged in the following cases in particular:

- The underside of the vehicle makes contact with the ground, e.g. on a high curb or an unpaved road.
- The vehicle drives too quickly over an obstacle, e.g. a curb, a speed bump or a pothole.
- A heavy object hits the underbody or chassis components.

In these or similar situations, the vehicle body, the underbody, chassis components, wheels or tires and parts of the high-voltage battery could be damaged even if this is not visible. Components that have been damaged in this way can fail unexpectedly or, in the event of an accident, may not absorb the loads that arise as intended.

- ▶ Have the vehicle checked and repaired immediately at a qualified specialist workshop.

or

- ▶ If driving safety is impaired during the rest of the journey, stop immediately paying attention to the traffic situation and notify a qualified specialist workshop.

An electric vehicle has an electric motor. The electric motor's power supply is provided by the high-voltage on-board electrical system.

**⚠ DANGER** Risk of death and fire due to modified and/or damaged components of the high-voltage on-board electrical system

The vehicle's high-voltage on-board electrical system is under high voltage. If you modify component parts in the vehicle's high-voltage on-board electrical system or touch damaged component parts, you may be electrocuted. In addition, modified and/or damaged components may cause a fire.

In the event of an accident or impact to the underbody, components of the high-voltage electrical system may be damaged although the damage is not visible.

- ▶ Never make any modifications to the high-voltage on-board electrical system.
- ▶ Do not switch on or use the vehicle if its high-voltage on-board electrical system components have been modified or damaged.
- ▶ Never touch damaged components of the high-voltage on-board electrical system.
- ▶ After an accident, do not touch any components of the high-voltage on-board electrical system.
- ▶ After an accident, have the vehicle transported away.
- ▶ Have the components of the high-voltage on-board electrical system checked at a qualified specialist workshop and replaced if necessary.

The components of the vehicle's high-voltage on-board electrical system are marked with yellow warning stickers. The cables of the vehicle's high-voltage on-board electrical system are orange.

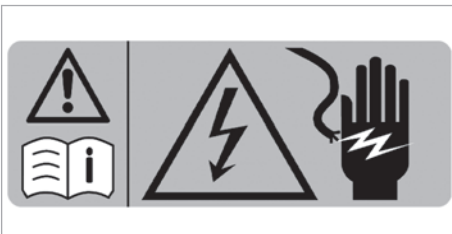

Example

High-voltage components that may become very hot are marked with separate warning labels:



Example

Vehicles with an electric motor generate significantly less noise than vehicles with internal combustion engines. As a result, your vehicle may not be heard by other road users in certain situations. This can occur, for example, when you are parking and your vehicle cannot be seen by other road users. In order to allow for the possibility that other road users may behave incorrectly, adopt a particularly anticipatory driving style.

The vehicle is additionally equipped with a sound generator, which serves as an Acoustic Vehicle Alerting System (AVAS) (→ page 94). This safety system is prescribed by law.

The outside sound produced by the sound generator (AVAS) can be heard in the passenger compartment at low speeds and it is not a malfunction.

**Installing the license plate on the front license plate bracket**

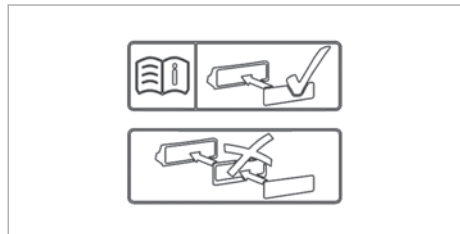

**!** **NOTE** Malfunctions and system failures due to incorrect installation of the license plate on the front license plate holder

If the license plate is incorrectly installed on the front license plate holder, sensors, cameras or driving and safety systems may malfunction or fail.

Observe the following points when installing the license plate on the front license plate holder:

- ▶ Install the license plate directly on the license plate holder without advertising media or other holders.
- ▶ Install the license plate so that it does not protrude from the bottom or side of the license plate adapter.

### Declarations of conformity and notes on driving in different countries

#### Country-specific information for regulatory radio components

##### Notes on modifications to radio components

Modifications to radio components may result in the operating permit for the relevant radio components being invalidated. The manufacturer of a radio component will not be held responsible for any such modifications.

##### Notes when crossing national borders

You must observe the regulatory provisions concerning radio for the country in which you are currently driving when operating the vehicle.



USA: "The wireless devices of this vehicle comply with Part 15 of the FCC Rules. Operation is subject to the following two conditions: 1) These devices may not cause harmful interference, and 2) These devices must accept any interference received, including interference that may cause undesired operation. Changes or modifications not expressly approved by the party responsible for compliance could void the user's authority to operate the equipment."

Canada: "The wireless devices of this vehicle comply with Industry Canada licence-exempt RSS standard(s). Operation is subject to the following two conditions: (1) These devices may not cause interference, and (2) These devices must accept any interference, including interference that may cause undesired operation of the device".

USA: "Wireless charging system for mobile devices (Model: WM13.5 Wireless Mobile Interface): This Device complies with Part 18 of the FCC Rules."

The name and address of the responsible party is: Molex CVS

Mizarstraße 3  
12529 Schönefeld  
Germany

### Diagnostics connection

The diagnostics connection is a technical interface in the vehicle. It is used, for example, during repair and maintenance work or for issuing readouts of vehicle data in a specialist workshop. Diagnostic devices should therefore be connected only in a qualified specialist workshop.

**⚠ WARNING** Risk of accident due to connecting devices to the diagnostics connection

If you connect devices to the diagnostics connection of the vehicle, the function of vehicle systems and operating safety may be impaired.

- ▶ For safety reasons, we recommend that you use and connect only products approved by an authorized Mercedes-Benz Service Center.

**⚠ WARNING** Risk of accident due to objects in the driver's footwell

Objects in the driver's footwell may impede pedal travel or block a depressed pedal.

This will jeopardize the operating- and road safety of the vehicle.

- ▶ Stow all objects in the vehicle securely so that they cannot get into the driver's footwell.
- ▶ Make sure that there is always sufficient clearance for the pedals.
- ▶ Always install the floor mats securely and as prescribed.
- ▶ Do not use loose floor mats and do not place floor mats on top of one another.

**! NOTE** Battery discharging from using devices connected to the diagnostics connection

Using devices at the diagnostics connection drains the battery.

- ▶ Check the charge level of the battery.
- ▶ If the charge level is low, charge the battery.

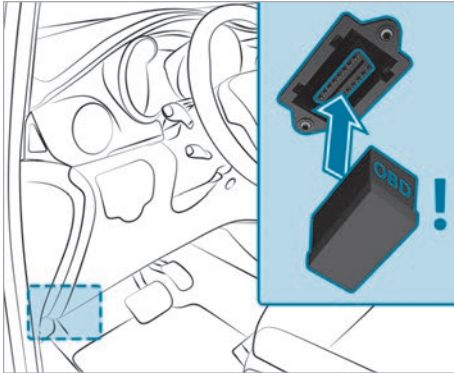

The connection and use of another device on the diagnostics connection can have the following effects:

- Malfunctions in the vehicle system
- Permanent damage to vehicle components

Please refer to the warranty terms and conditions regarding this.

#### Qualified specialist workshop

A qualified specialist workshop has the necessary special skills, tools and qualifications to correctly carry out any necessary work on your vehicle. This particularly applies to work relevant to safety.

Always have the following work on the vehicle carried out at a qualified specialist workshop:

- Safety-relevant works
- Service and maintenance work
- Repair work
- Modifications as well as installations and conversions
- Work on electronic components
- Work on high-voltage components

Mercedes-Benz recommends that you use an authorized Mercedes-Benz for this purpose.

#### Vehicle registration

Mercedes-Benz may ask its service centers to carry out technical inspections on certain vehicles. The quality or safety of the vehicles is improved as a result of the inspection.

Mercedes-Benz can only inform you about vehicle checks if Mercedes-Benz has your registration data.

In the following cases, your vehicle may not be registered to you yet:

- you did not purchase your vehicle at an authorized specialist dealer.
- your vehicle has not yet been inspected at a Mercedes-Benz Service Center.

It is advisable to register your vehicle with a Mercedes-Benz Service Center.

Inform Mercedes-Benz as soon as possible about any change in address or vehicle ownership.

You can do this at a Mercedes-Benz Service Center, for example.

#### Correct use of the vehicle

If you remove warning stickers, you or others may fail to recognize the dangers. Leave warning stickers in position.

Observe the following information in particular when operating the vehicle:

- Safety notes in these operating instructions
- Technical data for the vehicle
- Traffic rules and regulations of the country in which you are currently located
- Laws pertaining to motor vehicles and safety standards of the country in which you are currently located
- Radio regulations of the country in which you are currently located

#### Multi-purpose vehicle

**▲ WARNING** Risk of accident when the center of gravity is too high

The vehicle may start to skid and rollover in the event of sudden steering maneuvers and/or when the vehicle's speed is not adapted to the road conditions.

- ▶ Always adapt your speed and driving style to the vehicle's driving characteristics and to the prevailing road and weather conditions.

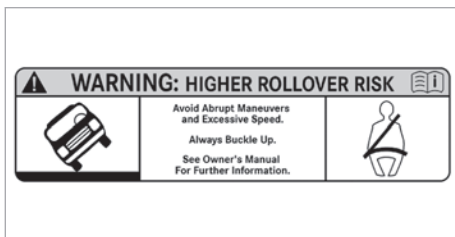

## USA

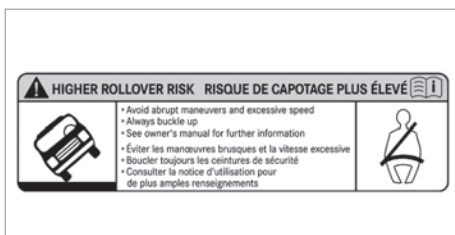

## Canada

Utility vehicles have a significantly higher rollover rate than other types of vehicles.

Unsafe operation of the vehicle can result in an accident or rollover, as well as serious or even fatal injuries.

In a rollover crash, an unbelted person is significantly more likely to die than a person wearing a seat belt.

You and all vehicle occupants should always wear seat belts.

### Notes for persons with electronic medical aids

Despite meticulous development of their vehicle systems, -Mercedes-Benz AG cannot completely rule out the interaction of vehicle systems with electronic medical aids, such as cardiac pacemakers.

In addition, there are components built into the vehicle that, regardless of the operating status of your vehicle, can generate magnetic fields on a par with permanent magnets. These fields can be found, for example, in the area around the multimedia and sound system or also in the seating area, depending on the vehicle equipment.

It is therefore possible for the following to occur in isolated cases, depending on the aids used:

- medical aids malfunctioning
- adverse health effects

Observe the notes and warnings of the manufacturer of the medical aids; if in doubt, contact the device manufacturer and/or your doctor. If there is continuing uncertainty concerning the possibility of medical aids malfunctioning, -Mercedes-Benz AG recommends using only few electrical vehicle systems and/or maintaining a distance from the components.

When charging the high-voltage battery, keep a distance of at least an arm's length between the medical aid and the following components:

- the power supply equipment  
This includes charging stations in the form of a wallbox or a public charging point, for example.
- vehicle components carrying live voltage  
This includes the charging cable and the charging control box, for example.

Have repairs and maintenance work in close proximity to the following components carried out only by a qualified specialist workshop:

- vehicle components carrying live voltage
- transmission aerials
- multimedia system and sound system

If you have any queries or suggestions, consult a qualified specialist workshop.

### Problems with your vehicle

If you experience a problem with your vehicle, particularly one that you believe may affect vehicle safety, we urge you to contact an Mercedes-Benz immediately to have the problem diagnosed and rectified.

If the problem is not resolved to your satisfaction there, please contact an Mercedes-Benz again or write to one of the following addresses.

#### In the USA:

Daimler VANS USA, LLC  
Customer Assistance Center  
One Mercedes-Benz Drive  
Sandy Springs, GA 30328

#### In Canada:

Mercedes-Benz Canada, Inc.  
Customer Assistance Center  
2680 Matheson Blvd E, Suite 400  
Mississauga, Ontario L4W 0A5

## "Reporting safety defects"

### USA only:

The following text is published as required of manufacturers under Title 49, Code of U.S. Federal Regulations, Part 575 pursuant to the "National Traffic and Motor Vehicle Safety Act of 1966".

If you believe that your vehicle has a defect which could cause a crash or could cause injury or death, you should immediately inform the National Highway Traffic Safety Administration (NHTSA) in addition to notifying Daimler VANS USA, LLC.

If NHTSA receives similar complaints, it may open an investigation, and if it finds that a safety defect exists in a group of vehicles, it may order a recall and remedy campaign. However, NHTSA cannot become involved in individual problems between you, your dealer, or Daimler VANS USA, LLC.

To contact NHTSA, you may call the Vehicle Safety Hotline toll-free at 1-888-327-4236 (TTY: 1-800-424-9153); go to <https://www.safercar.gov>; or write to: Administrator, NHTSA, 400 Seventh Street, SW., Washington, DC 20590, USA.

For further information on vehicle safety, go to: <https://www.safercar.gov>

### Canada only:

The following text is published as required of manufacturers under subsection 18.4 (4) of the Motor Vehicle Safety Regulations.

If you believe that your vehicle has a defect which could cause a crash or could cause injury or death, you should immediately inform Transport Canada in addition to notifying Mercedes-Benz Canada Inc.

If Transport Canada received similar complaints, it may open an investigation, and if it finds that a safety defect exists in a group of vehicles, it may order a recall and remedy campaign. However, Transport Canada cannot become involved in individual problems between you, your dealer, or Mercedes-Benz Canada Inc.

To contact Transport Canada, you may call the Defect Investigations and Recalls Division toll-free in Canada at 1-800-333-0510 or 819-994-3328 in the Gatineau-Ottawa area or internationally; may also go to the following websites for more information:

- English: [www.tc.gc.ca/recalls](http://www.tc.gc.ca/recalls)
- French: [www.tc.gc.ca/rappels](http://www.tc.gc.ca/rappels)

## Limited Warranty

**NOTE** Damage to the vehicle arising from violation of these operating instructions.

Damage to the vehicle can arise from violation of these operating instructions.

Such damage is not covered by either the Limited Warranty or the new or used-vehicle warranty.

- ▶ Observe the instructions in these operating instructions on proper operation of your vehicle as well as regarding possible vehicle damage.

## QR codes for rescue card

The QR code stickers are affixed to the B-pillars on the driver's and front passenger sides. In the event of an accident, emergency services can use the QR code to quickly determine the corresponding rescue card for your vehicle. The current rescue card contains the most important information about your vehicle (e.g. the routing of the electric lines) in compact form.

You can find further information at: <https://rk.mb-qr.com/de/>

## Data storage

### Data processing in the vehicle

#### Electronic control units

Electronic control units are installed in your vehicle. Control units process data they receive from vehicle sensors, for example, generate themselves or exchange between themselves. Some control units are required for the safe operation of your vehicle. For example, some assist you when driving, such as driver assistance systems, while others enable functions serving comfort or infotainment.

The following provides you with general information regarding data processing in the vehicle. Additional information regarding which data in your vehicle is collected, saved and transmitted to third parties and for what purpose can be found in the information directly related to the functional characteristics in question in the respective Operator's Manual. This information is available both online and digitally, depending on the vehicle's equipment.

**Personal data**

A unique vehicle identification number identifies every vehicle. Depending on the country, this vehicle identification number can be used by, for example, governmental authorities to determine the owner's identity. There are other possibilities for using data collected from the vehicle to identify the owner or driver, such as the license plate number.

Therefore, data generated or processed by control units may be attributable to a person or, under certain conditions, become attributable to a person. Depending on which vehicle data are available, it may be possible to make inferences about, for example, your driving behaviour, location, route or use patterns.

**Legal requirements regarding the disclosure of data**

If legally required to do so, manufacturers are legally obliged on a case-by-case basis to provide data stored by the manufacturer to governmental entities, upon request and to the extent required. For example, this may come into effect during the investigation of a criminal offense.

Governmental entities are themselves authorised to read out data from the vehicle in individual cases and within the applicable legal framework. Following an accident, information that can help with an investigation can be taken from the air bag control unit, for example.

**Operational data in the vehicle**

Data processed by control units for operation of the vehicle.

This includes the following data, for example:

- Vehicle status information such as the speed, longitudinal acceleration, lateral acceleration, number of wheel revolutions or the fastened seat belts display
- Ambient conditions, such as temperature, rain sensor or distance sensor

Generally, these are short-term data and will not be stored beyond the period of operation, and is processed only within the vehicle itself. Control units, for example vehicle keys, often contain data memories. Their use permits the temporary or permanent documentation of technical information regarding the vehicle's operating state, component loads, maintenance requirements and technical events or malfunctions.

Depending on the technical equipment, the following data are stored:

- Operating status of system components, such as fill levels, tire pressure or battery status
- Malfunctions or defects in important system components, such as lights or brakes
- System reactions in special driving situations, such as air bag deployment or the intervention of stability control systems
- Information on events leading to vehicle damage
- State of charge for the high-voltage battery, estimated range

In certain cases, storing data that would have otherwise been temporary may be required. This may be the case if the vehicle has detected a malfunction, for example.

If you use services such as repair services and maintenance work, stored operational data and the vehicle identification number can be read out and used as required. They can be read out from the vehicle by service network employees, such as those working for workshops, manufacturers or third parties (e.g. breakdown services). The same applies for warranty claims and quality assurance measures.

In general, the readout is performed via the legally prescribed port for the diagnostics connection in the vehicle. The operating data read out documents the vehicle's or individual components' technical condition and help to diagnose faults, ensure compliance with warranty obligations and bring about improvements in quality. To that end, this data, and in particular information pertaining to component loads, technical events, malfunctions and other faults may be transmitted along with the vehicle identification number to the manufacturer. Furthermore, the manufacturer is subject to product liability. For this reason, the manufacturer also uses operational data from the vehicle, for example, for recalls. These data can also be used to examine the customer's warranty and legal guarantee claims.

Fault memories in the vehicle can be reset by a service outlet or at your request as part of repair or maintenance work.

**Functions serving comfort and infotainment**

You can store the vehicle's settings for comfort and customisations, and can change or reset them at any time.

Depending on the vehicle equipment, this includes the following settings, for example:

- Seat and steering wheel positions
- Suspension tuning and climate control settings
- Customisation settings, such as interior lighting

Depending on the selected equipment, you can import data into vehicle infotainment functions yourself.

Depending on the vehicle equipment, this includes the following data, for example:

- Multimedia data, such as music, films or photos for playback in an integrated multimedia system
- address book data for use in connection with an integrated hands-free system or an integrated navigation system
- entered navigation destinations
- data for the use of Internet services

These data for functions serving comfort and infotainment may be saved locally in the vehicle or on a device connected to the vehicle, such as a smartphone, USB flash drive or MP3 player. Data that you have entered yourself can be deleted at any time.

These data are transmitted only from the vehicle to third parties at your request. This applies in particular when using online services from your own selected settings.

### Smartphone integration (e.g. Android Auto or Apple CarPlay®)

If your vehicle is equipped accordingly, you can connect your smartphone or another mobile end device to the vehicle. You can then control them through the control elements integrated into the vehicle. Images and audio from the smartphone can be relayed through the multimedia system. Certain information is simultaneously transferred to your smartphone. Depending on the type of integration, this includes position data, day/night mode and other general vehicle statuses. For more information, please consult the Operator's Manual for the vehicle or in the infotainment system.

This integration allows the use of selected smartphone apps, such as navigation or music player apps. There is no further interaction between the smartphone and the vehicle; in particular effective access to vehicle data. The type of additional data processing is determined by the provider of the app being used. Permissible settings, if any, will

depend on the specific app and your smartphone's operating system.

## Online services

### Wireless network connection

If your vehicle has a wireless network connection, data can be exchanged between your vehicle and other systems. The wireless network connection is made possible by the vehicle's own transmitter and receiver or by a mobile end device that you have brought into the vehicle, for example, a smartphone. Online functions can be used via this wireless network connection. This includes online services and applications/apps provided to you by the manufacturer or by other providers.

### Manufacturer's own services

Regarding the manufacturer's online services, the individual functions are described by the manufacturer in a suitable place, for example, in the Operator's Manual or on the manufacturer's website, where the relevant data protection information is also given. Personal identification data may be used to provide online services. Data is exchanged via a secure connection, e.g. the manufacturer's designated IT systems. Any personal data which are collected, processed and used, other than for the provision of services, is done so exclusively on the basis of legal permission. This is the case, for example, for a legally prescribed emergency call system, a contractual agreement or when consent has been given.

You can have services and functions, some of which are subject to a fee, activated or deactivated. This excludes legally prescribed functions and services, such as an emergency call system.

### Services of third parties

If you use online services from other providers (third parties), these services are the responsibility of the provider in question and subject to that provider's data protection conditions and terms of use. As a general rule, the manufacturer has no influence on the content exchanged.

For this reason, when services are provided by third parties, please ask the service provider in question for information about the type, extent and purpose of the collection and use of personal data.

### Onboard Logic Unit (OLU)

The Onboard Logic Unit (OLU) is available to commercial customers.

It contains control units, including antennas for connection via wireless networks, that permit the

exchange of data between your vehicle and other systems. The control units can be used in conjunction with service provided by a third party. Under certain circumstances, these services may alter the basic configuration of the vehicle and could affect the performance of certain vehicle functions.

For further information about specific services, read the Operator's Manual of the third-party provider. For further information about the Onboard Logic Unit, consult an authorized Mercedes-Benz Center.

If you, yourself, do not own and are not responsible for the vehicle, you may not know the current status of the Onboard Logic Unit. For further information concerning the services which are currently active, including any data which may be being processed as defined by the GDPR, please contact the person responsible for the vehicle.

### Data protection rights

Depending on the country, the equipment and functions of your vehicle, and the services and service offerings used, you are entitled to different data protection rights. Further information on data protection and your data protection rights can either be found on the manufacturer's website or you will receive this information as part of the various services and service offers. There, you will also find the contact information for the manufacturer and its data protection officer.

At a workshop, for example, with the support of a specialist and possibly for a fee, you can have data read out which is stored only locally in the vehicle.

### Event Data Recorders

#### USA only:

This vehicle is equipped with an event data recorder (EDR). The main purpose of an EDR is to record, in certain crash or near crash-like situations, such as an air bag deployment or hitting a road obstacle, data that will assist in understanding how a vehicle's systems performed. The EDR is designed to record data related to vehicle dynamics and safety systems for a short period of time, typically 30 seconds or less.

The EDR in this vehicle is designed to record such data as:

- How various systems in your vehicle were operating;
- Whether or not the driver and passenger safety belts were buckled/fastened;

- How far (if at all) the driver was depressing the accelerator and/or brake pedal; and,
- How fast the vehicle was traveling.

These data can help provide a better understanding of the circumstances in which crashes and injuries occur. NOTE: EDR data are recorded by your vehicle only if a non-trivial crash situation occurs; no data are recorded by the EDR under normal driving conditions and no personal data (e.g., name, gender, age, and crash location) are recorded. However, other parties, such as law enforcement could combine the EDR data with the type of personally identifying data routinely acquired during a crash investigation.

Access to the vehicle and/or the EDR is needed to read data that is recorded by an EDR, and special equipment is required. In addition to the vehicle manufacturer, other parties that have the special equipment, such as law enforcement, can read the information by accessing the vehicle or the EDR.

EDR data may be used in civil and criminal matters as a tool in accident reconstruction, accident claims, and vehicle safety. Since the Crash Data Retrieval CDR tool that is used to extract data from the EDR is commercially available, Daimler VANS USA, LLC („DVUSA“) expressly disclaims any and all liability arising from the extraction of this information by unauthorized Mercedes-Benz personnel.

MBV will not share EDR data with others without the consent of the vehicle owners or, if the vehicle is leased, without the consent of the lessee. Exceptions to this representation include responses to subpoenas by law enforcement; by federal, state or local government; in connection with or arising out of litigation involving MBV or its subsidiaries and affiliates; or, as required by law.

Warning: The EDR is a component of the Restraint System Module. Tampering with, altering, modifying or removing the EDR component may result in a malfunction of the Restraint System Module and other systems.

State laws or regulations regarding EDRs that conflict with federal regulation are pre-empted. This means that in the event of such conflict, the federal regulation governs. As of Dec 2016, 17 states have enacted laws relating to EDRs.

### Copyright

#### Free and open source software

Information on licenses for free and open-source software used in your vehicle can be found on

the data storage medium in your vehicle document wallet and with latest updates on the following website:

<https://www.mercedes-benz.com/opensource>

### Registered trademarks



---

- Bluetooth® is a registered trademark of Bluetooth SIG Inc.
- DTS™ is a registered trademark of DTS, Inc.
- Dolby® and MLP™ are registered trademarks of DOLBY Laboratories.
- ESP® and PRE-SAFE® are registered trademarks of Mercedes-Benz Group AG.
- HomeLink® is a registered trademark of Genex Corporation.
- iPod® and iTunes® are registered trademarks of Apple Inc.
- Burmester® is a registered trademark of Burmester Audiosysteme GmbH.
- Microsoft® and Windows Media® are registered trademarks of Microsoft Corporation.
- SiriusXM® is a registered trademark of Sirius XM Radio Inc.
- HD Radio™ is a registered trademark of iBiquity Digital Corporation.
- Gracenote® is a registered trademark of Gracenote, Inc.
- ZAGAT Survey® and related brands are registered trademarks of Zagat Survey, LLC.

## Brief overview of most important points

### Basic information

Make sure that the following prerequisites in particular have been met, so that the components of the restraint system are able to provide the intended level of protection:

- Sit correctly (→ page 26).
- Fasten the seat belt correctly (→ page 27).
  - Function of the  seat belt warning lamp (→ page 28).
- The  restraint system warning lamp has not gone out after the self-test (→ page 28).

### For clear understanding

The chapter "Occupant safety" includes information on equipment, functions and behaviors that contribute directly to safety of vehicle occupants.

The information is structured as follows:

- **The most important information in brief:** in this chapter, you are provided with an overview of the relationship between the restraint system and the correct behavior of all vehicle occupants.
- **Specific information:** in further sections of the chapter "Occupant safety", you can find specific information on the equipment and functions of the restraint system.
- **Keyword directory:** you can also find certain subjects in this Operator's Manual using the keyword directory.

Information on the following subjects, among others, is not provided in the chapter "Occupant safety":

- Children in the vehicle (→ page 34)
- Driving and driving safety systems (→ page 119)
- Stowage areas (→ page 162)

### Defining generic terms clearly

The following generic terms are used in this Operator's Manual:

- **Occupant safety:** comprises the components and system functions which help to minimize, as much as possible, the stresses on and consequences for vehicle occupants during an accident.
- **Restraint system:** comprises those components which, along with the vehicle structure, help prevent vehicle occupants from potentially

coming into contact with parts of the vehicle interior. The seat belts and air bags, for example, are components of the restraint system.

- **Child restraint system:** you can find all information on this subject in the chapter "Children in the vehicle" (→ page 34).

### Be diligent

For the components of the restraint system to provide the intended level of protection, it is essential that you are seated correctly and that the seat belt is correctly secured.

Bear in mind that negligence concerning your seating position and fastening the seat belt can have serious consequences. Be diligent and make sure before starting every journey that all vehicle occupants are sitting correctly and have fastened their seat belts properly.

### Information on the correct seat position

The seat position must be correct in order for the components of the restraint system to provide the intended level of protection.

The seat position influences both the protection provided by the seat belt and the additional protection provided by the air bag.

A correct seat position in which the seat is nearly perfectly upright and a correctly fastened seat belt will reduce the risks posed by the air bag when it is deployed.

#### **WARNING** Risk of injury or death due to an incorrect seat position

If you deviate from the correct seat position, the air bag cannot provide its intended protective function.

Each vehicle occupant must make sure of the following.

- ▶ Put the seat in the correct position.
- ▶ Fasten seat belts correctly.
- ▶ Observe the following information.

In order for the restraint system to provide the intended level of protection, observe the following information:

- Before starting your journey, adjust your seat correctly (→ page 57).

When doing so, make sure you are able to fasten your seat belt correctly. The shoulder belt

strap must be routed forward from the seat belt outlet over the center of your shoulder.

- Keep your distance from the air bags, especially the front air bags. Set the driver's seat and front passenger seat as far back as possible while making sure the seat belt is fastened correctly.
- Make sure there are no people, animals or objects between the vehicle occupants and an air bag.
- If you are the driver, observe the following information on the correct position of the driver's seat (→ page 57).

Only hold the steering wheel by the steering wheel rim. This will allow the driver's air bag to deploy fully.

- Assume a nearly upright sitting posture, with your buttocks positioned as far back as possible in the gap between the seat cushion and the seat backrest.

Your back must rest as flatly and as firmly as possible against the seat backrest.

- While driving, do not lean forward and do not lean against the door or side window. You may otherwise be in the deployment area of the air bags.
- Sit with your feet resting on the floor, if possible. Your thighs are slightly supported by the seat cushion.

Do not put your feet on the cockpit, for example. Your feet may otherwise be in the deployment area of the air bag.

- Fasten the seat belt correctly.

### Notes on wearing the seat belt correctly

Always fasten your seat belt correctly before starting a journey. Only a seat belt which is worn correctly can provide the intended level of protection.

#### **▲ WARNING** Risk of injury or death due to incorrectly fastened seat belt

If the seat belt is not worn correctly, it cannot perform its intended protective function.

In addition, an incorrectly fastened seat belt can also cause injuries, for example, in the event of an accident or when braking or changing direction suddenly.

- ▶ Always ensure that all vehicle occupants have their seat belts fastened correctly and are sitting properly.

#### **▲ WARNING** Risk of injury or death when additional restraint systems are not used for persons with a smaller stature

Persons under 5 ft (1.50 m) tall cannot wear the seat belt correctly without a suitable additional restraint system.

- ▶ Always secure persons under 5 ft (1.50 m) tall in a suitable restraint system.

Each vehicle occupant must observe the following notes in particular:

- The seat belt must not be twisted.
- The shoulder belt strap must be routed forward from the seat belt outlet over the center of your shoulder.
- The shoulder belt strap should neither touch your neck nor be routed under your arm or behind your back.
- The lap belt must be routed as low down across the hips as possible.

In addition, push the lap belt down as far as possible across your hips and pull tight with the shoulder belt strap. Never route the lap belt across your abdomen.

- After being tightened, the shoulder belt strap and lap belt must fit snugly against the body.
- Particularly during pregnancy, the instructions for wearing the seat belt correctly must be followed consistently due to the change in stature.

The shoulder strap should run along the side of the abdomen.

- Avoid wearing bulky clothing, e.g. a winter coat.
- Never route the seat belt across sharp, pointed, abrasive or fragile objects.
- Only one person should use each seat belt at any one time.
- Never secure objects with a seat belt if the seat belt is being used by one of the vehicle's occupants.

Also ensure that no objects, e.g. cushions, are ever placed between a person and the seat.

### Fastening and adjusting seat belts

If the seat belt is pulled quickly or sharply, the seat belt retractor locks. The seat belt strap cannot be pulled out any further.

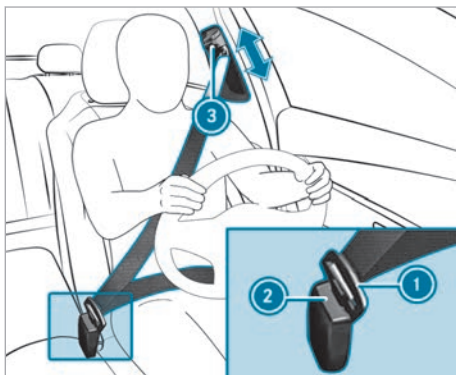

- ▶ Always engage seat belt tongue ① of the seat belt into seat belt buckle ② of the corresponding seat.
- ▶ **To adjust the seat belt height:** press button ③ on the seat belt outlet and slide the seat belt outlet to the desired position.
- ▶ **To engage the seat belt outlet:** release button ③ and ensure that the seat belt outlet engages.

**!** **NOTE** Deployment of components of the restraint system when the front passenger seat is unoccupied and a seat belt is buckled

When the front passenger seat is unoccupied and the seat belt tongue of the seat belt is engaged in the seat belt buckle, components of the restraint system may deploy unnecessarily on the front passenger side, e.g. the Emergency Tensioning Device.

- ▶ Only buckle the seat belts as intended.



**i** Observe the information on the child seat safety feature of the seat belt (→ page 36).

### Function of the restraint system warning lamp

When the vehicle is switched on, a self-test is performed, during which the  restraint system warning lamp lights up. It goes out no later than a few seconds after the vehicle is started. The

components of the restraint system are then functional.

A malfunction has occurred in the restraint system in the following cases:

- The  restraint system warning lamp does not light up or lights up continuously when the vehicle is switched on.
- The  restraint system warning lamp lights up continuously or repeatedly during a journey.

If components of the restraint system have been deployed, the  restraint system warning lamp lights up continuously.

**!** **WARNING** Risk of injury due to malfunctions in the restraint system

Components in the restraint system may be activated unintentionally or not deploy as planned in an accident.

- ▶ Have the restraint system checked and repaired immediately at a qualified specialist workshop.

If the restraint system is malfunctioning, the automatic high-voltage emergency shutoff may not function.

**!** **DANGER** Risk of fatal injuries due to malfunctions of the automatic high-voltage emergency shutoff

In the event of an accident, the high-voltage on-board electrical system may not be deactivated as intended.

You may be electrocuted if you touch the damaged component parts of the high-voltage on-board electrical system.

- ▶ Have the automatic high-voltage emergency shutoff checked and repaired immediately at a qualified specialist workshop.
- ▶ After an accident, switch off the vehicle immediately.

Mercedes-Benz recommends that you have the vehicle towed to a qualified specialist workshop.

### Function of the seat belt warning lamp

The  seat belt warning lamp in the instrument cluster display reminds you that all vehicle occupants must fasten their seat belts correctly.

The  seat belt warning lamp lights up for six seconds each time the vehicle is switched on.

A warning tone may also sound.

After the vehicle is started, the seat belt warning goes out as soon as the driver's and the front passenger's seat belts are fastened.

While driving, the seat belt warning lights up in the following cases:

- if the vehicle's speed is higher than 15 mph (25 km/h) and the driver's or front passenger's seat belt is not fastened
- if the driver or front passenger unfastens their seat belt during the journey

### Information on the child restraint system

When installing a child restraint system, observe the notes in "Children in the vehicle" (→ page 34).

#### Notes on the child restraint system on the front passenger seat

**⚠ WARNING** Risk of injury or fatal injuries if the front passenger air bag is enabled

If the front passenger air bag is enabled, a child on the front passenger seat may be struck by the front passenger air bag in the event of an accident.

▶ NEVER use a rearward-facing child restraint system on a seat with an ENABLED FRONT AIR BAG. This can result in the DEATH of or SERIOUS INJURY to the CHILD.

Also pay particular attention to the notes on rearward-facing or forward-facing child restraint systems on the front passenger seat (→ page 36).

### Information on the automatic functions of the restraint system

#### Overview of the automatic measures after an accident

Depending on the type and severity of the accident, and depending on the vehicle's equipment, the following measures can be implemented, for example:

- automatic braking (post-collision brake)
- activating the hazard warning lights

- triggering an automatic emergency call (→ page 178)
- switching off the drive system and high-voltage on-board electrical system

To restart the vehicle, switch the vehicle off and on again (→ page 96). Depending on the type and severity of an accident, the vehicle may no longer start.

- unlocking the vehicle doors
- lowering the front side windows
- switching on the interior lighting

#### Function of the post-collision brake after an accident

##### Function of the post-collision brake

Depending on the accident situation, the post-collision brake can minimize the severity of a further collision or even avoid it.

If an accident has been detected, the post-collision brake can implement automatic braking. When the vehicle has come to a standstill, the electric parking brake is automatically applied.

The driver can cancel automatic braking by taking the following actions:

- braking more strongly than automatic braking
- fully depressing the accelerator pedal with force

### Purpose and function of the restraint system

#### Overview of deployment situations (restraint system)

Make sure that the following prerequisites in particular have been met, so that the components of the restraint system are able to provide the intended level of protection:

- Sit correctly (→ page 26).
- Fasten the seat belt correctly (→ page 27).
  - Function of the seat belt warning lamp (→ page 28).
- The  restraint system warning lamp is not on after the self-test (→ page 28).

Depending on the detected deployment situation, the components of the restraint system can be activated or deployed independently of one another:

- Emergency Tensioning Device: frontal impact, rear impact, side impact, overturning, rollover
- Driver's air bag, front passenger air bag: frontal impact
- Side air bag: side impact
- Window air bag: side impact, overturning, rollover, frontal impact

The installation location of an air bag is identified by the AIRBAG symbol (→ page 33).

Observe the information on the function of the restraint system (→ page 30).

#### Information on how the restraint system works

How the restraint system functions depends on the severity of the impact detected and the apparent type of accident.

For more information about types of accidents, see "Overview of deployment situations" (→ page 29).

The activation thresholds for the components of the restraint system are determined based on the evaluation of the sensor values measured at various points in the vehicle. This process is anticipatory in nature. The triggering/deployment of the components of the restraint system must take place in good time at the start of the collision.

Factors that can be seen and measured only after a collision has occurred do not play a decisive role in the deployment of an air bag, nor do they provide an indication of air bag deployment.

The vehicle may be deformed significantly without an air bag being deployed. This is the case if only parts that are relatively easily deformed are affected and the rate of vehicle deceleration is not high. Conversely, an air bag may be deployed even though the vehicle suffers only minor deformation. If very rigid vehicle parts, such as longitudinal members, are hit, the vehicle deceleration may be high enough for this to happen.

Depending on the apparent type of accident and the detected deployment situation, Emergency Tensioning Devices and/or air bags supplement the protection offered by a correctly worn seat belt.

Vehicles with a front passenger bench seat: the Emergency Tensioning Device on the front

passenger seat will be triggered whether or not the seat belt tongue is engaged in the seat belt buckle.

When enabled, an air bag can provide additional protection for the respective vehicle occupant.

Possible protection per air bag:

- Driver's air bag, front passenger air bag: head and thorax
- Window air bag: head
- Side air bag: thorax and pelvis

However, no system available today can completely rule out injuries and fatalities in every accident. In particular, the seat belt and air bag generally do not protect against objects penetrating the vehicle from the outside. It is also not possible to completely rule out the risk of injury caused by the air bag deploying.

Mercedes-Benz recommends that you have the vehicle towed to a qualified specialist workshop after an accident. Take this into account, particularly if a Emergency Tensioning Device has been triggered or an air bag deployed.

If the Emergency Tensioning Devices are triggered or an air bag is deployed, you will hear a bang, and a small amount of powder may also be released:

- The bang will not generally affect your hearing.
- In general, the powder released is not hazardous to health but may cause short-term breathing difficulties to persons suffering from asthma or other pulmonary conditions.

Provided it is safe to do so, leave the vehicle immediately or open the window in order to prevent breathing difficulties.

Air bags and pyrotechnic Emergency Tensioning Devices contain perchlorate material, which may require special handling or environmental protection measures. National guidelines regarding waste disposal must be observed. In California, see <https://dtsc.ca.gov/>. You can use the search function to find information on perchlorate, for example.

### Information on the limited protection provided by the restraint system

#### Risk due to the incorrect behaviour of vehicle occupants

Every vehicle occupant must make sure of the following in particular:

- They observe the information on the correct seat position (→ page 26).
- There are no heavy, pointed, sharp-edged or fragile objects in the pockets of their clothing. Stow such objects in a suitable place.

#### **⚠ WARNING** Risk of injury or death due to an incorrect seat position

The seat belt does not offer the intended level of protection if you have not moved the seat backrest to an almost vertical position.

In particular, you could slip beneath the seat-belt and become injured.

- ▶ Adjust the seat properly before beginning your journey.
- ▶ Always ensure that the seat backrest is in an almost vertical position and that the shoulder belt is routed across the center of your shoulder.

#### Risk due to objects in the vehicle interior

Every vehicle occupant must make sure of the following in particular:

- They observe the information on the correct seat position (→ page 26).
- There are no objects between the seat, door and door pillar (B-pillar).
- There are no hard objects, e.g. coat hangers, hanging on the grab handles or coat hooks.
- There are no heavy, pointed, sharp-edged or fragile objects in the pockets of their clothing. Stow such objects in a suitable place.

#### **⚠ WARNING** Risk of injury or death due to blocked seat belt buckle or seat belt anchorage

Objects next to the front seat that block the seat belt buckle or the moving seat belt anchorage on the front seat impair the function of the Emergency Tensioning Devices.

- ▶ Before starting the journey, make sure that there are no objects around the seat

belt buckle or between the front seat and door.

#### **⚠ WARNING** Risk of injury from objects in the deployment area of an airbag

Objects in the deployment area of an airbag can hinder or prevent the correct deployment of the airbag.

The airbag may then deploy in an uncontrolled manner and may even cause additional injuries to the vehicle occupants by deploying. This may be the case in particular if the airbag is integrated into the seat.

- ▶ Always stow and secure objects correctly.
- ▶ Before commencing your journey, make sure that no objects are stowed in the deployment area of an airbag.

The installation location of an air bag is identified by the AIRBAG symbol (→ page 33).

#### Risk due to the installation of accessories

Do not attach accessories such as mobile navigation devices, mobile phones or cup holders within the deployment area of an air bag, e.g. by the cockpit, by the door, by the side window or by the side trim.

In addition, no connecting cables, tensioning straps or retaining straps may be routed or attached to the vehicle within the deployment area of an air bag. Always comply with the accessory manufacturer's installation instructions and, in particular, the notes on suitable places for installation.

#### **⚠ WARNING** Risk of injury or death due to unsuitable protective covers

Unsuitable protective covers mean that air bags can no longer protect vehicle occupants as they are designed to do.

- ▶ Use only protective covers approved by Mercedes-Benz for the seat in question.

#### Risk due to pets in the vehicle interior

#### **⚠ WARNING** Risk of accident and injury due to animals left unsecured or unattended in the vehicle

If you leave animals in the vehicle unattended or unsecured, they could possibly press buttons or switches.

An animal may:

- Activate vehicle equipment and become trapped, for example
- Switch systems on or off and endanger other road users

Unsecured animals may be thrown around in the vehicle in the event of an accident or sudden steering and braking maneuvers and injure vehicle occupants in the process.

- ▶ Never leave animals in the vehicle unattended.
- ▶ Always correctly secure animals while driving, e.g. using a suitable animal carrier.

### ■ Risk due to modification, damage or wear to the components of the restraint system

**⚠ WARNING** Risk of injury or death due to modifications to the restraint system

Vehicle occupants may no longer be protected as intended if alterations are made to the restraint system.

- ▶ Never alter the parts of the restraint system.
- ▶ Never tamper with the wiring or any electronic component parts or their software.

If it is necessary to modify the vehicle to accommodate a person with physical disabilities, contact an authorized Mercedes-Benz Center for details.

USA only: for further information, contact our Customer Assistance Center at 1-800-FOR-MERCEDES (1-800-367-6372).

**⚠ WARNING** Risk of injury or death due to damaged or modified seat belts

Seat belts cannot provide protection in the following situations:

- The seat belt is damaged, has been modified, is extremely dirty, bleached or dyed
- The seat belt buckle is damaged or extremely dirty
- Modifications have been made to the Emergency Tensioning Device, seat belt anchorage or seat belt retractor

Seat belts may sustain non-visible damage in an accident, e.g. due to glass splinters.

Modified or damaged seat belts could tear or fail in the event of an accident, for example.

Modified Emergency Tensioning Devices could accidentally trigger or fail to function as intended.

- ▶ Never modify the seat belt system, for example the seat belt, seat belt buckle, Emergency Tensioning Device, seat belt anchorage and seat belt retractor.
- ▶ Make sure that the seat belts are undamaged, not worn and clean.
- ▶ Always have the seat belts checked immediately after an accident at a qualified specialist workshop.

Only use seat belts which have been approved for your vehicle by Mercedes-Benz.

**⚠ WARNING** Risk of injury due to modifications to the cover of an airbag

If you change the cover of an airbag or attach objects, e.g. even stickers, to it, the airbag may no longer function as intended.

- ▶ Never modify the cover of an airbag.
- ▶ Do not attach any objects to the cover.

The installation location of an air bag is identified by the air bag symbol (→ page 33).

**⚠ WARNING** Risk of injury due to malfunctioning sensors in the door

The function of the airbags can be impaired due to modifications or incorrect work performed on the doors or door trim, or if the doors are damaged.

- ▶ Never modify the doors or parts of the doors.
- ▶ Always have work on the doors or door trim carried out at a qualified specialist workshop.

### ■ Risk due to components of the restraint system that have already been deployed

Mercedes-Benz recommends that you have the vehicle towed to a qualified specialist workshop after an accident.

**⚠ WARNING** Risk of burns from hot air bag components

The air bag parts are hot after an air bag has been deployed.

- ▶ Do not touch the air bag parts.
- ▶ Have a deployed air bag replaced at a qualified specialist workshop as soon as possible.

**⚠ WARNING** Risk of injury due to deployed airbag

A deployed airbag no longer offers any protection.

- ▶ Have the vehicle towed to a qualified specialist workshop in order to have the deployed airbag replaced.

Have deployed air bags replaced immediately.

**⚠ WARNING** Risk of injury or death from deployed pyrotechnic Emergency Tensioning Devices

Pyrotechnic Emergency Tensioning Devices that have been deployed are no longer operational and are unable to perform their intended protective function.

- ▶ Therefore, have deployed pyrotechnic Emergency Tensioning Devices immediately replaced at a qualified specialist workshop.

## Seat belts

### Unfastening the seat belts

- ▶ Press the release button on the seat belt buckle and guide the seat belt back with the seat belt tongue.

**! NOTE** Damage caused by trapping the seat belt

If an unused seat belt is not fully retracted, it may become trapped in the door or in the seat mechanism.

- ▶ Always ensure that an unused seat belt is fully retracted.

## Airbags

### Overview of air bags

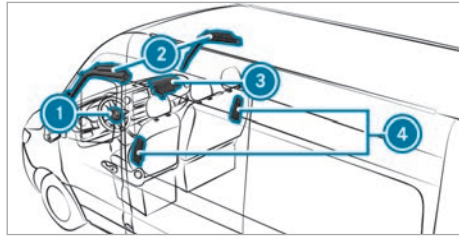

- ① Driver's air bag
- ② Window curtain air bag
- ③ Co-driver air bag
- ④ Side impact air bag

The installation location of an air bag is identified by the AIRBAG symbol.

Observe the information in "Overview of deployment situations" (→ page 29).

## Brief overview of most important points

### Safely carrying children in the vehicle

Always observe the following when carrying children:

- Never leave children unattended in the vehicle (→ page 34).
- Properly secure children up to a height of 5 ft (1.50 m) or under 12 years of age on the appropriate seat with a suitable and approved child restraint system, and secure infants in a rearward-facing child restraint system.
- Observe the child restraint system manufacturer's installation instructions.

#### Front passenger seat

Attachment system:

-  Seat belt on vehicle seat (→ page 37)

## Important safety notes

### Basic information

#### Be diligent

Bear in mind that negligence when securing a child in the child restraint system can have serious consequences. Always be diligent and secure a child carefully before each journey.

Infants and children must never travel sitting on the lap of a vehicle occupant.

To improve protection for children under 12 years of age or less than 5 ft (1.50 m) in height, Mercedes-Benz recommends that you make sure you observe the following information:

- Always secure the child in a child restraint system suitable for this Mercedes-Benz vehicle.
- The child restraint system must be appropriate to the age, weight and size of the child.
- The vehicle seat must be suitable for the child restraint system to be installed:

Accident statistics show that children secured on the rear seats are generally safer than children secured on the front seats. For this reason, Mercedes-Benz strongly advises that you install a child restraint system on a rear seat, if there are rear seats.

#### The generic term child restraint system

The generic term "child restraint system" is used in this Operator's Manual. A child restraint system can be e.g.:

- an baby car seat
- a rearward-facing child seat
- a forward-facing child seat
- a child booster seat – Mercedes-Benz recommends using a child booster seat **with** a seat backrest and seat belt guide

#### Observe laws and regulations

Always observe the legal requirements when using a child restraint system in the vehicle.

#### Attachment systems for child restraint systems in the vehicle

Only use the following attachment systems for child restraint systems:

- the seat belt system of the vehicle

A booster seat may be necessary to achieve proper seat belt positioning for children over 40 lbs (18 kg) in weight or until they reach a height at which a three-point seat belt can be installed properly without a booster seat.

Mercedes-Benz recommends a child booster seat with a backrest and seat belt guides.

#### Observe standards for child restraint systems

All child restraint systems must meet the following standards:

- U.S. Federal Motor Vehicle Safety Standards 213
- Canadian Motor Vehicle Safety Standards 213

Confirmation that the child restraint system complies with the standards can be found on an information label on the child restraint system. This confirmation can also be found in the installation instructions that are included with the child restraint system.

### Important warning notices

#### Always secure a child restraint system correctly

**⚠ WARNING** Risk of injury or death due to incorrect installation of the child restraint system

The child can then not be protected or restrained as intended.

- ▶ Be sure to comply with the manufacturer's installation instructions for the child restraint system and its correct use.
- ▶ Make sure that the entire base of the child restraint system always rests on the sitting surface of the seat.
- ▶ Never place objects (e.g. cushions) under or behind the child restraint system.
- ▶ Use child restraint systems only with the original cover designed for them.
- ▶ Always replace damaged covers with genuine covers.

- Always observe the vehicle-specific information.
  - Securing the child restraint system with the seat belt (→ page 37).
- Observe the warning labels in the vehicle interior and on the child restraint system.

**⚠ WARNING** Risk of injury or death due to unsecured child restraint systems in the vehicle

If the child restraint system is incorrectly mounted or unsecured, it may come loose.

The child can then not be protected or restrained as intended.

Unused child restraint systems could be flung around and hit vehicle occupants.

- ▶ Always comply with the manufacturer's installation instructions for the child restraint system and its correct use.
- ▶ Always fit child restraint systems correctly, even if they are transported in the vehicle unused.

#### Do not modify the child restraint system

**⚠ WARNING** Risk of injury due to modifications to the child restraint system

The child restraint system can no longer function properly. This poses an increased risk of injury.

- ▶ Never modify a child restraint system.
- ▶ Only affix accessories which have been specially approved for this child restraint system by the child restraint system's manufacturer.

#### Only use child restraint systems which are in proper working condition

**⚠ WARNING** Risk of injury or death caused by the use of damaged child restraint systems

Child restraint systems or their retaining systems that have been subjected to stress in an accident may not be able to perform their intended protective function.

It may be the case that the child cannot be properly restrained.

- ▶ Always immediately replace child restraint systems that have been damaged or involved in an accident.
- ▶ Have the securing systems for the child restraint systems checked at a qualified specialist workshop before installing a child restraint system again.

#### Avoid direct sunlight

**⚠ WARNING** Risk of burns when the child seat is exposed to direct sunlight

If the child restraint system is exposed to direct sunlight or heat, parts could heat up excessively.

Children could suffer burns from these parts, particularly the metallic parts of the child restraint system.

- ▶ Always make sure that the child restraint system is not exposed to direct sunlight.
- ▶ Cover the child restraint system with a blanket, for example.
- ▶ If the child restraint system has been exposed to direct sunlight, allow it to cool before securing a child into it.
- ▶ Never leave children unattended in the vehicle.

#### Observe when stopping or parking

**⚠ WARNING** Risk of fatal injury due to exposure to extreme heat or cold in the vehicle

If persons, particularly children, are subjected to prolonged exposure to intense heat or cold, there is a risk of severe injury or even death.

- ▶ Never leave persons, particularly children, unattended in the vehicle.

**⚠ WARNING** Risk of accident and injury due to children left unattended in the vehicle

If you leave children unattended in the vehicle, they could, in particular:

- open doors, thereby endangering other persons or road users.
- get out and be struck by oncoming traffic.
- operate vehicle equipment and become trapped, for example.

In addition, the children could also set the vehicle in motion by, for example:

- releasing the parking brake.
- changing the gearbox position.
- starting the vehicle.

- ▶ Never leave children unattended in the vehicle.
- ▶ When leaving the vehicle, always take the key with you and lock the vehicle.
- ▶ Keep the key out of reach of children.

### Important notes on rearward-facing child restraint systems on the front passenger seat

The front passenger air bag cannot be disabled. NEVER use a rearward-facing child restraint system on a seat with an ENABLED FRONT AIR BAG. This may result in DEATH or SERIOUS INJURY to the child.

Always observe the information on the safe transportation of children (→ page 34).

### Securing the child restraint system

#### Adjusting the seat correctly

 Depending on the vehicle equipment, always observe the following when installing a belt-secured child restraint system on the front passenger seat:

- ▶ **When using a front-facing child restraint system with integrated child seat belt:** remove the head restraint from the respective seat, if possible. After the child restraint system has been removed, immediately replace the head restraint and adjust correctly.
- ▶ Ensure that the seat backrest of front-facing child restraint system is lying as flat as possi-

ble against the backrest of the front passenger seat.

- ▶ The child restraint system must not be put under strain between the roof and the seat surface and/or be installed facing in the wrong direction.
- ▶ Adjust the vehicle head restraints so that the child restraint system is not put under strain by the head restraint.
- ▶ Never place objects (e.g. cushions) under or behind the child restraint system.
- ▶ Set the front passenger seat as far back as possible and move the seat into the highest position possible. Always make sure that the shoulder belt strap is correctly routed from the seat belt outlet of the vehicle to the shoulder belt guide on the child restraint system. The shoulder belt strap must be routed forwards from the seat belt outlet and, where possible, downwards to the child restraint system.
- ▶ Fully retract the seat cushion length adjustment.
- ▶ Set the seat cushion inclination in such a way that the front edge of the seat cushion is in the highest position and the rear edge of the seat cushion is in the lowest position.
- ▶ Set the seat backrest to the most vertical position possible.

### Activating or deactivating the child seat safety feature of the seat belt

**⚠ WARNING** Risk of injury or death if a seat belt is unfastened while the vehicle is in motion

If the seat belt is released while the vehicle is in motion, the special seat belt retractor is deactivated and the child restraint system is no longer correctly secured. The seat belt is drawn in slightly by the inertia reel and cannot be immediately closed again.

- ▶ Stop the vehicle immediately in accordance with the traffic conditions.
- ▶ Activate the special seat belt retractor again and correctly secure the child restraint system.

When activated, the child seat safety feature ensures that the seat belts of the front passenger seat do not slacken once the child restraint system is secured.

The seat belts on the following seats are equipped with a child seat safety feature:

- Front passenger seat
- Rear seats

#### Installing a child restraint system

- ▶ When installing a child restraint system, always observe the manufacturer's installation and operating instructions for the child restraint system used, as well as the notes in this Operator's Manual.
- ▶ Pull the seat belt smoothly from the seat belt outlet.
- ▶ Engage the seat belt tongue in the seat belt buckle.

#### Activating the child seat safety feature

- ▶ Extend the seat belt fully and then allow the inertia reel to retract the belt. When the child seat safety feature is activated, you should hear a ratcheting sound.
- ▶ Push the child restraint system down until the seat belt is tight.

#### Deactivating the child seat safety feature

- ▶ Press the release button of the seat belt buckle.
- ▶ Hold the seat belt tongue and guide it back to the seat belt outlet.

#### Securing the child restraint system with the seat belt

The seat belts on the following seats are equipped with a child seat safety feature:

- Front passenger seat

When enabled, the child seat safety feature ensures that the seat belts of the front passenger seat do not slacken once the child restraint system is secured.

- ▶ Install the child restraint system. The entire base of the child restraint system must always rest on the sitting surface of the seat.
- ▶ Always make sure that the shoulder belt strap is correctly routed from the seat belt outlet of the vehicle to the shoulder belt guide on the child restraint system. The shoulder belt strap must be routed forwards from the seat belt outlet and, where

possible, downwards to the child restraint system.

- ▶ If necessary, adjust the seat belt outlet and the front passenger seat as appropriate.

#### Child safety locks

##### Activating or deactivating child safety locks for the sliding doors

**⚠ WARNING** Risk of accident and injury due to children left unattended in the vehicle

If you leave children unattended in the vehicle, they could, in particular:

- open doors, thereby endangering other persons or road users.
- get out and be struck by oncoming traffic.
- operate vehicle equipment and become trapped, for example.

In addition, the children could also set the vehicle in motion by, for example:

- releasing the parking brake.
- changing the gearbox position.
- starting the vehicle.

- ▶ Never leave children unattended in the vehicle.
- ▶ When leaving the vehicle, always take the key with you and lock the vehicle.
- ▶ Keep the key out of reach of children.

**⚠ WARNING** Risk of fatal injury due to exposure to extreme heat or cold in the vehicle

If persons, particularly children, are subjected to prolonged exposure to intense heat or cold, there is a risk of severe injury or even death.

- ▶ Never leave persons, particularly children, unattended in the vehicle.

**⚠ WARNING** Risk of accident and injury due to children left unattended in the vehicle

If children are traveling in the vehicle, they could, in particular:

- Open doors, thereby endangering other persons or road users
- Get out and be struck by oncoming traffic
- Operate vehicle equipment and become trapped, for example

- ▶ Always activate the child safety locks installed if children are traveling in the vehicle.
- ▶ Never leave children unattended in the vehicle.
- ▶ When leaving the vehicle, always take the SmartKey with you and lock the vehicle.

The following doors have child safety locks:

- Sliding doors

The child safety locks on the doors secure each door separately. The doors can no longer be opened from the inside (except the electric sliding door). The door can be opened from the outside when the vehicle is unlocked.

The electric sliding door can be opened at any time using the button on the center console.

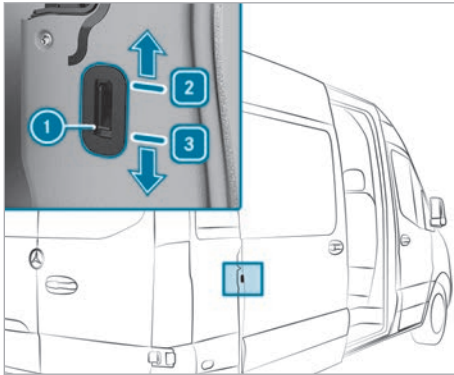

Example: sliding door child safety lock

- ▶ Slide the child safety lock latch ① into position ② (locked) or ③ (unlocked).
- ▶ Ensure that the child safety locks are working properly.

## SmartKey

### Notes on the key's radio connections

**⚠ DANGER** Risk of fatal injury to persons with medical devices due to electromagnetic radiation when using the start/stop button

Persons with medical devices, e.g. pacemakers or defibrillators:

There is a radio connection between the key and the vehicle.

The function of a medical device can be impaired.

- ▶ Before operating the vehicle, consult your doctor or the manufacturer of the medical device about any possible effects from such systems.

### Detection range of KEYLESS-START function antenna

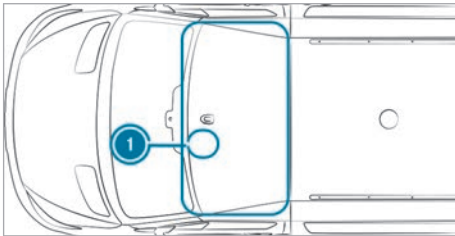

- ① Position of key holder when the antenna detection range is reduced (→ page 98)

### Overview of key functions

**⚠ WARNING** Risk of accident and injury due to children left unattended in the vehicle

If you leave children unattended in the vehicle, they could, in particular:

- open doors, thereby endangering other persons or road users.
- get out and be struck by oncoming traffic.
- operate vehicle equipment and become trapped, for example.

In addition, the children could also set the vehicle in motion by, for example:

- releasing the parking brake.
  - changing the gearbox position.
  - starting the vehicle.
- ▶ Never leave children unattended in the vehicle.
  - ▶ When leaving the vehicle, always take the key with you and lock the vehicle.
  - ▶ Keep the key out of reach of children.

**⚠ NOTE** Damage to the SmartKey caused by magnetic fields

- ▶ Keep the SmartKey away from strong magnetic fields.

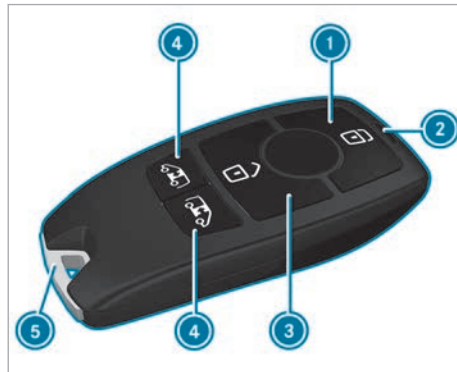



- ① To lock
- ② Indicator lamp
- ③ To unlock
- ④ To unlock the cargo compartment (sliding doors and rear-end doors) / to unlock and open/close the electric sliding doors
- ⑤ Emergency key

The key's factory setting enables you to centrally lock and unlock the following components:

- the driver's door and front passenger door
  - the sliding doors
  - the rear-end doors
  - the socket flap
- ⓘ If you do not open the vehicle within approximately 40 seconds of unlocking, the vehicle will lock again and anti-theft protection will be armed again.

Do not store the key together with electronic devices or metallic objects. This could impair the key's functionality.



- ❗ If the indicator lamp ② does not light up when you press the button  or , the battery is discharged.

Replace the key battery (→ page 40).

### Changing the unlocking settings

The key has the following adjustable unlocking functions:

- unlocking the vehicle centrally
- unlocking the driver's door (vehicles without partition or with cab)
- unlocking the driver's door and front passenger door (vehicles with partition)



▶ **To switch between settings:** press and hold the buttons  and  at the same time for approximately six seconds until the indicator lamp flashes twice.

▶ **To unlock the vehicle centrally when the unlocking function is selected for the driver's door or the driver's and front passenger door:** press the  button a second time.

### Reducing energy consumption of the key

#### Deactivate key function

If you do not use the vehicle or a key for an extended period of time, you can also deactivate the function of the key to reduce energy consumption of the respective key.

- ▶ Press and hold the key button .
- ▶ With the key button  pressed, immediately press the key button  twice in quick succession.  
The indicator lamp of the key lights up once briefly and then again for a longer period.

#### Activate the key function

- ▶ Press any button on the key.
- ❗ If the key in the storage compartment is in emergency operation mode for start-up, the key function is activated automatically (→ page 98).

### Removing and inserting the emergency key

#### Removing

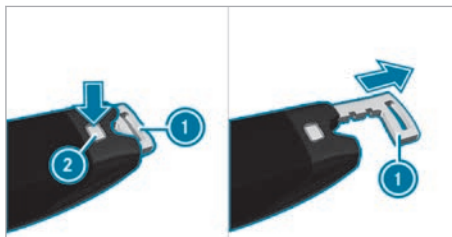

- ▶ Press the release knob ②.  
The emergency key ① is pushed out slightly.
- ▶ Pull the emergency key ① out completely.

#### Inserting

- ▶ Press the release knob ②.
- ▶ Slide the emergency key ① in completely until it engages.
- ❗ The Anti-Theft Alarm system (ATA) is triggered when you unlock and open the vehicle using the emergency key (→ page 54).

### Replacing the key battery

**⚠ DANGER** Risk of fatal injury due to swallowing batteries

Batteries contain toxic and corrosive substances. If batteries are swallowed or otherwise enter the body, severe internal burns can occur within two hours.

There is a risk of fatal injury!

- ▶ Keep the batteries out of the reach of children.
- ▶ If the lid and/or the battery compartment do not close securely, stop using the key and keep it away from children.
- ▶ If batteries are swallowed or otherwise enter the body, seek immediate medical attention.

**🌿 ENVIRONMENTAL NOTE** Environmental damage due to improper disposal of batteries



Batteries contain pollutants. It is illegal to dispose of them with the household rubbish.



Dispose of batteries in an environmentally responsible manner. Take discharged batteries to a qualified specialist workshop or to a collection point for used batteries.

#### Requirements:

- You need a CR 2032 lithium cell battery (3 V).

Mercedes-Benz recommends that you have the battery replaced by a qualified specialist workshop.

- Remove the emergency key (→ page 40).



Example image

- Press the release knob ② all the way down and slide open the cover ①.
- Pull out the battery compartment ③ and remove the flat battery.
- Insert the new battery into the battery compartment ③. Observe the positive terminal marking in the battery compartment and on the battery.
- Insert the battery compartment ③.
- Re-attach the cover ① and push it closed until it engages.
- Slide the emergency key in completely until it engages (→ page 40).

#### Rectifying problems with the key

**You can no longer lock or unlock the vehicle.**

Possible causes:

- The key battery is at low capacity or is flat.
- Check the battery via the indicator lamp (→ page 39).

- Replace the key battery as required (→ page 40).
- Use the replacement key.
- Use the emergency key to lock and unlock the vehicle (→ page 44).
- Have the key checked at a qualified specialist workshop.

**There is interference from a powerful radio signal source.**

Possible causes if the function of the key is impaired:

- high voltage power lines
- mobile phones
- electronic devices (notebooks, tablets)
- shielding due to metal objects or induction loops for electrical gate systems or automatic barriers
- Ensure that there is sufficient distance between the key and the potential source of interference.

**You have lost a key.**

- Have the key deactivated at a qualified specialist workshop.
- If necessary, have the locks changed as well.

## Doors

### Unlocking and opening the door from inside

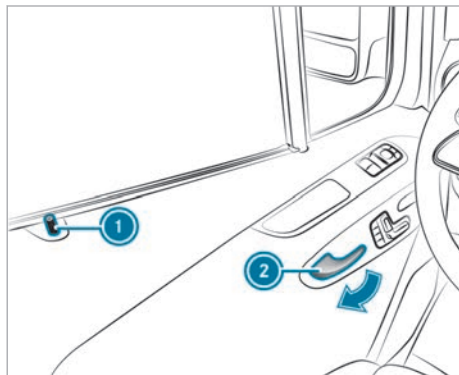

- To unlock and open the front door:** pull the door handle ②. The safety pin ① pops up when the door is unlocked.

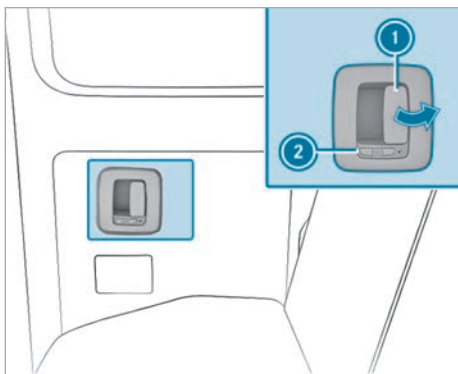

The  symbol indicates that the rear door is unlocked.

▶ **To unlock and open the rear door:** Pull the release lever ① and open the rear door. When the door unlocks, the catch ② moves forward.

The  symbol is visible.

▶ **To close:** Pull the rear door closed using the door handle.

▶ **To lock:** slide back the catch ②. The  symbol is visible.

### Centrally locking and unlocking the door from the inside

**⚠ WARNING** Risk of accident and injury due to children left unattended in the vehicle

If you leave children unattended in the vehicle, they could, in particular:

- open doors, thereby endangering other persons or road users.
- get out and be struck by oncoming traffic.
- operate vehicle equipment and become trapped, for example.

In addition, the children could also set the vehicle in motion by, for example:

- releasing the parking brake.
- changing the gearbox position.
- starting the vehicle.

▶ Never leave children unattended in the vehicle.

▶ When leaving the vehicle, always take the key with you and lock the vehicle.

▶ Keep the key out of reach of children.

**⚠ WARNING** Risk of fatal injury due to exposure to extreme heat or cold in the vehicle

If persons, particularly children, are subjected to prolonged exposure to intense heat or cold, there is a risk of severe injury or even death.

▶ Never leave persons, particularly children, unattended in the vehicle.

You can use the central locking buttons to centrally lock and unlock the entire vehicle from the inside.

The central locking buttons are located in the driver's and front passenger doors.

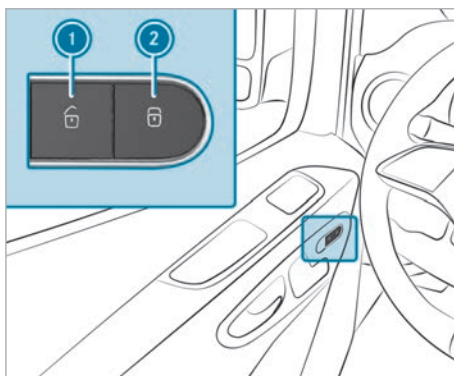

Central locking buttons (vehicles with electrically adjustable front seats)

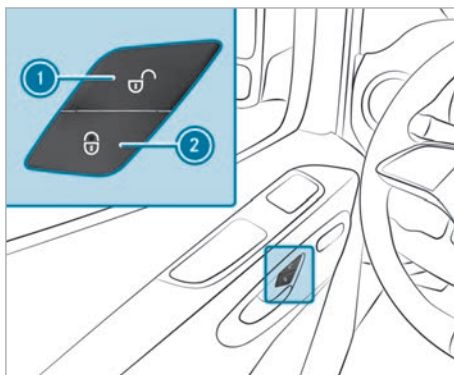

Central locking buttons (vehicles with manually adjustable front seats)

- ▶ **To unlock:** with the doors closed, press the button ①.
- ▶ **To lock:** with the doors closed, press the button ②.

### Activating/deactivating the automatic lock

#### Requirements:

- The power supply or the vehicle has been switched on.
- The doors are closed.

When the automatic lock is activated and the vehicle is traveling at a speed above 9 mph (15 km/h), the vehicle will be locked automatically.

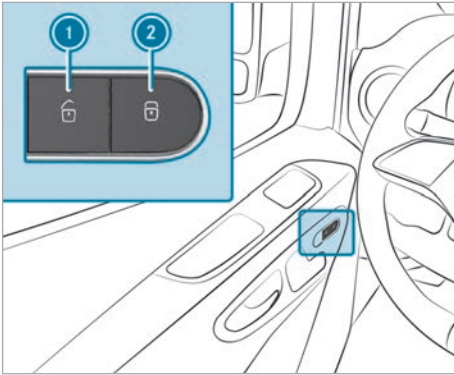

Central locking buttons (vehicles with electrically adjustable front seats)

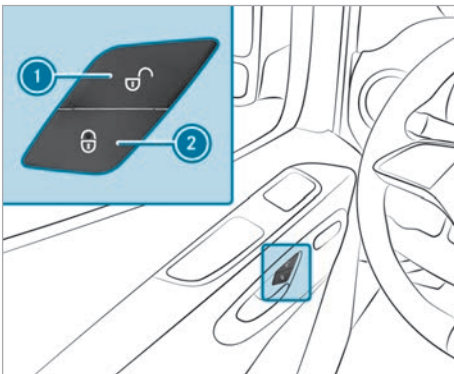

Central locking buttons (vehicles with manually adjustable front seats)

If the vehicle is being tested on a roller dynamometer, there is a risk of being locked out when the function is activated.

- ▶ **To activate:** press and hold the button ② until you hear an acoustic signal.
- ▶ **To deactivate:** press and hold the button ① until you hear an acoustic signal.

### Automatic locking after closing the last door

**⚠ WARNING** Risk of fatal injury due to exposure to extreme heat or cold in the vehicle

If persons, particularly children, are subjected to prolonged exposure to intense heat or cold, there is a risk of severe injury or even death.

- ▶ Never leave persons, particularly children, unattended in the vehicle.

**⚠ WARNING** Risk of accident and injury due to children left unattended in the vehicle

If you leave children unattended in the vehicle, they could, in particular:

- open doors, thereby endangering other persons or road users.
- get out and be struck by oncoming traffic.
- operate vehicle equipment and become trapped, for example.

In addition, the children could also set the vehicle in motion by, for example:

- releasing the parking brake.
- changing the gearbox position.
- starting the vehicle.

- ▶ Never leave children unattended in the vehicle.
- ▶ When leaving the vehicle, always take the key with you and lock the vehicle.
- ▶ Keep the key out of reach of children.

**⚠ WARNING** Accident- and risk of injury with unsecured or unattended animals in parked vehicle

If you leave animals in the vehicle unattended or unsecured, they could possibly press buttons or switches.

An animal may:

- Activate vehicle equipment and become trapped, for example.
- Switch systems on or off and endanger other road users

- ▶ Never leave animals in the vehicle unattended.
- ▶ Always secure animals properly, e.g. with a suitable animal transport box.

After leaving the vehicle and closing the last door, the vehicle is automatically locked. This also applies if the key is still in the vehicle.

There is a risk of locking oneself out. The vehicle can only be opened again with a vehicle key.

- Always carry the vehicle key with you when leaving the vehicle.
- ❗ If the vehicle is locked and the only available key is in the vehicle, notify a qualified specialist workshop.



Warning information, according to the respective version of driver's door, partition or sliding door

### Unlocking and locking the driver's door with the emergency key

- ❗ If you want to lock the vehicle completely with the emergency key, press the button for the locking mechanism from inside first with the driver's door open. Then lock the driver's door with the emergency key.

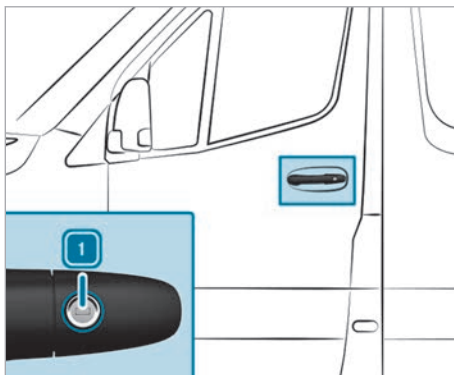

- ▶ **To unlock:** Turn the emergency key counter-clockwise to position 1.
- ▶ **To lock:** turn the emergency key clockwise to position 1.

- ❗ **Right-hand-drive vehicles:** turn the emergency key in the opposite direction for each case.

### Using the grab handles when getting into and out of the vehicle

The entrances may be equipped with grab handles and steps. The grab handles to enter and exit the vehicle are located at the front door and the sliding door.

- ❗ To avoid risks:
- Always use the grab handles and steps when getting into and out of the vehicle. These are specifically designed to withstand such loads.
  - Keep steps and entrances free from dirt, e.g. mud, clay, snow and ice.

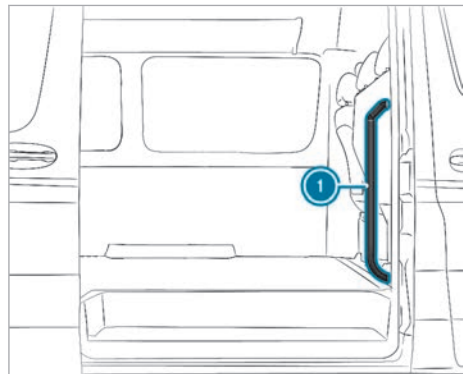

- ▶ When getting into and out of the vehicle, use the grab handles 1 and steps.

- ❗ The grab handles on the sliding door are provided as an easy entry and exit feature and can hold up to a maximum of 176 lbs (80 kg). Do not use the grab handle on the sliding door to secure a load (lashing). Do not secure any objects to the easy entry and exit features.

**Sliding door**

**Opening/closing the sliding door from the outside**

**⚠ WARNING** Risk of becoming trapped due to an open sliding door which is not engaged in place

On an incline, the sliding door can move by itself.

This can cause you or other people to become trapped.

- ▶ Always make sure that the open sliding door is engaged. To do so, open the sliding door to the stop.

**⚠ WARNING** Risk of becoming trapped due to sliding door opening towards the rear

When you open the sliding door, the sliding door could hit other people as it moves towards the rear of the vehicle.

- ▶ Only open the sliding door when traffic conditions permit.

**Requirements:**

- The vehicle is unlocked.

**To open**

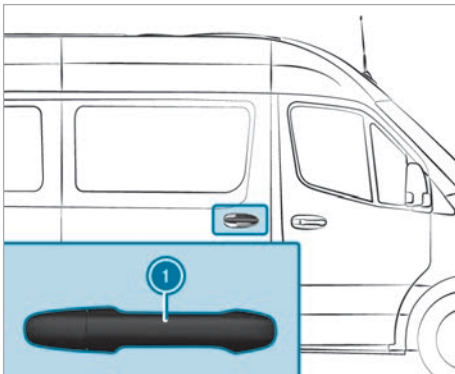

- ▶ Pull the door handle ①. The sliding door opens.
  - ▶ Push back the sliding door using the door handle ① until it engages.
  - ▶ Ensure that the sliding door is fully engaged by gently pulling on the door.
- ① If your vehicle features a long sliding door with intermediate locking, the sliding door can be locked in approximately the middle position.

This will allow you to access or exit the vehicle without having to always open the sliding door completely to its end position. The sliding door is not fully engaged when in the intermediate catch position.

**To close**

- ▶ Pull the door handle ①. The sliding door is released from its locking mechanism.
- ▶ Push the sliding door firmly forwards using the door handle ① and close.

**Opening/closing the sliding door from the inside**

**⚠ WARNING** Risk of becoming trapped due to an open sliding door which is not engaged in place

On an incline, the sliding door can move by itself.

This can cause you or other people to become trapped.

- ▶ Always make sure that the open sliding door is engaged. To do so, open the sliding door to the stop.

**⚠ WARNING** Risk of becoming trapped due to sliding door opening towards the rear

When you open the sliding door, the sliding door could hit other people as it moves towards the rear of the vehicle.

- ▶ Only open the sliding door when traffic conditions permit.

**To unlock**

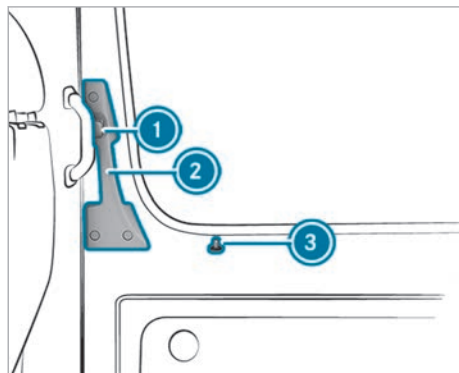

- ▶ Pull the safety pin ③ upwards manually or use the central locking button to unlock the sliding door (→ page 42).

#### To open

- ▶ **i** If your vehicle features a long sliding door with intermediate locking, the sliding door can be locked in approximately the middle position. This will allow you to access or exit the vehicle without having to always open the sliding door completely to its end position. The sliding door is not fully engaged when in the intermediate catch position.

- ▶ Press the button ①.
- ▶ Push back the sliding door using the door handle ② until it engages.
- ▶ Ensure that the sliding door is fully engaged by gently pulling on the door.

#### To close

- ▶ Press the button ①.  
The sliding door is released from its locking mechanism.
- ▶ Slide the sliding door firmly forwards using the door handle ② until it closes.

#### To lock

- ▶ Push the safety pin ③ downwards manually or use the central locking button to lock the sliding door (→ page 42).

#### Notes on electrical closing assist

If your vehicle is fitted with electrical closing assist, you will require less force to close the sliding door.

#### Electric sliding door

##### Function of the electric sliding door

Your vehicle may feature an electric sliding door on the right side.

You can open and close the sliding door with the following control elements:

- Sliding door button on the center console
- Sliding door button on the door sill (B-pillar)
- Door handle (inside or outside)
- Key

If the electric sliding door is obstructed while opening, it moves a few centimetres in the opposite direction and stops.

If the sliding door is obstructed while closing, it opens fully again.

If the electric motor of the sliding door is in danger of overheating, e.g. due to frequent opening and closing within a short period of time, the sliding door opens fully. The sliding door is then locked in place. The sliding door is operational again after approximately 30 seconds.

In the event of a malfunction or if the battery has been disconnected, you can use the unlocking mechanism to disconnect the sliding door from the electric motor. You can then open or close the sliding door manually (→ page 48).

#### Opening/closing the electric sliding door with the button

**⚠ WARNING** Risk of becoming trapped due to sliding door opening towards the rear

When you open the sliding door, the sliding door could hit other people as it moves towards the rear of the vehicle.

- ▶ Only open the sliding door when traffic conditions permit.

**⚠ WARNING** Risk of injury despite the object detection function

The object detection function does not react to soft, light and thin objects, such as fingers. The object detection function cannot prevent someone from becoming trapped in these situations.

- ▶ When opening and closing the electric sliding door, make sure that no parts of the body are within the operating range of the sliding door.
- ▶ If someone becomes trapped, press the button again to stop the sliding door.

#### Object recognition:

If an object obstructs the sliding door as it closes, the sliding door will be stopped. Object recognition is provided solely as an aid. It is not a substitute for you having to pay attention.

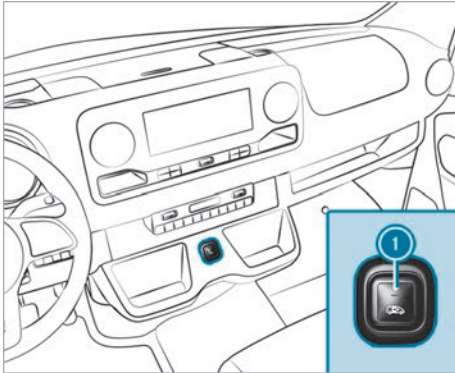

① Sliding door button for the right sliding door

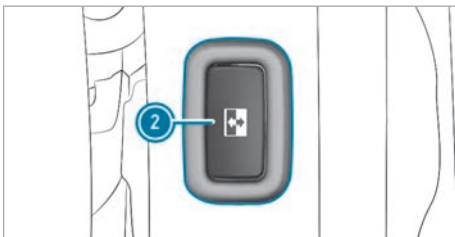

② Sliding door button on the door sill (B-pillar)

For vehicles with partition, the button ② is situated on the partition next to the door sill at the height of the door handle.

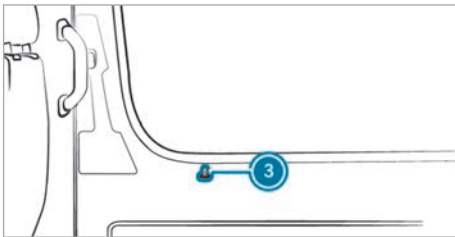

When the sliding door is locked, it can only be opened from the inside by manually unlocking the safety pin ③.

- ▶ **To unlock:** pull the safety pin ③ upwards manually or use the central locking button to unlock the sliding door (→ page 42).
- ▶ **To open:** press the buttons ① or ② briefly. The sliding door opens automatically. When opening with the button ①, two acoustic signals are also sounded.

The indicator lamp in the button ① flashes and the button ② flashes.

If the sliding door is opened completely, the indicator lamp in the button ① lights up.

- ▶ **To close:** press the buttons ① or ② briefly. The sliding door closes automatically.

When closing with the button ①, two acoustic signals are also sounded.

The indicator lamp in the button ① flashes and the button ② flashes.

If the sliding door is closed completely, the indicator lamp in the button ① goes out.



- ▶ **To stop automatic operation:** press the button ① briefly. The sliding door stops.

- ▶ **To lock:** push the safety pin ③ downwards manually or use the central locking button to lock the sliding door (→ page 42).

① When you stop automatic operation during opening of the door, the door closes when you press the button again.

① In less favourable operating conditions, e.g. frost or ice, or if the vehicle is very dirty, you can press and hold the corresponding button. The electric sliding door moves with increased force. Please note that the object recognition function will then be less sensitive. To stop the movement, release the button.

### Opening and closing the electric sliding door with the key

- ▶ **To unlock:** press the button  on the key briefly.
- ▶ **To open/close:** hold the button  on the key pressed for longer than 0.5 seconds. Two acoustic signals are sounded and the sliding door opens or closes automatically.
- ▶ **To interrupt automatic operation:** press the button  on the key briefly. The sliding door stops.

① If automatic operation is interrupted during the opening process, the door closes if the button is pressed again.

### Opening/closing the electric sliding door using the door handle

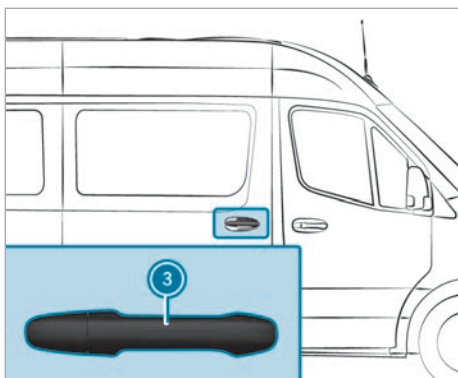
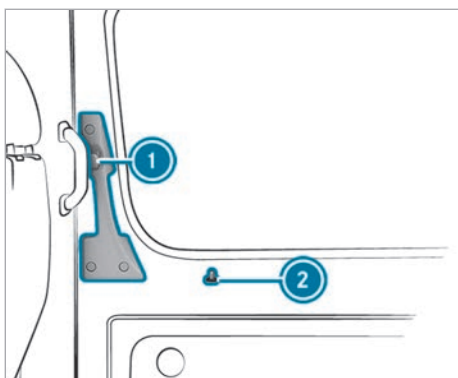

- ▶ **To unlock:** pull the safety pin ② upwards manually or use the central locking button to unlock the sliding door (→ page 42).
- ▶ **To open/close:** press the button ① or pull on the door handle ③.  
The sliding door opens or closes.
- ▶ **To interrupt automatic operation:** press the button ① again or pull on the door handle ③.  
The sliding door stops.

### Unlocking the electric sliding door manually

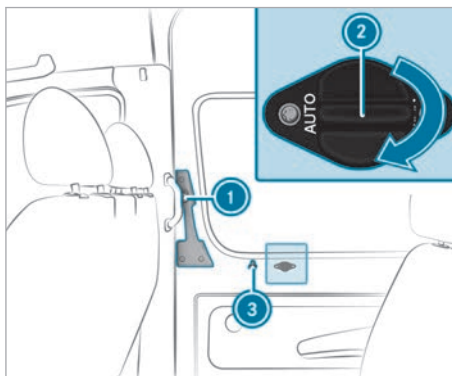

In the event of a malfunction or if the battery has been disconnected, you can use the battery disconnect switch ② to disconnect the sliding door from the electric motor. You can then open or close the sliding door manually.

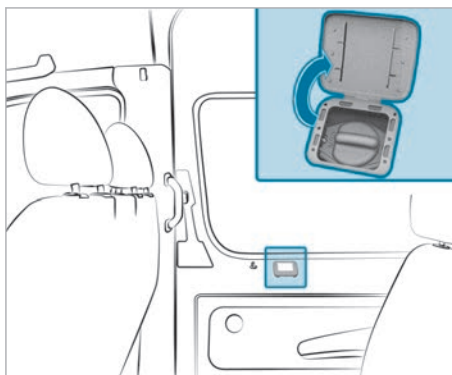

Cover in sliding door trim

- ▶ **Vehicles with sliding door trim:** lift up the cover of the battery disconnect switch ②.  
The battery disconnect switch is now accessible.
- ▶ **To disconnect the sliding door from the electric motor:** turn the battery disconnect switch ② 180° clockwise.  
The "MAN" position is set.

#### To unlock

- ▶ Pull the safety pin ③ upwards manually or use the central locking button to unlock the sliding door (→ page 42).
- ▶ Press the release knob ①.

- ▶ Open or close the sliding door with the outside or inside door handle.

### Establishing the connection between sliding door and electric motor

- ▶ Turn the battery disconnect switch ② 180° counter-clockwise.  
The "AUTO" position is set.
- ▶ Adjust the sliding door (→ page 49).
- ▶ If it is not possible to rectify the malfunction, consult a qualified specialist workshop.

### Resetting the electric sliding door

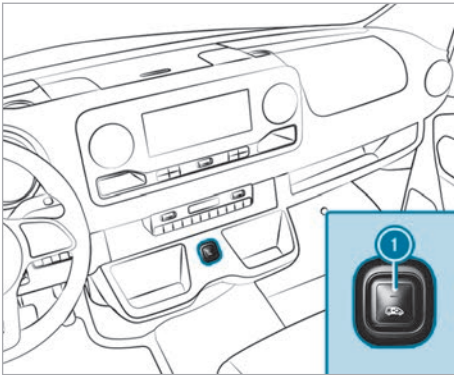

Sliding door button on the center console

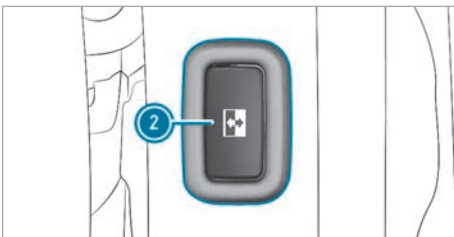

Sliding door button on the door sill (B-pillar)

You must reset the sliding door in the event of a malfunction or voltage drop.

- ▶ If the sliding door is open: Hold the ① button on the center console or the sliding door button ② on the door sill (B-pillar) pressed until the door closes.

or

- ▶ Close the sliding door using the door handle (→ page 48).

- ▶ Then briefly press the ① button on the center console or the sliding door button ② on the door sill (B-pillar) once or pull the door handle (→ page 48) to open the sliding door completely.  
The sliding door is operational.

### Rear-end doors

#### Opening/closing the rear-end doors from the outside

- ▲ **WARNING** Danger of accidents due to concealed lighting systems

If you open the rear doors by 90°, the rear lighting systems are concealed.

other road users cannot see the vehicle or can see it only with difficulty

- ▶ Therefore, in these or similar cases, secure the vehicle in accordance with national regulations, e.g. with the warning triangle.

- ▲ **WARNING** Risk of injury due to the rear-end door swinging open

When you open a rear-end door, the following can occur:

- You or another person can be injured.
- A person may be struck by oncoming traffic.

This is particularly the case if you open the rear-end door more than 90° or if it opens in an uncontrolled manner.

Even rear-end doors which are properly closed can swing open when the vehicle parked is on an incline or it is windy.

- ▶ Only open a rear-end door when the traffic conditions and surroundings permit.
- ▶ Always make sure that the rear-end doors are properly closed.

- **NOTE** Damage to the rear-end doors due to objects obstructing their range of movement

When the rear-end doors are opened, any objects obstructing the range of movement of the rear-end doors can be damaged as well as the vehicle.

- ▶ Make sure that there is sufficient clearance when opening the rear-end doors.

### Opening the right rear-end door

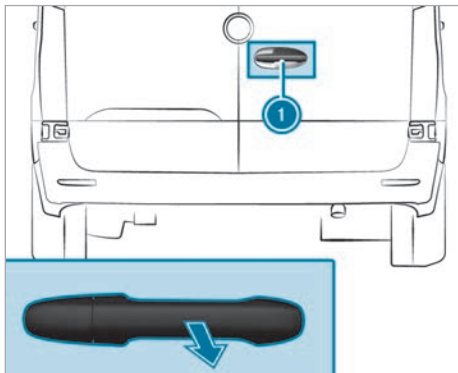

Depending on the respective version of vehicle, the rear-end doors can be locked at an angle of approximately 90° and 270° (side wall).

- ▶ Pull the door handle ①.
  - ▶ Swing the rear-end door to the side until it engages at approximately 90° or 270°.
- ① Depending on the respective version of vehicle, the rear-end doors can be opened beyond 90°, even with door check (→ page 50).

### Opening the left rear-end door



- ▶ Ensure that the right rear-end door is open and engaged.
- ▶ Pull the release handle ① in the direction indicated by the arrow.
- ▶ Swing the rear-end door to the side until it engages at approximately 90° or 270°.

### Closing the rear-end doors from the outside

- ▶ Close the left rear-end door firmly from the outside.
- ▶ Close the right rear-end door firmly from the outside.

### Opening the rear-end doors with door check beyond 90°

**⚠ WARNING** Risk of injury due to the rear-end door swinging open

When you open a rear-end door, the following can occur:

- You or another person can be injured.
- A person may be struck by oncoming traffic.

This is particularly the case if you open the rear-end door more than 90° or if it opens in an uncontrolled manner.

Even rear-end doors which are properly closed can swing open when the vehicle parked is on an incline or it is windy.

- ▶ Only open a rear-end door when the traffic conditions and surroundings permit.
- ▶ Always make sure that the rear-end doors are properly closed.

**! NOTE** Damage to the rear-end doors due to objects obstructing their range of movement

When the rear-end doors are opened, any objects obstructing the range of movement of the rear-end doors can be damaged as well as the vehicle.

- ▶ Make sure that there is sufficient clearance when opening the rear-end doors.

**Requirements:**

- The vehicle features the necessary equipment for opening the rear-end doors up to an angle of 270° (side wall).

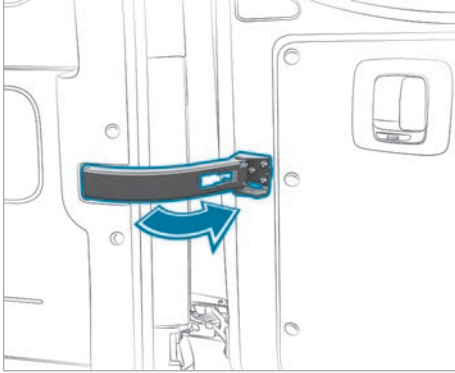

- ▶ Open the rear-end door to approximately 45°.
- ▶ Pull the door check in the direction of the arrow and hold in place.
- ▶ Open the rear-end door beyond 90° so that the door check can no longer lock in place.
- ▶ Release the door check and open the rear-end door until it engages at approximately 270°.

### Opening/closing the rear-end doors from the inside

**⚠ WARNING** Risk of injury due to the rear-end door swinging open

When you open a rear-end door, the following can occur:

- You or another person can be injured.
- A person may be struck by oncoming traffic.

This is particularly the case if you open the rear-end door more than 90° or if it opens in an uncontrolled manner.

Even rear-end doors which are properly closed can swing open when the vehicle parked is on an incline or it is windy.

- ▶ Only open a rear-end door when the traffic conditions and surroundings permit.
- ▶ Always make sure that the rear-end doors are properly closed.



**❗ NOTE** Damage to the rear-end doors due to objects obstructing their range of movement

When the rear-end doors are opened, any objects obstructing the range of movement of the rear-end doors can be damaged as well as the vehicle.

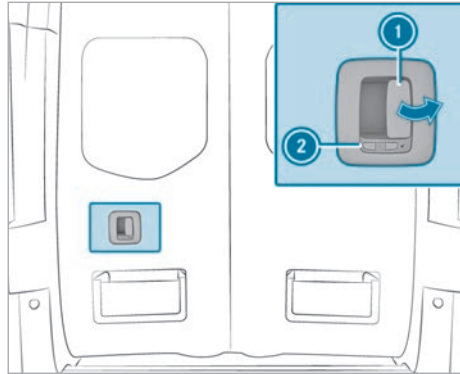
- ▶ Make sure that there is sufficient clearance when opening the rear-end doors.



The  symbol indicates that the rear-end door is unlocked.

- ▶ **To unlock:** slide the catch **②** to the left. The  symbol is visible.
- ▶ **To open:** Pull the opening lever **①** and open the rear-end door. Swing the rear-end door to the side until it engages.
- ▶ **To close:** Ensure that the left rear-end door is closed. Pull the right rear-end door firmly shut using the door handle.
- ▶ **To lock:** slide the catch **②** to the right. The  symbol is visible.

### Partition sliding door

#### Opening and closing the partition sliding door

**⚠ WARNING** Risk of becoming trapped if the partition sliding door is not engaged

The partition sliding door may move on its own while the vehicle is in motion.

This can cause you or other people to become trapped.

- ▶ Before every journey, close the partition sliding door and ensure that it is engaged.

#### From the cab

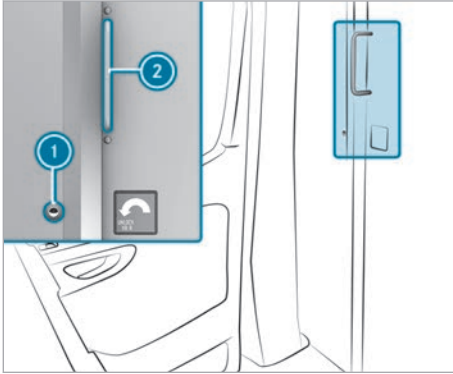

- ▶ **To lock and unlock with a separate key:** turn lock cylinder ① to the right to lock or to the left to unlock.
- ▶ **To open:** using door handle ②, push the sliding door all the way to the right.
- ▶ **To close:** using door handle ②, push the sliding door to the left until it engages.

#### From the cargo compartment

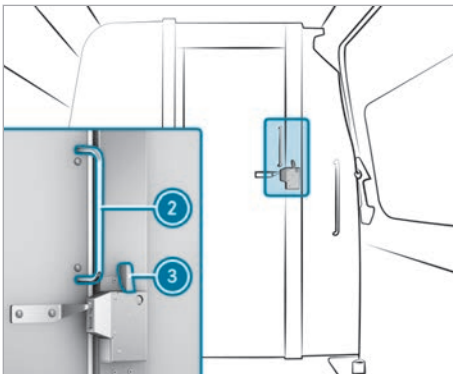

- ▶ **To lock and unlock:** push lever ③ to the left to lock or to the right to unlock.
- ▶ **To open:** using door handle ②, push the sliding door all the way to the left.
- ▶ **To close:** using door handle ②, push the sliding door to the right until it engages.

### Side window

#### Opening and closing the side windows

- ⚠ **WARNING** Risk of entrapment when opening a side window

When opening a side window, parts of the body could be drawn in or become trapped between the side window and window frame.

- ▶ When opening, make sure that nobody is touching the side window.
- ▶ If someone is trapped, release the button immediately or pull it in order to close the side window again.

- ⚠ **WARNING** Risk of becoming trapped when closing a side window

When closing a side window, body parts could be trapped in the closing area in the process.

- ▶ When closing, make sure that no body parts are in the closing area.
- ▶ If someone is trapped, release the button immediately or press the button in order to reopen the side window.

- ⚠ **WARNING** Risk of becoming trapped when children operate the side windows

Children could become trapped if they operate the side windows, particularly when unattended.

- ▶ Activate the child safety lock for the rear passenger compartment side windows.
- ▶ When leaving the vehicle, always take the SmartKey with you and lock the vehicle.
- ▶ Never leave children unattended in the vehicle.

- ⚠ **WARNING** Risk of fatal injury due to exposure to extreme heat or cold in the vehicle

If persons, particularly children, are subjected to prolonged exposure to intense heat or cold, there is a risk of severe injury or even death.

- ▶ Never leave persons, particularly children, unattended in the vehicle.

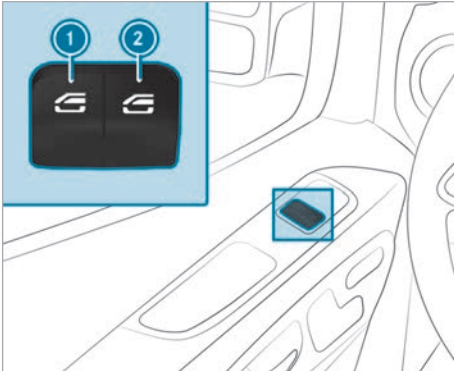

- ▶ **To open manually:** press and hold button ① or ②.
- ▶ **To close manually:** pull and hold button ① or ②.

The windows in the front doors can also be operated automatically.

- ▶ **To open completely:** briefly press button ① or ② beyond the point of resistance. Automatic operation will start.
- ▶ **To close completely:** briefly pull button ① or ② beyond the point of resistance. Automatic operation will start.
- ▶ **To interrupt automatic operation:** briefly press or pull button ① or ② again.

#### Automatic reversing function of the side windows

If an object blocks a side window during the closing process, the side window will open again automatically. The automatic reversing function is only an aid and is not a substitute for your attentiveness.

- ① If automatic operation of the side window does not work, there will also be no automatic reversing function.
- ▶ During the closing process, make sure that no body parts are in the closing area.

**⚠ WARNING** Risk of becoming trapped despite there being reversing protection on the side window

The reversing function will not react:

- to soft, light and thin objects, e.g. fingers
- over the last 1/8 in (4 mm) of the closing path

- during resetting
- when the side window is closed again manually immediately after automatic reversing

The reversing function cannot prevent someone from becoming trapped in these situations.

- ▶ During the closing process, make sure that no body parts are in the closing area.
- ▶ If someone becomes trapped, press the  button to open the side window again.

#### Ventilating the vehicle before starting a journey (convenience opening)



**⚠ WARNING** Risk of entrapment when opening a side window

When opening a side window, parts of the body could be drawn in or become trapped between the side window and window frame.

- ▶ When opening, make sure that nobody is touching the side window.
- ▶ Release the button immediately if somebody becomes trapped.

You can ventilate the vehicle before you begin driving.

The "convenience opening" function can be operated using the key without switching on the vehicle. The key must be in close proximity to the driver's door or front passenger door.



- ▶ Press and hold the button  on the key. The following functions are performed:
  - the vehicle is unlocked
  - the side windows are opened
- ▶ **To interrupt convenience opening:** release the button .

#### Closing the side windows from the outside (convenience closing)

**⚠ WARNING** Risk of entrapment due to not paying attention during convenience closing

When the convenience closing feature is operating, parts of the body could become trapped in the closing area of the side windows.

- ▶ When the convenience closing feature is operating, monitor the entire closing process and make sure that no body parts are in the closing area.

- ▶ Press and hold the button  on the key. The following functions are performed:
  - the vehicle is locked
  - the side windows are closed
- ▶ **To interrupt convenience closing:** release the button .

### Resetting the side windows

The side windows must be readjusted after a malfunction or a voltage supply interruption.

- ▶ Switch on the power supply (→ page 96).
- ▶ Push both buttons on the power window and hold for approximately one second after the side window has closed.

### Rectifying problems with the side windows

**⚠ WARNING** Risk of becoming trapped or fatally injured if reversing protection is not activated

If you close a side window again immediately after it has been blocked, the side window will close with increased or maximum force. The reversing function is then not active and body parts may become trapped.

- ▶ Make sure that no parts of the body are in the closing area.
- ▶ To stop the closing process, release the button or press the button again to reopen the side window.

**You cannot open or close a side window all the way.**

- ▶ Check to see if there are any objects in the window guide.
- ▶ Reset the side windows (→ page 54).

**The side windows cannot be opened or closed with the vehicle key**

Possible cause:

- The key battery is weak or flat.
- ▶ Check the key battery using the indicator lamp and replace it if necessary (→ page 40).

## Anti-theft protection

### Function of the immobilizer

The immobilizer prevents your vehicle from being started without the correct key.

The immobilizer will automatically be activated when the vehicle is switched off and deactivated when the vehicle is switched on.

When leaving the vehicle, always take the key with you and lock the vehicle. If the key is left inside the vehicle, anyone can start the vehicle.

- ⓘ If you cannot start the drive system with the 12 V on-board electrical system battery fully charged, the immobilizer may be faulty. Contact a qualified specialist workshop or call 1-800-367-6372 (in the USA) or 1-800-387-0100 (in Canada).

### ATA (Anti-Theft Alarm system)

#### Function of ATA (Anti-Theft Alarm system)

If the ATA system is armed, a visual and audible alarm is triggered in the following situations:

- A side door is opened
- The rear-end door is opened
- The hood is opened
- The interior protection is triggered (→ page 56)
- Tow-away protection is triggered (→ page 55)

The alarm will not be deactivated, even if the door which was opened to trigger the alarm is immediately closed again, for example.

Canceling a triggered alarm (→ page 55).

The ATA is activated automatically after approximately ten seconds in the following instance:

- after the vehicle has been locked with the key

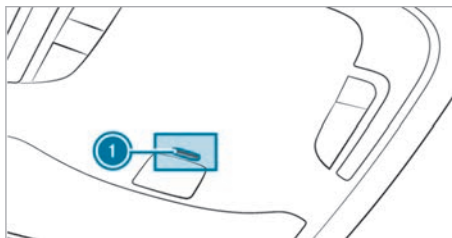

When the ATA system is armed, an indicator lamp **1** flashes in the overhead control panel.

ATA is automatically deactivated in the following situations:

- after unlocking the vehicle with the key
- after pressing the start/stop button with the key inside the vehicle

### Arming/disarming the ATA (Anti-Theft Alarm system)

#### To activate

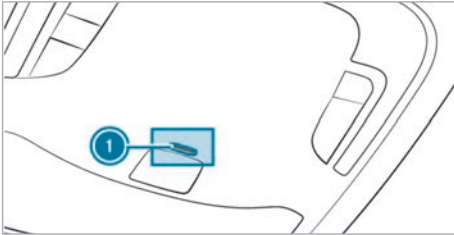



- ▶ Close all doors.
- ⓘ Close the side window or deactivate the interior protection (→ page 56) to prevent a false alarm.
- ▶ Lock the vehicle with the key.  
The indicator lamp ① in the overhead control panel begins flashing.

#### To deactivate

- ▶ Unlock the vehicle with the key.  
The indicator lamp ① in the overhead control panel goes out.
- ⓘ The vehicle locks again automatically if you do not open a door within 40 seconds after unlocking the vehicle.

#### Canceling the alarm

- ▶ Press the buttons  or  on the key.
- or
- ▶ Press the start/stop button with the key inside the vehicle.  
The alarm is switched off.

### Function of the tow-away alarm

When the tow-away alarm is armed, a visual and audible alarm is triggered if the vehicle's inclination changes. This may be the case, for example, if the vehicle is lifted on one side.

### Arming/disarming the tow-away alarm

#### Arming/disarming

- ▶ Lock the vehicle with the key.  
The tow-away alarm will automatically be armed after about 40 seconds:
- ▶ Open the vehicle with the key.  
The tow-away alarm will be disarmed.

The tow-away alarm will be armed if the following condition is met:

- All the doors are closed.

#### Deactivating

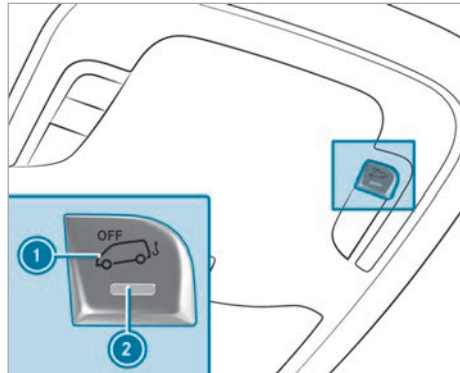

- ▶ Switch off the vehicle (→ page 96).
- ▶ Press button ①.  
When the button is released, indicator lamp ② on the button will light up for approximately three seconds.
- ▶ Lock the vehicle with the key.  
The tow-away alarm will be disarmed.

The tow-away alarm will be armed again in the following cases:

- The vehicle is unlocked again.
- A door is opened.
- The vehicle is locked again.

Disarm the tow-away alarm when locking your vehicle in the following situations:

- when loading and/or transporting the vehicle on a ferry or car transporter, for example
- when parking the vehicle on a movable surface, such as a split-level garage

False alarms will thus be prevented.

### Function of interior protection

#### Function

A visual and acoustic alarm is triggered if the armed interior protection detects motion in the vehicle interior.

### Arming/deactivating the interior protection

#### Arming

- ▶ Close the side windows.
- ▶ Ensure that no objects (such as mascots or clothes hangers) are hanging on the inside mirror or on the grab handles. False alarms will thus be prevented.
- ▶ Lock the vehicle with the key.  
The interior protection is armed after approximately 40 seconds.

The interior protection is activated if the following condition is met:

- All the doors are closed.

#### Switching off

- ▶ Unlock the vehicle with the key.  
The interior protection automatically switches off.

#### Deactivating

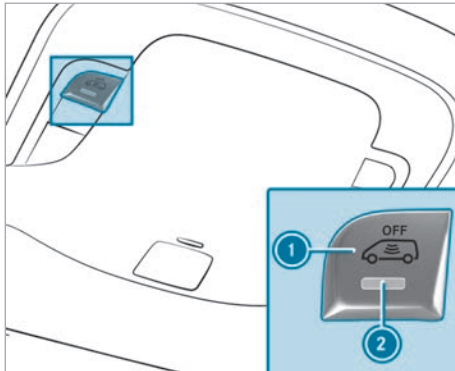

- ▶ Switch off the vehicle (→ page 96).
- ▶ Press the ① button.  
When the button is released, indicator lamp ② in the button lights up for approximately three seconds.
- ▶ Lock the vehicle with the key.  
The interior protection is deactivated.

The interior protection is activated again in the following instances:

- the vehicle is unlocked again.
- a door is opened
- the vehicle is locked again.

Deactivate the interior protection when locking your vehicle in the following situations:

- people or animals remain inside the vehicle
- if the side windows remain open
- when transporting the vehicle, for example on a ferry or car transporter.

False alarms will thus be prevented.

### Notes on the correct driver's seat position

**▲ WARNING** Risk of accident due to adjusting the vehicle settings while the vehicle is in motion

You could lose control of the vehicle in the following situations in particular:

- If you adjust the driver's seat, the head restraint, the steering wheel or the mirror while the vehicle is in motion
  - If you fasten your seat belt while the vehicle is in motion
- ▶ Before starting the vehicle: in particular, adjust the driver's seat, head restraint, steering wheel and mirror, and fasten your seat belt.

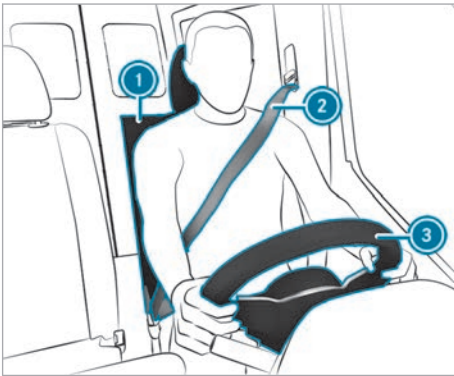

Ensure the following when adjusting steering wheel ③, seat belt ② or driver's seat ①:

- You are sitting as far away from the driver's air bag as possible.
- You are sitting in an upright position.
- Your thighs are gently supported by the seat cushion.
- Your legs are not fully extended and you can reach the pedals easily.
- The back of your head is supported at eye level by the middle part of the head restraint.
- You can hold the steering wheel with your arms slightly bent.
- You can move your legs without any restrictions.
- You can see all of the instrument cluster displays well.

- You have a good overview of the traffic conditions.
- Your seat belt sits snugly against your body and passes across the center of your shoulder and across your hips in the pelvic area.

### Notes on grab handles

**▲ WARNING** Risk of injury due to excessive load on the grab handles

If you apply your full body weight to the grab handle or pull it abruptly, the grab handle may be damaged or come loose from its anchorage. This may result in injuries.

- ▶ Use the grab handles only to stabilize the seating position or to assist in getting in and out of the seat.

### Seats

#### Adjusting the front seats manually (without Seat Comfort Package)

**▲ WARNING** Risk of becoming trapped if the seat is adjusted by children

Children could become trapped if they adjust the seats, particularly if they are unattended.

- ▶ When leaving the vehicle, always take the key with you and lock the vehicle.
- ▶ Never leave children unattended in the vehicle.

**▲ WARNING** Risk of becoming trapped if the seats are adjusted

When adjusting a seat, you may trap yourself or a vehicle occupant, e.g. on the seat guide rail.

- ▶ Make sure that no part of the body is within the seat's range of motion when adjusting a seat.

Observe the safety notes on "Air bags" and "Children in the vehicle".

**▲ WARNING** Risk of accident due to the driver's seat not being engaged

The driver's seat may move unexpectedly while driving.

This could cause you to lose control of the vehicle.

- ▶ Always make sure that the driver's seat is engaged before starting the vehicle.

**⚠ WARNING** Risk of accident due to adjusting the vehicle settings while the vehicle is in motion

You could lose control of the vehicle in the following situations in particular:

- If you adjust the driver's seat, the head restraint, the steering wheel or the mirror while the vehicle is in motion
  - If you fasten your seat belt while the vehicle is in motion
- ▶ Before starting the vehicle: in particular, adjust the driver's seat, head restraint, steering wheel and mirror, and fasten your seat belt.

**⚠ WARNING** Risk of becoming trapped if you do not take care while adjusting the seat height

If you do not take care while adjusting the seat height, you or other vehicle occupants could become trapped and suffer injury as a result.

In particular, children could inadvertently actuate the seat adjustment system and become trapped as a result.

- ▶ Make sure that no hands or other parts of the body get under the seat adjustment system levers while the seat is being moved.

**⚠ WARNING** Risk of injury due to head restraints not being installed or being adjusted incorrectly

If head restraints have not been installed or have not been adjusted correctly, there is an increased risk of injury in the head and neck area, e.g. in the event of an accident or when braking.

- ▶ Always drive with the head restraints installed.
- ▶ Before driving off, make sure for every vehicle occupant that the center of the head restraint supports the back of the head at about eye level.

Using the head restraint fore-and-aft adjustment, adjust the head restraint so that it is as close to the back of your head as possible.

**⚠ WARNING** Risk of injury or death due to an incorrect seat position

The seat belt does not offer the intended level of protection if you have not moved the seat backrest to an almost vertical position.

In particular, you could slip beneath the seat-belt and become injured.

- ▶ Adjust the seat properly before beginning your journey.
- ▶ Always ensure that the seat backrest is in an almost vertical position and that the shoulder belt is routed across the center of your shoulder.

**! NOTE** Damage to the seats when moving the seats back

The seats may be damaged by objects when moving the seats back.

- ▶ When moving the seats back, make sure that there are no objects in the footwell, under or behind the seats.

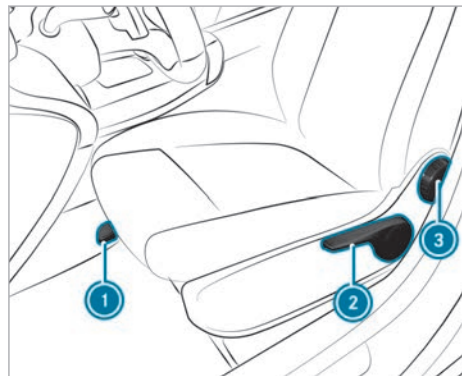

- ① Seat fore-and-aft position
- ② Seat height
- ③ Seat backrest inclination

▶ **To adjust the seat fore-and-aft position:** lift lever ① and slide the seat into the desired position. Ensure that the seat is engaged.

▶ **To adjust the seat height:** keep on pressing or pulling lever ② until the required seat height has been reached.

- ▶ **To adjust the seat backrest inclination:** rotate handwheel ③ forwards and backwards until the desired position has been reached.

### Adjusting the front seats manually (with Seat Comfort Package)

- ⚠ **WARNING** Risk of becoming trapped if the seat is adjusted by children

Children could become trapped if they adjust the seats, particularly if they are unattended.

- ▶ When leaving the vehicle, always take the key with you and lock the vehicle.
- ▶ Never leave children unattended in the vehicle.

- ⚠ **WARNING** Risk of becoming trapped if the seats are adjusted

When adjusting a seat, you may trap yourself or a vehicle occupant, e.g. on the seat guide rail.

- ▶ Make sure that no part of the body is within the seat's range of motion when adjusting a seat.

Observe the safety notes on "Air bags" and "Children in the vehicle".

- ⚠ **WARNING** Risk of accident due to the driver's seat not being engaged

The driver's seat may move unexpectedly while driving.

This could cause you to lose control of the vehicle.

- ▶ Always make sure that the driver's seat is engaged before starting the vehicle.

- ⚠ **WARNING** Risk of accident due to adjusting the vehicle settings while the vehicle is in motion

You could lose control of the vehicle in the following situations in particular:

- If you adjust the driver's seat, the head restraint, the steering wheel or the mirror while the vehicle is in motion
- If you fasten your seat belt while the vehicle is in motion
- ▶ Before starting the vehicle: in particular, adjust the driver's seat, head restraint,

steering wheel and mirror, and fasten your seat belt.

- ⚠ **WARNING** Risk of becoming trapped if the seat height is adjusted carelessly

If you adjust the seat height carelessly, you or other vehicle occupants could be trapped and thereby injured.

Children in particular could accidentally press the electrical seat adjustment buttons and become trapped.

- ▶ While moving the seats, make sure that hands or other body parts do not get under the lever assembly of the seat adjustment system.

- ⚠ **WARNING** Risk of injury due to head restraints not being installed or being adjusted incorrectly

If head restraints have not been installed or have not been adjusted correctly, there is an increased risk of injury in the head and neck area, e.g. in the event of an accident or when braking.

- ▶ Always drive with the head restraints installed.
- ▶ Before driving off, make sure for every vehicle occupant that the center of the head restraint supports the back of the head at about eye level.

Using the head restraint fore-and-aft adjustment, adjust the head restraint so that it is as close to the back of your head as possible.

- ⚠ **WARNING** Risk of injury or death due to an incorrect seat position

The seat belt does not offer the intended level of protection if you have not moved the seat backrest to an almost vertical position.

In particular, you could slip beneath the seat-belt and become injured.

- ▶ Adjust the seat properly before beginning your journey.
- ▶ Always ensure that the seat backrest is in an almost vertical position and that the shoulder belt is routed across the center of your shoulder.

- I NOTE** Damage to the seats when moving the seats back

The seats may be damaged by objects when moving the seats back.

- ▶ When moving the seats back, make sure that there are no objects in the footwell, under or behind the seats.

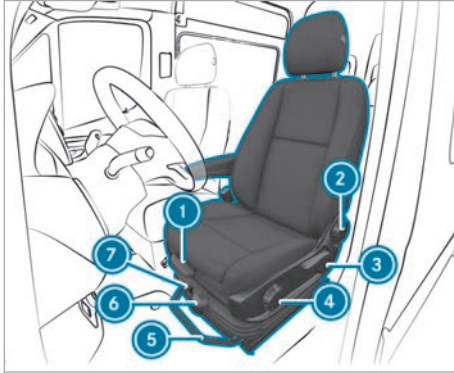

Example image of comfort suspension seat

- ① Seat cushion length
  - ② Seat backrest inclination
  - ③ Seat height
  - ④ Seat cushion inclination
  - ⑤ Seat fore-and-aft position
  - ⑥ Seat suspension
  - ⑦ Vibration limiting
- ▶ **To adjust the seat cushion length:** lift lever ① and slide the front part of the seat cushion forwards or backwards.
  - ▶ **To adjust the seat backrest inclination:** rotate handwheel ② forwards and backwards until the desired position has been reached.
  - ▶ **To adjust the seat height:** pull or push lever ③ until the desired position has been reached.
  - ▶ **To adjust the seat cushion inclination:** rotate handwheel ④ forwards and backwards until the desired position has been reached.
  - ▶ **To adjust the seat fore-and-aft position:** lift lever ⑤ and slide the seat into the desired position.
  - ▶ **To check for safety:** ensure that the seat is engaged.
  - ▶ **To adjust the seat suspension:** take your weight off the seat.

- ▶ Using handwheel ⑥, set the body weight (88 lb (40 kg) to 265 lb (120 kg)) so that the seat suspension works optimally. If you set a higher weight, the seat suspension will become firmer. The seat will then not vibrate as much. If the seat vibrates often and significantly, you can engage it in the lower area.
- ▶ **To engage vibration limiting:** turn lever ⑦ upwards.  
The next time the seat vibrates, it will engage.
- ▶ **To release vibration limiting:** turn lever ⑦ to the right.  
The seat will then be able to vibrate.

### Adjusting the front seat electrically

- ⚠ WARNING** Risk of becoming trapped if the seat is adjusted by children

Children could become trapped if they adjust the seats, particularly if they are unattended.

- ▶ When leaving the vehicle, always take the key with you and lock the vehicle.
- ▶ Never leave children unattended in the vehicle.

The seats can be adjusted when the vehicle is switched off.

- ⚠ WARNING** Risk of becoming trapped if the seats are adjusted

When adjusting a seat, you may trap yourself or a vehicle occupant, e.g. on the seat guide rail.

- ▶ Make sure that no part of the body is within the seat's range of motion when adjusting a seat.

Observe the safety notes on "Air bags" and "Children in the vehicle".

- ⚠ WARNING** Risk of accident due to the driver's seat not being engaged

The driver's seat may move unexpectedly while driving.

This could cause you to lose control of the vehicle.

- ▶ Always make sure that the driver's seat is engaged before starting the vehicle.

**⚠ WARNING** Risk of accident due to adjusting the vehicle settings while the vehicle is in motion

You could lose control of the vehicle in the following situations in particular:

- If you adjust the driver's seat, the head restraint, the steering wheel or the mirror while the vehicle is in motion
  - If you fasten your seat belt while the vehicle is in motion
- ▶ Before starting the vehicle: in particular, adjust the driver's seat, head restraint, steering wheel and mirror, and fasten your seat belt.

**⚠ WARNING** Risk of becoming trapped if the seat height is adjusted carelessly

If you adjust the seat height carelessly, you or other vehicle occupants could be trapped and thereby injured.

Children in particular could accidentally press the electrical seat adjustment buttons and become trapped.

- ▶ While moving the seats, make sure that hands or other body parts do not get under the lever assembly of the seat adjustment system.

**⚠ WARNING** Risk of injury due to head restraints not being installed or being adjusted incorrectly

If head restraints have not been installed or have not been adjusted correctly, there is an increased risk of injury in the head and neck area, e.g. in the event of an accident or when braking.

- ▶ Always drive with the head restraints installed.
- ▶ Before driving off, make sure for every vehicle occupant that the center of the head restraint supports the back of the head at about eye level.

Do not rotate the head restraints of the front seats. Otherwise, you will not be able to set the height and inclination of the head restraints to the correct position.

Using the head restraint fore-and-aft adjustment, adjust the head restraint so that it is as close to the back of your head as possible.

**⚠ WARNING** Risk of injury or death due to an incorrect seat position

The seat belt does not offer the intended level of protection if you have not moved the seat backrest to an almost vertical position.

In particular, you could slip beneath the seat-belt and become injured.

- ▶ Adjust the seat properly before beginning your journey.
- ▶ Always ensure that the seat backrest is in an almost vertical position and that the shoulder belt is routed across the center of your shoulder.

**❗ NOTE** Damage to the seats when moving the seats back

The seats may be damaged by objects when moving the seats back.

- ▶ When moving the seats back, make sure that there are no objects in the footwell, under or behind the seats.

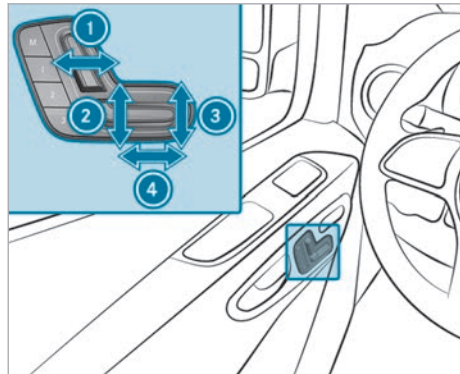

- ① Seat backrest inclination
- ② Seat height
- ③ Seat cushion inclination
- ④ Seat fore-and-aft position

- ▶ Save the settings with the memory function (→ page 62).

### Setting 4-way lumbar support

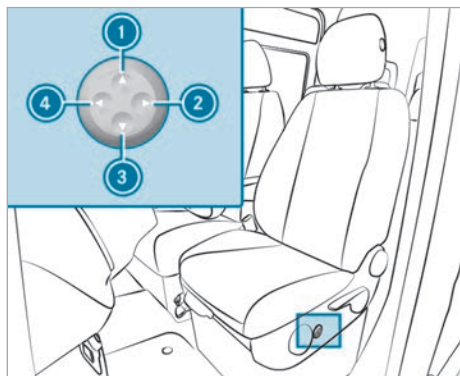

- ① Higher
- ② Softer
- ③ Lower
- ④ Firmer

▶ Use buttons ① to ④ adjust the backrest contour individually to your spine.

### Operating the memory function

**⚠ WARNING** Risk of an accident if the memory function is used while driving

If you use the memory function on the driver's side while driving, you could lose control of the vehicle as a result of the adjustments being made.

▶ Only use the memory function on the driver's side when the vehicle is stationary.

**⚠ WARNING** Risk of entrapment when adjusting the seat with the memory function

When the memory function adjusts the seat, you and other vehicle occupants – particularly children – could become trapped.

▶ During the adjustment process of the memory function, make sure that no one has any body parts in the sweep of the seat.

▶ If somebody becomes trapped, immediately release the memory function position button.  
The adjustment process is stopped.

**⚠ WARNING** Danger of entrapment when memory function is activated by children

When children activate the memory function, they can get trapped, especially if they are unsupervised.

- ▶ Never leave children unattended in the vehicle.
- ▶ When leaving the vehicle, always take the key with you and lock the vehicle.

The memory function can be used when the vehicle is switched off.

### Storing seat adjustments

Seat adjustments for up to three people can be stored and called up using the memory function. You can adjust the seat and the backrest.

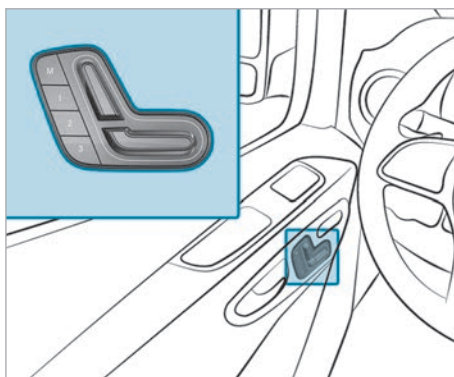

- ▶ Adjust the seat to the desired position.
- ▶ Press memory button M together with one of preset position buttons 1, 2 or 3. An acoustic signal will sound. The settings are stored.
- ▶ **To call up:** press and hold preset position button 1, 2 or 3 until the front seat is in the stored position.

### Rotating the front seats

**⚠ WARNING** Risk of injury or fatal injuries if the driver's seat and front passenger seat are not engaged

In this situation, the restraint systems cannot perform their intended protective function.

- ▶ Engage the driver's seat and front passenger seat in the direction of travel before you start the vehicle.

**⚠ WARNING** Risk of accident due to adjusting the vehicle settings while the vehicle is in motion

You could lose control of the vehicle in the following situations in particular:

- If you adjust the driver's seat, the head restraint, the steering wheel or the mirror while the vehicle is in motion
  - If you fasten your seat belt while the vehicle is in motion
- ▶ Before starting the vehicle: in particular, adjust the driver's seat, head restraint, steering wheel and mirror, and fasten your seat belt.

**⚠ WARNING** Risk of injury when the seat is pushed backwards

If the seat has been pushed backwards, you may injure yourself on the seat guide rails protruding at the front.

- ▶ Make sure that you do not touch the seat guide rails.



You can rotate the driver's and front passenger seats by 50° and 180°. The seats engage both in and opposite to the direction of travel as well as at 50° towards the exit.

- ▶ Ensure that the parking brake is applied and the brake lever (if applicable) is down as far as it will go (→ page 118).

- ▶ When rotating the seat, open the respective front door in order to avoid a collision with the door trim.
- ▶ Adjust the steering wheel in such a way that there is sufficient clearance to rotate and adjust the driver's seat (→ page 66).
- ▶ Slide the front passenger seat forward before rotating it (→ page 57).
- ▶ **To rotate the seat:** push lever ① towards the door and rotate the seat slightly inwards. The turning device will be unlocked.
- ▶ Release lever ① again.
- ▶ Rotate the seat outwards or inwards into the required position.

### Folding the co-driver bench seat cushion forwards and backwards



- ▶ **To fold the seat surface forward:** lift seat surface out of front anchorage ①.
- ▶ Pull the seat surface out of rear anchorage ② and move it slightly forwards.
- ▶ Fold the rear edge of the seat surface upwards.

**i** You can stow individual objects in the storage compartment beneath the co-driver bench seat.

- ▶ **To fold back the seat surface:** fold the rear edge of the seat surface downwards.
- ▶ Slide the seat surface under the seat backrest into rear anchorage ②.
- ▶ Push the front seat surface downwards until it engages in front anchorage ①.

### Folding the folding seat up/down

**⚠ WARNING** Risk of injury when using the folding seat due to inserted key

The key in the lock of the partition wall sliding door may come into contact with the person on the folding seat.

- ▶ Always remove the key before a person sits on the folding seat.

**⚠ WARNING** Risk of becoming trapped when folding down the folding seat

Hands or other parts of the body may become trapped when you fold down the folding seat.

- ▶ When folding down the folding seat, be careful not to trap your hands or other body parts in the seat's area of movement.

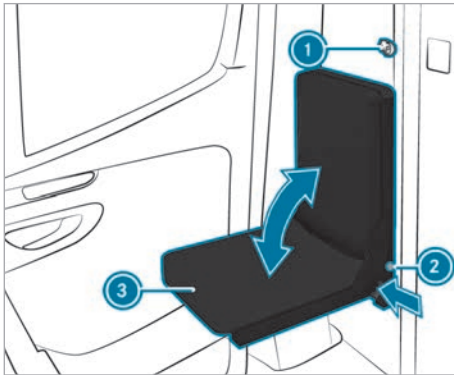

- ▶ Remove key ① from the partition sliding door.
- ▶ **To fold down the seat cushion:** push the push button of catch ② and fold down seat cushion ③ approximately 20 degrees (a fifth of its folding travel).
- ▶ Release the push button of catch ② and fold seat cushion ③ further down by pushing on the center with both hands.
- ① Seat cushion ③ is spring-loaded and will drop down automatically beyond a certain angle of inclination.
- ▶ Move seat cushion ③ until it has locked. The push button on catch ② must be completely flush with the seat frame.
- ▶ **To fold up the seat cushion:** push the push button of catch ② and fold up seat cushion ③

approximately 20 degrees (a fifth of its folding travel).

- ▶ Release the push button of catch ② and fold seat cushion ③ further up by pulling on the center with both hands.
- ▶ Move seat cushion ③ until it has locked. The push button on catch ② must be completely flush with the seat frame.

### Notes for vehicles without a front passenger seat

Retrofitting a seat on the front passenger side is not permitted in a vehicle that is delivered from the factory without a front passenger seat (country-specific).

If, contrary to the vehicle documents, you retrofit a seat on the passenger side and/or make changes to the vehicle electronics, the general operating permit will be rendered invalid.

**⚠ WARNING** Risk of injury or death due to modifications to the restraint system

Vehicle occupants may no longer be protected as intended if alterations are made to the restraint system.

- ▶ Never alter the parts of the restraint system.
- ▶ Never tamper with the wiring or any electronic component parts or their software.

**⚠ WARNING** Risk of accident or injury due to incorrect modifications on electronic component parts

Modification of electronic components, their software or wiring could impair their function and/or the function of other networked component parts or safety-relevant systems.

This can endanger the operating safety of the vehicle.

- ▶ Never tamper with the wiring and electronic component parts or their software.
- ▶ You should have all work on electrical and electronic components carried out at a qualified specialist workshop.



Adhesive label on seat base

You can obtain further information from any authorized Mercedes-Benz Center.

## Head restraints

### Adjusting the head restraint manually

**⚠ WARNING** Risk of accident due to adjusting the vehicle settings while the vehicle is in motion

You could lose control of the vehicle in the following situations in particular:

- If you adjust the driver's seat, the head restraint, the steering wheel or the mirror while the vehicle is in motion
- If you fasten your seat belt while the vehicle is in motion

▶ Before starting the vehicle: in particular, adjust the driver's seat, head restraint, steering wheel and mirror, and fasten your seat belt.

**⚠ WARNING** Risk of injury due to head restraints not being installed or being adjusted incorrectly

If head restraints have not been installed or have not been adjusted correctly, there is an increased risk of injury in the head and neck area, e.g. in the event of an accident or when braking.

- ▶ Always drive with the head restraints installed.
- ▶ Before driving off, make sure for every vehicle occupant that the center of the

head restraint supports the back of the head at about eye level.

Using the head restraint fore-and-aft adjustment, adjust the head restraint so that it is as close to the back of your head as possible.

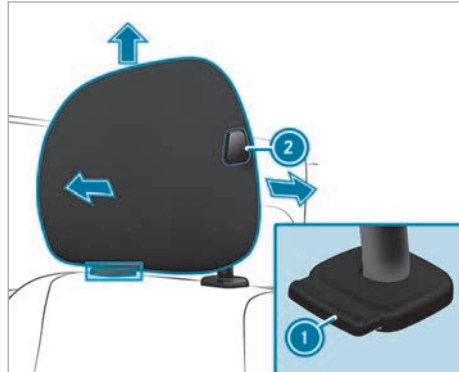

Head restraint (example of luxury head restraint on the driver's seat)

▶ **To raise:** pull the head restraint upwards into the desired position and ensure that it engages.

ⓘ Use the head restraint only when it is engaged.

▶ **To lower:** press release knob ①, slide the head restraint downwards into the desired position and ensure that it engages.

ⓘ Use the head restraint only when it is engaged.

▶ **To move forwards:** press release knob ② and pull the head restraint forwards until it engages in the desired position.

▶ **To move backwards:** press release knob ② and slide the head restraint backwards into the desired position.

▶ **To remove:** press release knob ① and pull the head restraint up and out.

▶ **To install:** press the head restraint with detent on the left-hand side when viewed in the direction of travel into the holes until it engages.

### Switching the seat heating on/off

**⚠ WARNING** Risk of burns due to repeatedly switching on the seat heating

Repeatedly switching on the seat heating can cause the seat cushion and seat backrest padding to become very hot.

In particular, the health of persons with limited temperature sensitivity or a limited ability to react to high temperatures may be affected or they may even suffer burn-like injuries.

▶ Do not repeatedly switch on the seat heating.

To protect against overheating, the seat heating may be temporarily deactivated after it is switched on repeatedly.

**! NOTE** Damage to the seats caused by objects or documents when the seat heating is switched on

When the seat heating is switched on, overheating may occur due to objects or documents placed on the seats, e.g. seat cushions or child seats. This could cause damage to the seat surface.

▶ Make sure that no objects or documents are on the seats when the seat heating is switched on.

#### Requirements:

- The power supply is switched on.

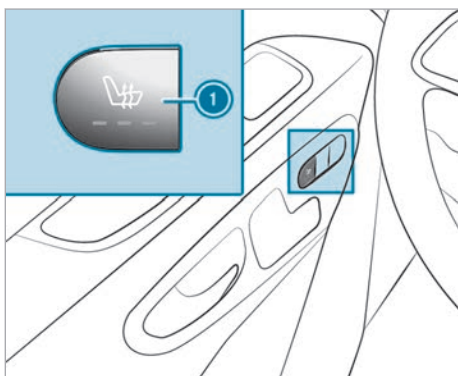

▶ **To switch on:** press the ① button. All indicator lamps on the button light up.

▶ **To lower the level:** press button ① until the required heating level is reached. Depending on the heating level, one to three indicator lamps will light up.

▶ **To switch off:** press button ① until all indicator lamps are off.

① The seat heater automatically switches back out of the three heating levels after 8, 10 and 20 minutes until the seat heater switches off.

### Steering wheel

#### Adjusting the steering wheel

**⚠ WARNING** Risk of accident due to adjusting the vehicle settings while the vehicle is in motion

You could lose control of the vehicle in the following situations in particular:

- If you adjust the driver's seat, the head restraint, the steering wheel or the mirror while the vehicle is in motion
- If you fasten your seat belt while the vehicle is in motion

▶ Before starting the vehicle: in particular, adjust the driver's seat, head restraint, steering wheel and mirror, and fasten your seat belt.

**⚠ WARNING** Risk of accident due to unlocked steering wheel

The steering wheel may move unexpectedly if it is unlocked while the vehicle is in motion.

- ▶ Make sure that the steering wheel is locked before driving off.
- ▶ Never unlock the steering wheel when the vehicle is in motion.

**⚠ WARNING** Risk of entrapment for children when adjusting the steering wheel

Children could injure themselves if they adjust the steering wheel.

- ▶ Never leave children unattended in the vehicle.
- ▶ When leaving the vehicle, always take the SmartKey with you and lock the vehicle.

### Adjusting the steering wheel

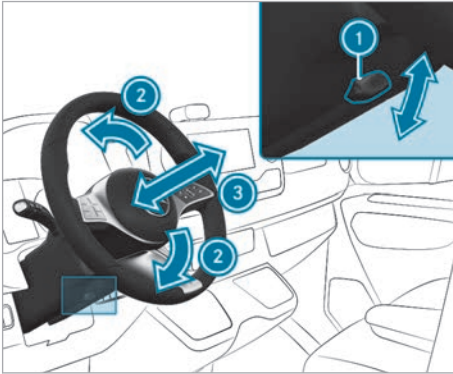

- ① Lever
- ② Steering column height
- ③ Steering column fore-and-aft adjustment

- ▶ **To unlock:** swing lever ① down as far as it will go.  
The steering wheel is unlocked.
- ▶ **To lock:** pull lever ① up as far as it will go.  
The steering wheel is locked.

### Switching the steering wheel heater on/off

#### Requirements:

- The vehicle is switched on.

The steering wheel heater can be switched on and off via a switch below the steering wheel.



- ▶ **To switch on:** push the switch into position ①.  
If indicator lamp ③ lights up, the steering wheel heater is switched on.
- ▶ **To switch off:** push the switch into position ②.

When you switch the vehicle off, the steering wheel heater will switch off.

### Stowage areas

#### Overview of the front stowage compartments

#### Overview of the front stowage compartments

Observe the notes on loading the vehicle (→ page 162).

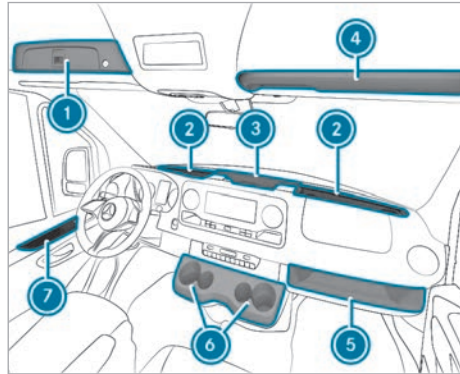

- ① Lockable compartment above windshield (subject to a maximum load of 4 lb (2 kg))
- ② Windshield storage compartment with two cup holders / ashtray stowage space  
Storage compartment with cover, depending on specification
- ③ Center console storage compartment with USB port, charging interface, NFC interface and 12 V socket
- ④ Storage compartment above windshield (subject to a maximum load of 5 lb (2.5 kg))
- ⑤ Front passenger side storage compartment (subject to a maximum load of 11 lb (5 kg))
- ⑥ Cup holder (→ page 68)
- ⑦ Storage compartment in the doors

### Information about the bottle holder

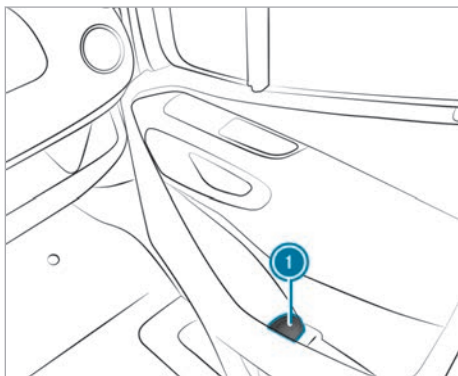

- ① Bottle holder in the front doors (example: front passenger door)

### Cup holders

#### Overview of cup holders in the center console

- ⚠ WARNING** - Risk of accident or injury when using the cup holder while the vehicle is moving

The cup holder cannot secure containers while the vehicle is moving.

If you use a cup holder while the vehicle is moving, the container may be flung around and liquids may be spilled. The vehicle occupants may come into contact with the liquid and if it is hot, they could be scalded. You could be distracted from traffic conditions and you may lose control of the vehicle.

- ▶ Only use the cup holder when the vehicle is stationary.
- ▶ Only use the cup holder for containers of the right size.
- ▶ Close the container, particularly if the liquid is hot.

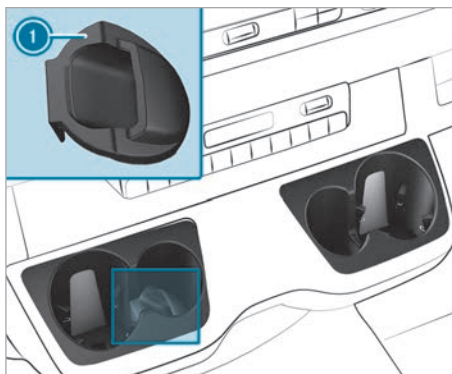

The cup holders for the driver and front passenger are in the center console.

Key holder ① for vehicles with a reduced antenna detection range (KEYLESS-START) is located in the driver's cup holder.

### Ashtray and cigarette lighter

#### Using ashtrays

- ▶ Place the closed ashtray in a cup holder in the stowage compartments near the windshield.
- ▶ Check that the ashtray is seated securely.
- ① Do not place the ashtray in the center console cup holders. It cannot sit securely there.

#### Using the cigarette lighter in the center console

- ⚠ WARNING** Risk of fire and injury from hot cigarette lighter

You can suffer burns if you touch the hot heating element or the hot socket of the cigarette lighter.

In addition, flammable materials can catch fire if:

- you drop the hot cigarette lighter.
- children e.g. hold the hot cigarette lighter to objects.
- ▶ Always hold the cigarette lighter by the knob.
- ▶ Always make sure that the cigarette lighter is out of the reach of children.
- ▶ Never leave children unattended in the vehicle.

**Requirements:**

- The vehicle is switched on.

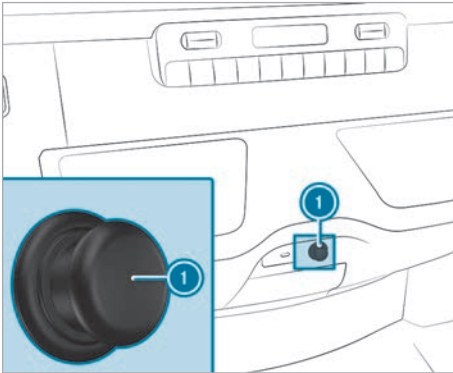

- ▶ Press on the cigarette lighter ①. The cigarette lighter will pop out when the heating element is red-hot.

**Sockets**
**Using 12 V sockets**
**Requirements:**

- Only devices with a maximum power consumption of 180 W (15 A) may be connected.

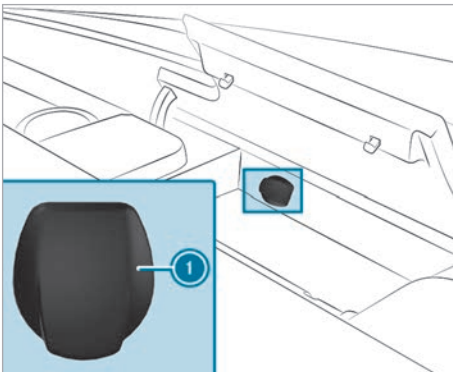
**12 V socket in the storage compartment**

- ▶ Open the lid of the storage compartment in the center console.
- ▶ Fold up cover ① of the socket.
- ▶ Insert the plug of the device.

- ① Depending on the vehicle equipment, the vehicle has additional 12 V sockets:

- in the lower control panel in the front center console
- in the driver's seat
- in the cargo compartment

**Notes on the 115 V socket**

**!** **NOTE** Damage to the auxiliary battery due to full discharge

The auxiliary battery may become damaged if a device with too high a power output is connected when you leave the vehicle, or the auxiliary battery's charge level is low.

- ▶ Only connect devices up to a maximum of 150 W.
- ▶ Do not leave devices connected for longer than four hours.

Vehicles with an auxiliary battery have a run-on function. If you leave the vehicle, you can charge devices over a period of up to four hours. If the vehicle is switched on and off again during the run-on period, the run-on function starts again for another four hours.

**Using the 115 V socket in the center console**

**!** **DANGER** Risk of fatal injuries due to a damaged connecting cable or a damaged socket

You could receive an electric shock if the connecting cable or the 115 V power socket is pulled out of the trim or is damaged or wet.

- ▶ Use only connecting cables that are dry and free of damage.
- ▶ When the vehicle is switched off, make sure that the 115 V power socket is dry.
- ▶ Immediately have the 115 V power socket checked or replaced at a qualified specialized workshop if it is damaged or has been pulled out of the trim.
- ▶ Never plug the connecting cable into a 115 V power socket that is damaged or has been pulled out of the trim.

**⚠ DANGER** Risk of death due to using the socket incorrectly

In particular, you could receive an electric shock:

- If you touch the inside of the socket
- If you insert unsuitable devices or objects into the socket

- ▶ Do not touch the inside of the socket.
- ▶ Only connect suitable devices to the socket.

**⚠ DANGER** Risk of fatal injuries due to electric shock

If you clean the 115 V socket with a wet cloth, you can get an electric shock.

There is a risk of fatal injury!

- ▶ Avoid the area around the 115 V socket when cleaning.

#### Requirements

- Only connect devices with a suitable plug which conforms to the standards specific to the country you are in.
- Only connect devices up to a maximum of 150 W.
- Do not use multiple socket outlets.

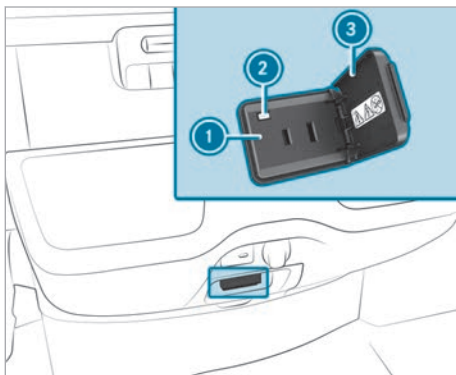

- ▶ Open flap ③.
- ▶ Insert the plug of the device into 115 V socket ①.  
When the on-board electrical system voltage is sufficient, indicator lamp ② lights up.

If you will not be using the 115 V power socket, keep the flap ③ closed.

#### Installing and removing the floor mats

**⚠ WARNING** Risk of accident due to objects in the driver's footwell

Objects in the driver's footwell may impede pedal travel or block a depressed pedal.

This will jeopardize the operating- and road safety of the vehicle.

- ▶ Stow all objects in the vehicle securely so that they cannot get into the driver's footwell.
- ▶ Make sure that there is always sufficient clearance for the pedals.
- ▶ Always install the floor mats securely and as prescribed.
- ▶ Do not use loose floor mats and do not place floor mats on top of one another.

#### Installing

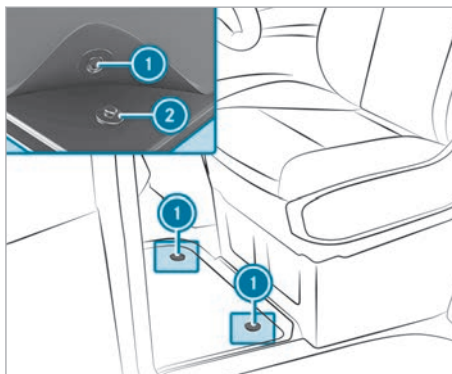

- ▶ Slide the seat backwards.
- ▶ Position the floor mat in the footwell so that it fits flush.
- ▶ Press studs ① onto holders ②, if applicable.
- ▶ Connect the installed driver and passenger footwell floor mats at the contact area.
- ▶ Adjust the seat.

#### Removing

- ▶ Slide the corresponding seat backwards and pull the floor mat off holders ②, if applicable.
- ▶ Remove the floor mat.

## Lighting

### Notes on adjusting the lights when driving abroad

#### Vehicles with halogen or static LED headlamps:

Changing the headlamps is not necessary. The legal requirements will also be fulfilled in countries with left- and right-hand traffic.

### Information about lighting systems and your responsibility

The vehicle's various lighting systems are only aids. The vehicle driver is responsible for adjusting the vehicle's lighting to the prevailing light, visibility, statutory conditions and traffic conditions.

## Light switch

### Operating the light switch

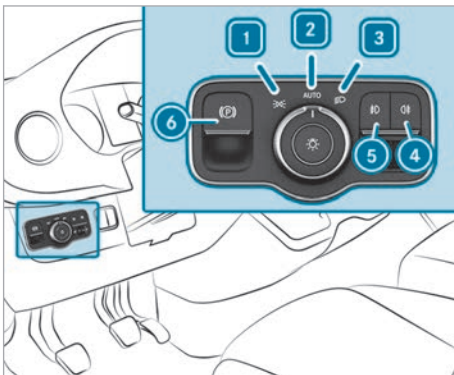

- ▶ **1** Activates or deactivates parking lamps and license plate and instrument lighting.
- ▶ **2** **AUTO** Activates or deactivates automatic driving lights/daytime running lamps (preferred light switch position).
- ▶ **3** Activates or deactivates low beam/high beam.
- ▶ **4** Activates or deactivates the rear fog light.
- ▶ **5** Activates or deactivates the front fog light.
- ▶ **6** Applies or releases the electric parking brake (→ page 117).

**i** If you hear a warning tone when exiting the vehicle, the lights may still be on.

**i** The turn signal light, high beam and high-beam flasher are operated with the combination switch (→ page 72).

**i** Leaving the parking lamps on for several hours drains the battery.  
If the battery is heavily discharged, the parking lamps will switch off automatically to enable the next vehicle start.

### Automatic driving lights function

**▲ WARNING** Risk of accident when the low beam is switched off in poor visibility

When the light switch is set to **AUTO**, the low beam may not be switched on automatically if there is fog, snow or other causes of poor visibility such as spray.

▶ In such cases, turn the light switch to .

The automatic driving lights are only an aid. Responsibility for vehicle lighting rests with you. Turn the light switch from **AUTO** to immediately in the event of fog, snow or spray. Otherwise, the driving lights will be temporarily interrupted.

To switch the automatic driving lights on:

- Turn the light switch to the **AUTO** position. Switch the power supply on: the side lights will automatically switch on or off depending on the brightness of the ambient light.

The daytime running lights will be switched on when the vehicle is started. The side lights and the low beam will also switch on or off depending on the brightness of the ambient light.

When the low beam is switched on, the indicator lamp on the instrument cluster will also switch on.

### Activating/deactivating the fog lights

#### Requirements:

- The light switch is in the or **AUTO** position.
- The vehicle has been switched on or started.

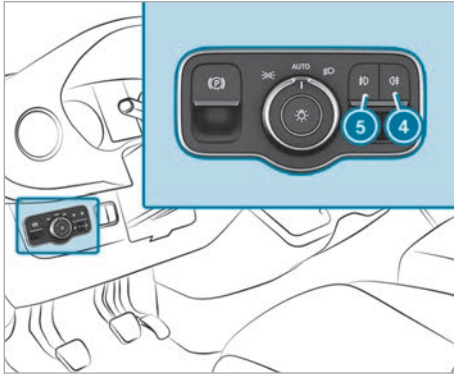

- ▶ To switch the front fog light on or off: press button 5.
- ▶ To switch the rear fog light on or off: press button 4.

Comply with the country-specific regulations for using the rear fog lamp.

### Adjusting headlamp range

#### Requirements:

- The vehicle has been started.

You can use the headlamp range adjuster to adjust the light cone of the headlamps to the vehicle's load condition. When the seats are occupied or the cargo compartment is loaded or unloaded, the light cone will change. This may cause visibility conditions to deteriorate and you could dazzle oncoming traffic.

- i In vehicles with LED headlamps, the headlamp range will be adjusted automatically.

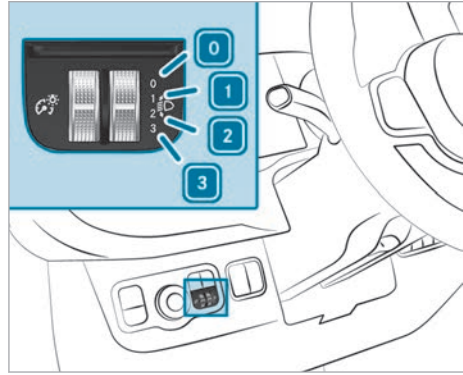

- 0 1 Driver's seat and front passenger seat occupied, select 0 or 1 depending on the desired headlamp range
- 2 Driver's seat and front passenger seat occupied, cargo compartment or loading area laden
- 3 Driver's seat and front passenger seat occupied and maximum permitted rear axle load being used

- ▶ Turn the headlamp range adjuster to the corresponding position.  
The road illumination should be 131.2 ft (40 m) to 328.1 ft (100 m) and the low beam must not dazzle oncoming traffic.
- ▶ If the vehicle is unladen, select position 0.

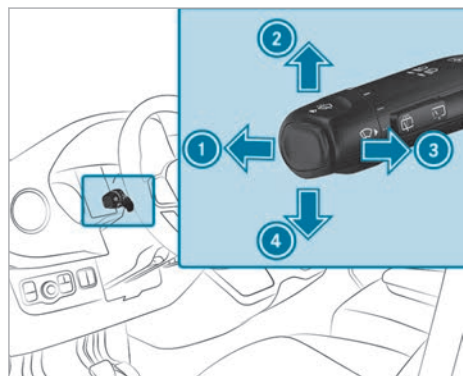

### Operating the combination light switch



- 1 High beam
- 2 Right turn signal light
- 3 Headlamp flashing
- 4 Left turn signal light

- ▶ Use the combination switch to select the desired function.

### Switching on high beam

- ▶ Switch on the low beam (→ page 71).
- ▶ Push the combination switch forwards ①. The  indicator lamp on the instrument cluster will light up. The combination switch will return to its starting position.
- ① In the **AUTO** position, the high beam switches on only in darkness and when the vehicle is switched on.
- ▶ **To switch off:** push the combination switch forwards ① or briefly pull it in the direction of arrow ③ (the action for headlamp flashing switches high beam off). The  indicator lamp on the instrument cluster will go out. The combination switch will return to its starting position.
- ① **Vehicles with Highbeam Assist:** when Highbeam Assist is active, it controls the activation and deactivation of the high beam (→ page 74).

### Headlamp flashing

- ▶ Briefly pull the combination switch in the direction of arrow ③.

### Turn signal light

- ▶ **To indicate:** push the combination switch in the required direction ② or ④ until it engages. When significant steering movements are made, the combination switch will automatically reset itself.
- ▶ **To indicate briefly:** tap the combination switch briefly in the required direction ② or ④. The corresponding turn signal lamp will flash three times.

### Switching the hazard warning light system on/off

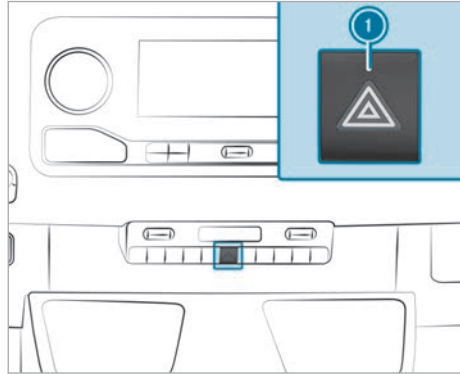

- ▶ Press button ①.

If you operate a turn signal indicator while the hazard warning light system is switched on, only the turn signal lamps on the relevant side of the vehicle will light up.

- ① The hazard warning light system will work even when the vehicle has been switched off.

### Cornering light function



The cornering light improves the illumination of the road over a wide angle in the turning direction, e.g. enabling better visibility in tight bends.

The function is active under the following conditions:

- The speed is less than 37 mph (60 km/h) and the indicator has been switched on or the steering wheel is turned.
- The speed is between 37 mph (60 km/h) and 50 mph (80 km/h) and the steering wheel is turned.

The cornering light may still light up for a short time but will be switched off automatically after a maximum of three minutes.

- i** When reverse gear is engaged, the lighting switches to the opposite side.

## Highbeam Assist

### Adaptive Highbeam Assist function

**⚠ WARNING** Risk of accident despite Adaptive Highbeam Assist

Adaptive Highbeam Assist does not react to:

- Road users without lights, e.g. pedestrians
- Road users with poor lighting, e.g. cyclists
- Road users whose lighting is obstructed, e.g. by a barrier

On very rare occasions, Adaptive Highbeam Assist may fail to recognize other road users with their own lighting, or may recognize them too late.

In these, or in similar situations, the automatic high beam will not be deactivated or will be activated despite the presence of other road users.

- ▶ Always observe the road and traffic conditions carefully and switch off the high beam in good time.

Adaptive Highbeam Assist automatically switches between the following settings:

- Low beam
- High beam

The system detects that vehicle lights are approaching in the opposite direction or driving ahead of the vehicle.

At speeds greater than 19 mph (30 km/h), the system will switch to the following setting:

- If no other road users are detected, high beam will switch on automatically.

At speeds lower than 16 mph (25 km/h) or if there is sufficient street lighting, the system will switch to the following setting:

- High beam will automatically switch off.

### System limits

Adaptive Highbeam Assist cannot take the road, weather or traffic conditions into consideration.

The detection of obstacles may be restricted if:

- visibility is poor, e.g. in fog, heavy rain or snow.
- the sensors are dirty or obscured.

Adaptive Highbeam Assist is only an aid. You are responsible for ensuring correct vehicle lighting in accordance with the prevailing light, visibility and traffic conditions.

The system's optical sensor is located behind the windshield near the overhead control panel.

### Switching Highbeam Assist on/off

#### Requirements:





- The light switch is in the **AUTO** position.

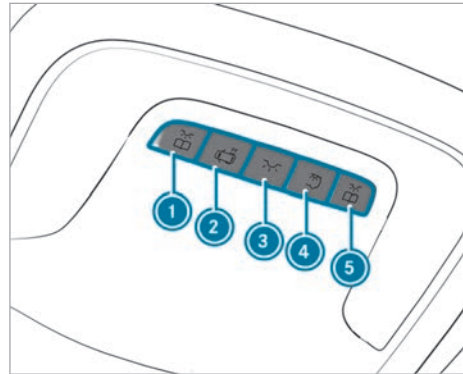

- ▶ **To switch on:** switch on high beam using the combination switch. When the high beam is switched on automatically in the dark, the  indicator lamp will light up on the instrument cluster display.
- ▶ **To switch off:** switch off high beam using the combination switch.

## Adjusting the interior lighting

### Adjusting the interior lighting









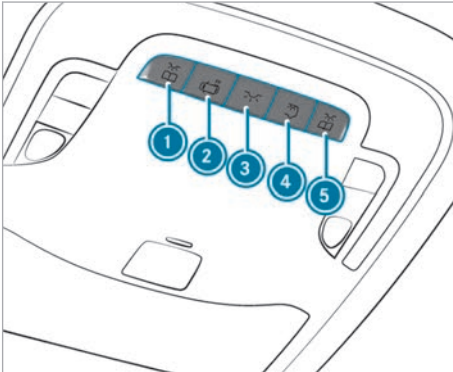

- ▶ **①**  Switches the front-left reading lamp on/off
- ▶ **②** **To switch off the automatic interior lighting control:** press the  button. The interior lighting will switch on automatically if you:
  - Unlock the vehicle
  - Open a door
- ▶ **③**  Switches the (front) interior lighting on/off.
- ▶ **④**  Switches the rear/cargo compartment lamp on/off (not assigned depending on the vehicle equipment).

- ▶   Switches the front-right reading lamp on/off

**Adjusting the interior lighting for body manufacturer add-on equipment**





- ▶ **To switch the front left reading lamp on/off:** press button .
- ▶ **To deactivate automatic interior lighting control:** press button . Interior lighting control will switch on automatically if you do the following, for example:
  - Unlock the vehicle
  - Open a door
- ▶ **To switch the front interior lighting on/off:** press button .
- ▶ **To switch body manufacturer lamps on/off:** press button  (not assigned depending on the vehicle equipment).
  - Your vehicle may be equipped with a functional feedback system:  will light up in red if the body manufacturer lamps are switched on.
  - If the body manufacturer lamps have been switched on manually, they will also remain switched on for an extended period of time after locking.

-  This period of time is shortened if there is undervoltage in the starter battery.
-  If the body manufacturer lamps have been switched off automatically to protect the battery, restart the vehicle before switching them on again.
-  The body manufacturer lamps can be switched on only when the battery voltage is stable.

- ▶ **To switch the front right reading lamp on/off:** press button .

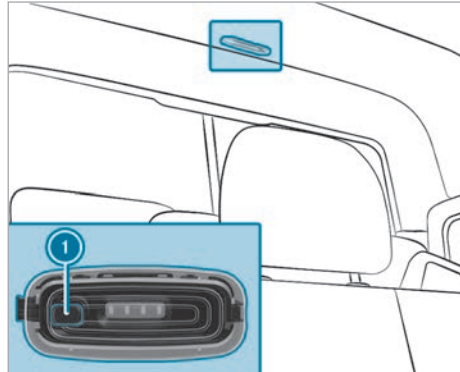
**Switching the rear passenger compartment interior lighting on/off**



- ▶  Switches rear passenger compartment/cargo compartment lamp on or off

**Motion detector**

 **WARNING** Risk of injury due to laser beam of the motion detector

The motion detector emits non-visible radiation from LEDs that are classified as class 1M lasers.

This may damage the retina in the following situations:

- If you look directly into the unfiltered laser beam of the motion detector for an extended period.
- If you look directly into the laser beam of the motion detector with optical instruments, such as glasses or magnifying glasses.

- ▶ Never look directly into the motion detector.

The motion detector is located in the cargo compartment behind the partition, in the middle of the roof.

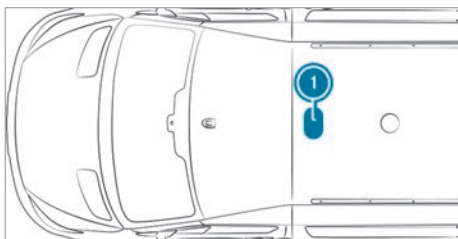

#### ① Position of motion detector

If the vehicle is equipped with a motion detector, the cargo compartment lamp is also activated via the motion detector.

If the motion detector detects movement in the cargo compartment while the vehicle is stationary, the cargo compartment lamp will switch on for approximately two minutes.

The cargo compartment lamp will be switched on via the motion detector in the following situations:

- The vehicle is stationary, the parking brake is applied and you are not depressing the brake pedal.
- The selector lever is in position **P** and you are not depressing the brake pedal.
- The vehicle has not been locked from the outside using the key.

If no change to the vehicle (e.g. a door opening) is detected over several hours, the motion detector will automatically switch off. This prevents the battery from discharging.

## Changing bulbs

### Instructions for replacing illuminants

**▲ WARNING** Risk of burns from hot component parts whilst replacing a bulb

Bulbs, lamps and plug connectors can become very hot during operation.

When replacing a bulb, you could burn yourself on these component parts.

- ▶ Allow the component parts to cool down before replacing the bulbs.

### Important safety notes

- Before changing the bulbs, switch off the vehicle's lighting system. This will prevent a short circuit.
- Use only spare bulbs of the same type and with the correct voltage.
- Use bulbs only in enclosed lamps that have been designed for them.
- Do not use any illuminant that has been dropped or has scratches on its glass tube. Otherwise, the illuminant may explode.
- The illuminant may explode under the following conditions:
  - if it is hot and you touch it
  - if you drop it
  - if you scratch it
- Stains on the glass tube will reduce the service life of the illuminant. Do not touch the glass tube with your bare hands. If necessary, clean the glass tube with alcohol or spirits while it is cold and wipe it down with a lint-free cloth.
- Protect light bulbs from humidity and do not bring them into contact with liquids.

Always ensure the bulbs are firmly secured.

If your vehicle is equipped with LED modules, you can check this as follows: the light cone will move from top to bottom and back again when the vehicle starts. For this to work, low beam needs to have been switched on before the vehicle is started.

Bulbs and lamps are major elements in vehicle safety. Therefore, ensure that they are always working. Have the headlamp setting checked regularly.

If the new light source also does not light up, consult a qualified specialist workshop.

### Replacing front light bulbs (vehicles with halogen headlamps)

#### ■ Overview of illuminant types

You can replace the following light sources.

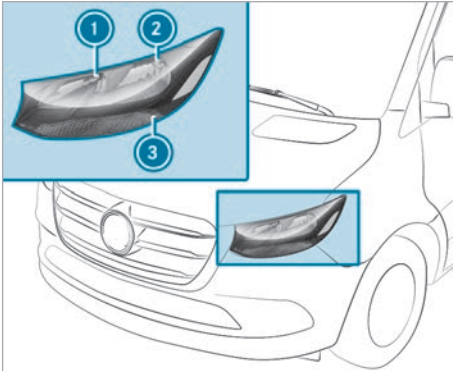

Halogen headlamps

- ① High beam/daytime running lights: H15 55 W/15 W
- ② Low beam/perimeter light: H7 55 W/W 5 W
- ③ Turn signal light: 3457 NAK 28 W

#### Replacing bulbs in the halogen headlamp

##### Requirements:

- **Low beam:** light source type H7 55 W
- **High beam/daytime running lights:** light source type H15 55 W/15 W
- **Perimeter lights:** light source type W 5 W
- **Turn signal lights:** light source type 3457 NAK 28 W

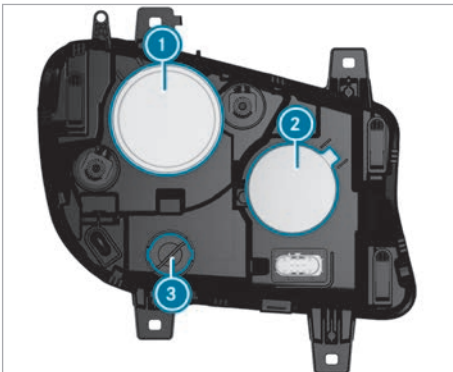

- ① Low beam/perimeter light housing cover
  - ② High beam/daytime running lights housing cover
  - ③ Turn signal light socket
- ▶ Switch off the lighting system.

- ▶ **Low beam/perimeter light:** pull housing cover ① rearward to remove it.
- ▶ Pull the socket rearward to remove it.
- ▶ Remove the illuminant from the socket.
- ▶ Insert the new illuminant into the socket such that the base of the bulb rests fully against the base of the socket.
- ▶ Align and insert the socket.
- ▶ Attach housing cover ①.
- ▶ **High beam/daytime running lights:** pull housing cover ② rearward to remove it.
- ▶ Turn the socket counter-clockwise and pull it out.
- ▶ Remove the illuminant from the socket.
- ▶ Insert the new illuminant into the socket such that the base of the bulb rests fully against the base of the socket.
- ▶ Insert the socket and turn it clockwise.
- ▶ Attach housing cover ②.
- ▶ **Turn signal light:**
- ▶ Turn socket ③ counter-clockwise and remove it.
- ▶ Gently turn the illuminant counter-clockwise and take it out of the socket.
- ▶ Insert the new illuminant into the socket and turn it clockwise.
- ▶ Insert socket ③ and turn it clockwise.

#### Replacing rear bulbs

##### Overview of rear illuminant types

You can replace the following light sources.

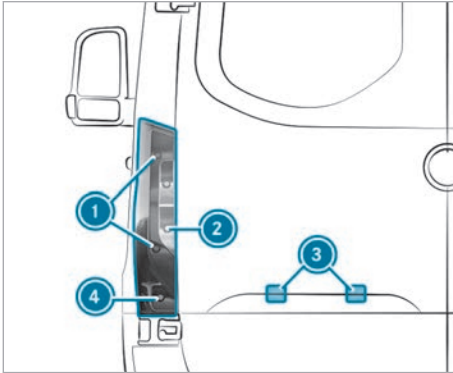

Vehicles with standard tail lamps

- ① Brake lights/tail lamps/perimeter lights: P 21 W
- ② Backup lamp: P 21 W
- ③ License plate lamp: W 5 W
- ④ Rear fog light: P 21 W

You can replace the following light sources.

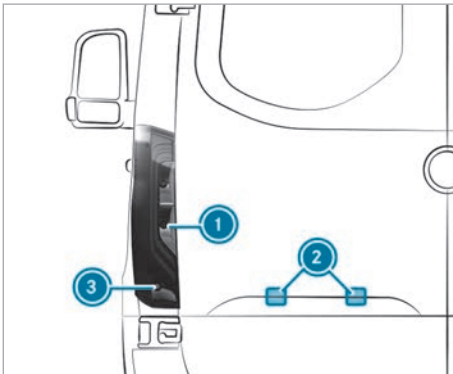

Vehicles with partial LED tail lamps

- ① Backup lamp: P 21 W
- ② License plate lamp: W 5 W
- ③ Rear fog light: P 21 W

### ■ Replacing the tail lamp bulbs

#### Requirements:

- **Brake light/tail light/perimeter light:** illuminant type P 21 W
- **Backup lamps:** illuminant type P 21 W
- **Rear fog lights:** illuminant type P 21 W

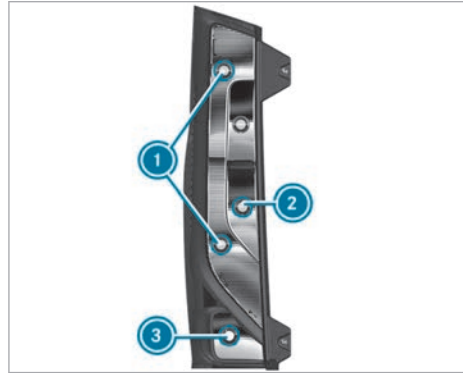

- ① Brake light/tail light/perimeter light
  - ② Backup lamps
  - ③ Rear fog light
- ▶ Switch off the lighting system.  
▶ Open the rear-end door.

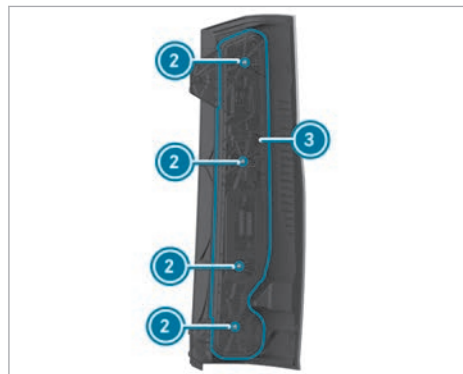
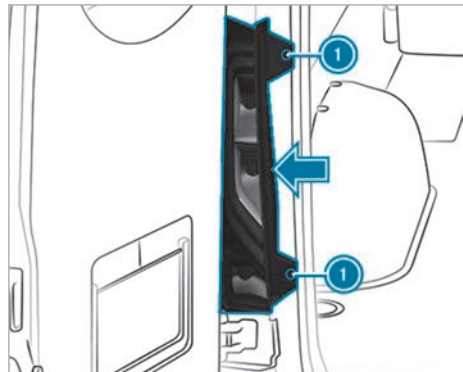

### Removing

- ▶ Remove screws ① and pull out the tail lamp in the direction of the arrow.
- ▶ Remove the plug from bulb mount ③.
- ▶ Remove screws ② and remove bulb mount ③ from the tail lamp.
- ▶ Gently turn the illuminant counter-clockwise and take it out of the socket.
- ▶ Insert the new illuminant into the socket and turn it clockwise.

### Installing

- ▶ Set bulb mount ③ on the tail lamp and screw in screws ②.
- ▶ Press the plug into bulb mount ③.
- ▶ Insert the tail lamp and screw in screws ①.

### License plate lamp

#### Requirements:

- **License plate lamp:** light bulb type W 5 W

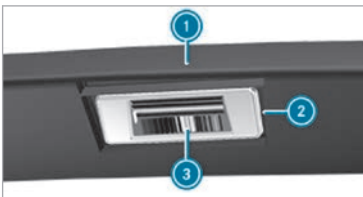

- ▶ Switch off the lighting system.
- ▶ Place a screwdriver, for example, at opening ② between lamp ③ and panel ① and carefully pry off the lamp ③.
- ▶ Remove lamp ③ from panel ①.
- ▶ Rotate the bulb holder by around 45° and detach it from the lamp.
- ▶ Remove the light bulb.
- ▶ Insert the new bulb into the bulb holder.
- ▶ Insert the bulb holder into the lamp and rotate it by around 45°.
- ▶ Insert the lamp into the panel opening until it engages.

### Replacing interior light bulbs

#### Replacing rear interior lamps

#### Requirements

- ① For the standard bulb failure indicator function to work correctly, only light bulbs that are the

same type and power as those installed during production may be used.

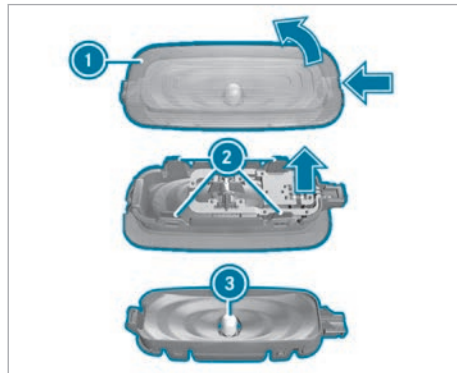

- ▶ Switch off the interior lighting.
- ▶ Press in the catch spring of lens ① with a suitable object, e.g. a screwdriver, and then lever off the lens with the lamp housing.
- ▶ **To remove the lens from the lamp housing:** press the lugs of lens ② inwards.
- ▶ Remove light bulbs ③ from the lamp housing.
- ▶ Insert the new light bulb.
- ▶ Position the lens on the lamp housing and engage it.
- ▶ Align the lens with the lamp housing and engage it.

## Windshield wipers

### Switching the windshield wipers on and off

#### Requirements:

- The power supply is switched on.

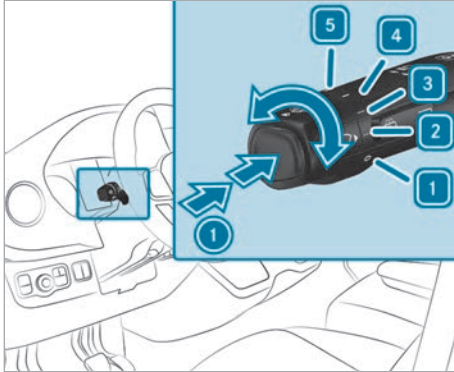

- ① Single wipe/wiping with washer fluid
- 1 0 Windshield wipers off
- 2 Intermittent wiping, normal  
Vehicles with rain sensors: automatic wiping, normal
- 3 Intermittent wiping, frequent  
Vehicles with rain sensors: automatic wiping, frequent
- 4 Continuous wiping, slow
- 5 Continuous wiping, fast

- ▶ Turn the combination switch to the corresponding position 1 - 5.
- ▶ **Single wipe:** press button ① on the combination switch in the direction of arrow as far as the first pressure point.
- ▶ **Washing:** press button ① on the combination switch in the direction of arrow as far as the second pressure point.

### Switching the rear window wiper on and off

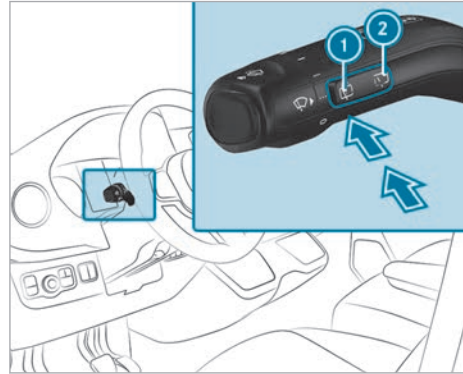

- ① Single wipe/wash
- ② Intermittent wiping

▶ **Single wipe:** press button ① to the pressure point.

▶ **Wiping with washer fluid:** press button ① beyond the pressure point.

▶ **To switch intermittent wiping on or off:** press button ②.

The symbol will appear on the instrument cluster when the rear window wiper is switched on.

### Replacing the windshield wiper blades

**⚠ WARNING** Risk of becoming trapped if the windshield wipers are switched on while wiper blades are being replaced

If the windshield wipers begin to move while you are changing the wiper blades, you can be trapped by the wiper arm.

- ▶ Always switch off the windshield wipers and vehicle before changing the wiper blades.

**⚠ WARNING** Risk of injury from using the windshield wipers when the hood is open

If the windshield wipers start moving when the hood is open, you could be trapped by the wiper linkage.

- ▶ Always switch off the windshield wipers and vehicle before opening the hood.

### Replacing the wiper blades

- ❗ If the wiper blades are worn out, they will no longer wipe the windshield properly. Replace the wiper blades twice a year, preferably in spring and fall.

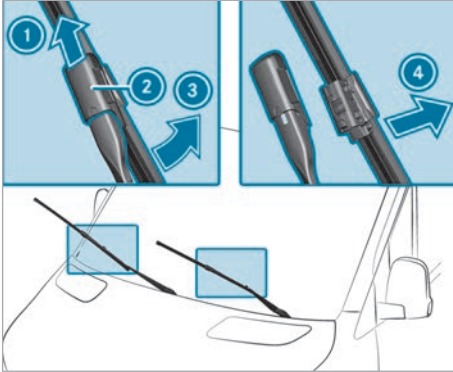

- ▶ Fold the wiper arm away from the windshield.
- ▶ Hold wiper arm and fold the wiper blade away from wiper arm in the direction of arrow ③ as far as it will go.
- ▶ Slide catch ② upwards in the direction of arrow ① until it engages.
- ▶ Fold the wiper blade back onto the wiper arm.
- ▶ Remove the wiper blade from the wiper arm in the direction of arrow ④.
- ▶ Insert new wiper blade in the holder on wiper arm.

When doing so, take into account the different lengths of the wiper blades:

- Driver's side: long wiper blade
- Front passenger side: short wiper blade
- ▶ Slide catch ② downwards until it engages.
- ▶ Fold wiper arm back onto the windshield.

### Replacing the windshield wiper blades (WET WIPER SYSTEM)

- ⚠ **WARNING** Risk of becoming trapped if the windshield wipers are switched on while wiper blades are being replaced

If the windshield wipers begin to move while you are changing the wiper blades, you can be trapped by the wiper arm.

- ▶ Always switch off the windshield wipers and vehicle before changing the wiper blades.

- ⚠ **WARNING** Risk of injury from using the windshield wipers when the hood is open

If the windshield wipers start moving when the hood is open, you could be trapped by the wiper linkage.

- ▶ Always switch off the windshield wipers and vehicle before opening the hood.

### Replacing the wiper blades

- ❗ If the wiper blades are worn out, they will no longer wipe the windshield properly. Replace the wiper blades twice a year, preferably in spring and fall.

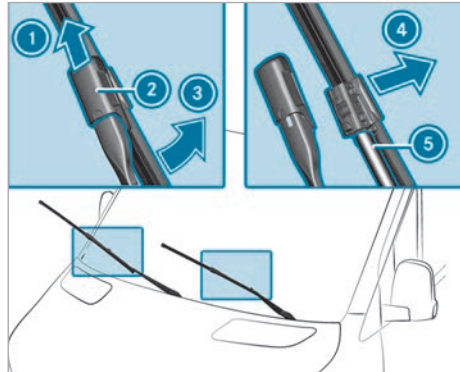

- ▶ Fold the wiper arm away from the windshield.
- ▶ Hold wiper arm and turn the wiper blade away from wiper arm in the direction of arrow ③ as far as it will go.
- ▶ Slide catch ② upwards in the direction of arrow ① until it engages.
- ▶ Remove wiper blade from the wiper arm in the direction of arrow ④.
- ▶ Carefully remove hose ⑤ from the wiper blade.
- ▶ Attach hose ⑤ to the new wiper blade.
- ▶ Insert new wiper blade in the holder on wiper arm.

When doing so, take into account the different lengths of the wiper blades:

- Driver's side: long wiper blade
- Front passenger side: short wiper blade

- ▶ Slide catch ② downwards until it engages.
- ▶ Fold the wiper blade back onto the wiper arm.
- ▶ Fold wiper arm back onto the windshield.

### Replacing the rear window wiper blades

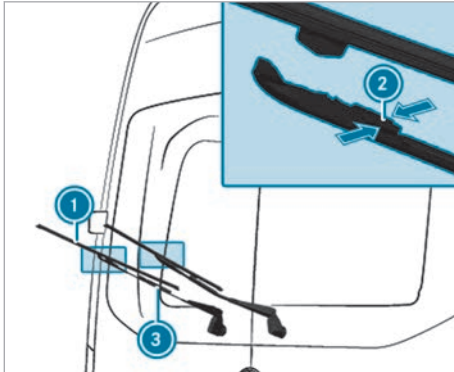

- ▶ Fold wiper arm ③ away from the rear window.
- ▶ Press both retaining clips ② together in the direction of the arrow and swivel the wiper blade away from the wiper arm.
- ▶ Pull wiper blade ① upwards out of the holder on wiper arm ③.
- ▶ Insert new wiper blade ① in the holder on wiper arm ③.
- ▶ Push new wiper blade ① onto wiper arm ③ until the retaining clips engage.
- ▶ Fold wiper arm ③ back onto the rear window.

## Mirrors

### Operating the outside mirrors

**⚠ WARNING** Risk of accident due to adjusting the vehicle settings while the vehicle is in motion

You could lose control of the vehicle in the following situations in particular:

- If you adjust the driver's seat, the head restraint, the steering wheel or the mirror while the vehicle is in motion
- If you fasten your seat belt while the vehicle is in motion

- ▶ Before starting the vehicle: in particular, adjust the driver's seat, head restraint,

steering wheel and mirror, and fasten your seat belt.

**⚠ WARNING** Risk of accident due to misjudgment of distance when using the front-passenger mirror

The outside mirror on the front passenger side reflects objects on a smaller scale. The objects in view are in fact closer than they appear.

- ▶ Therefore, always look over your shoulder to check the actual distance between you and the road users traveling behind you.

### Adjusting the outside mirrors manually

- ▶ Adjust the outside mirrors to the correct position manually.
- ▶ **To engage an outside mirror that has been pushed out of position:** push the outside mirror into position manually.

### Adjusting the outside mirrors electrically

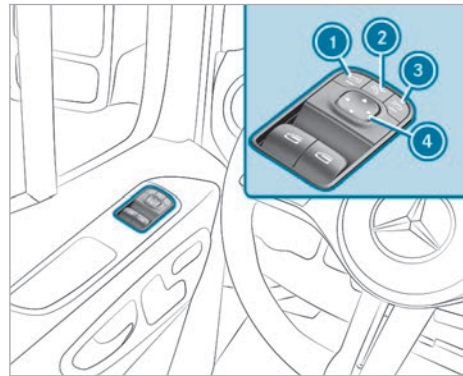

Example image

**!** **NOTE** Damage to the electric outside mirrors due to folding in by hand or by force

If the electric outside mirrors are folded in or out manually, the outside mirrors may be damaged and will not engage properly.

If the outside mirrors are not folded when you have the vehicle washed at an automatic car wash, the washing brushes may forcibly fold in and damage the outside mirrors.

- ▶ Fold the outside mirrors in and out electrically only.

▶ Fold in the outside mirrors before having the vehicle washed at an automatic car wash.

- ▶ Before setting off, switch on the power supply or the vehicle.
- ▶ **To fold in or out:** briefly press button ②.
- ▶ **To select:** use button ① or ③ to select the outside mirror to be adjusted.
- ▶ **To adjust:** use button ④ to set the position of the mirror surface.
- ▶ **To engage an outside mirror that has been pushed out of position:** press and hold button ②.  
You will hear a click and the mirror will audibly engage in position. The outside mirror will be set to the correct position.

#### Resetting the outside mirrors

- ① If the battery has been disconnected or completely discharged, the outside mirrors must be reset. Only then will the automatic mirror folding function work properly.
- ▶ Switch on the power supply or the vehicle.
- ▶ Briefly press button ②.

#### Heating the outside mirrors

- ▶ **Vehicles without a rear window heater:** at low temperatures, the mirror heater will switch on automatically once the vehicle has been started.
- ▶ **Vehicles with a rear window heater:** at low temperatures, the mirror heater will switch on automatically once the vehicle has been started. The mirror heater can also be switched on together with the rear window heater using the rear window heater button.

#### Using the digital inside rearview mirror

The vehicle may be equipped with a digital inside rearview mirror. This uses a rear-mounted camera on top of the roof to provide a better view to the rear. The inside rearview mirror can be used either as a standard inside rearview mirror or as a display.

To prevent glare from the digital inside rearview mirror, first set the digital inside rearview mirror as the standard inside rearview mirror.

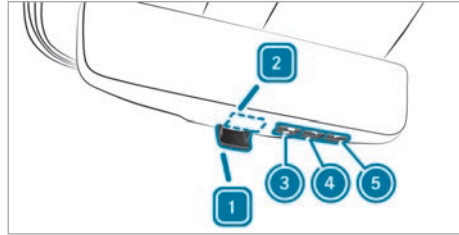

Digital image noise may occur on the display under certain circumstances in unfavorable ambient light.

Certain types of sunlight, e.g. sun low on the horizon or light from another intense light source, can reduce the display's contrast and cause it to become too bright. In such situations, objects on the display may be obscured or difficult to see. In these cases, be particularly careful and adapt your driving style accordingly.

Drivers must always wear the necessary personal visual aids required for them to drive a vehicle. Drivers with presbyopia (age-related long-sightedness) should, if necessary, wear visual aids with multifocal lenses to be sufficiently able to see traffic including via the displays.

- ① If the camera on top of the roof at the rear is dirty, the image may be impaired. In this case, clean the camera manually with a damp cloth. Observe the notes on cleaning the digital inside rearview mirror (→ page 174).

- ▶ **To use the standard inside rearview mirror:** move the switch to position ①.
- ▶ **To use the display:** move the switch to position ②.

#### Adjusting the display brightness

- ① The digital inside rearview mirror is equipped with light sensors on the front and back and automatically adjusts the brightness of the display to the ambient light. Do not cover the light sensors, e.g. with a sticker.

- ▶ Press menu button ③ once.
  - ▶ Press button ④ to reduce the display brightness.
- or
- ▶ Press button ⑤ to increase the display brightness.

#### Adjusting the angle of the camera

- ▶ Press menu button ③ twice.

- ▶ Press button ④ to move the angle downwards.

or

- ▶ Press button ⑤ to move the angle upwards.

#### Activating and deactivating the rear view camera image

The vehicle may be equipped with a rear view camera with image in the inside rearview mirror.

- ▶ To activate, put the vehicle in reverse gear or press button ⑤.
- ▶ To deactivate, take the vehicle out of reverse gear or press button ⑥ again.

#### Error mode of the digital inside rearview mirror

If a system error occurs, e.g. if the camera fails, a crossed-out camera will appear at the top left of the display and no camera image will be visible in the mirror.

- ▶ Switch to the standard inside rearview mirror if there is a system error.

If the vehicle is equipped with a rear view camera with image in the inside rearview mirror and a system error occurs, a crossed out camera with the number 2 will appear on the left side of the display.

In this case, no camera image is available for maneuvering.

#### Dimming the inside rearview mirror

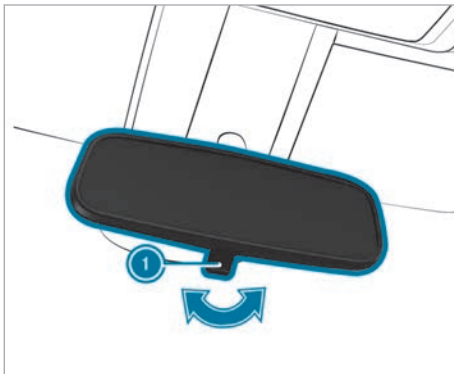





- ▶ Fold anti-glare lever ① in the direction of the arrow.

## Overview of climate control systems









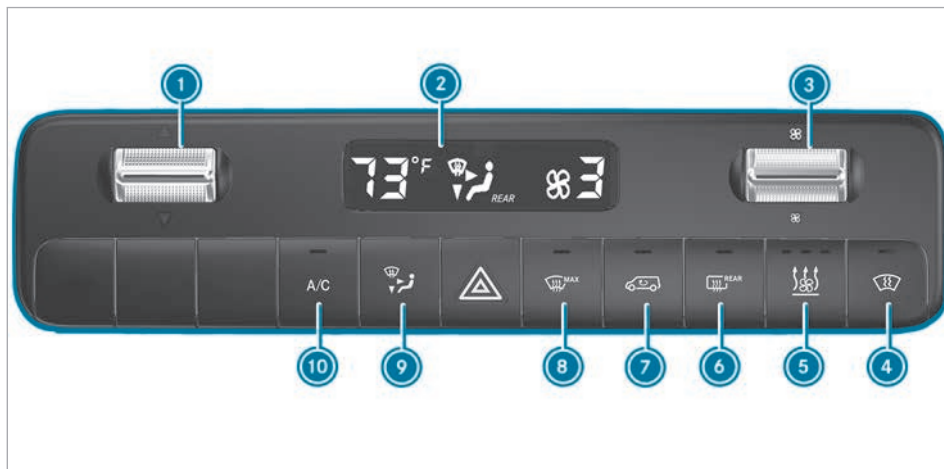

### Heating system overview



- ① Sets the temperature
- ②  Switches the rear window defroster on/off (→ page 90)
- ③  Switches footwell air distribution on/off
- ④  Switches windshield defroster on/off (→ page 89)
- ⑤  Vehicle switched on: Max Comfort mode cut-in; Vehicle switched off: Pre-entry climate control
- ⑥ Sets the airflow
- ① The indicator lamps on the buttons signal that the functions in question have been activated.

## TEMPMATIC overview



- ①  Sets the temperature
  - ②  Display
  - ③  Sets the airflow
  - ④  Vehicles with windshield heaters: switches the windshield heater on/off (→ page 90)
  - ⑤  Vehicle switched on: Max Comfort mode cut-in; Vehicle switched off: pre-entry climate control
  - ⑥  Vehicles with rear window heaters: switches the rear window heater on/off (→ page 90)
  - ⑦  Switches air-recirculation mode on/off (→ page 89)
  - ⑧  Switches windshield defrosting on/off (→ page 89)
  - ⑨  Sets the air distribution (→ page 89)
  - ⑩  Switches the A/C function on/off (→ page 88)
- ⓘ The indicator lamps on the buttons signal that the functions in question have been activated.

## THERMOTRONIC overview

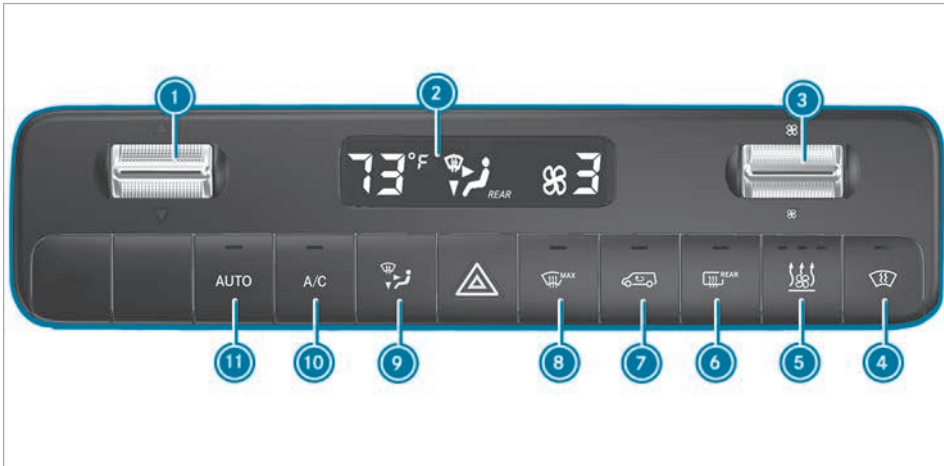

- 1 Sets the temperature
  - 2 Display
  - 3 Sets the airflow
  - 4 Vehicles with windshield heater: switches the windshield heater on/off (→ page 90)
  - 5 Vehicle switched on: Max Comfort mode cut-in; Vehicle switched off: pre-entry climate control
  - 6 Vehicles with rear window defroster: switches the rear window defroster on/off (→ page 90)
  - 7 Switches air-recirculation mode on/off (→ page 89)
  - 8 Switches windshield defrosting on/off (→ page 89)
  - 9 Sets the air distribution (→ page 89)
  - 10 Switches the A/C function on/off (→ page 88)
  - 11 Sets front climate control to automatic mode (→ page 89)
- The indicator lamps on the buttons signal that the functions in question have been activated.

## Operating climate control systems

## Notes on energy-saving air-conditioning

Using the heating and climate control functions has a direct effect on the vehicle's range. For this reason, the heating/air-conditioning output

will automatically be reduced depending on the selected drive program (→ page 104).

| Drive program | Vehicle characteristics                             |
|---------------|---|
| (Comfort)     | Normal heating and air-conditioning output          |
| (ECO)         | Reduced heating and air-conditioning output         |
| (MAX Range)   | Heavily reduced heating and air-conditioning output |

Depending on the vehicle's equipment, you can use MaxComfort mode to set an increased heating and air-conditioning output.

- To cool the high-voltage battery in very high outside temperatures, the cooling of the vehicle interior can be automatically reduced or switched off for a short time.

In drive program , the best possible heating output will be achieved in Auto mode (THERMOTRONIC) or with a low to moderate blower setting.



In drive programs and , there may be an increased risk of fogging up. If the windows fog up, increase the blower setting and select drive program if necessary. If necessary, switch on the "defrost windshield" function as well (→ page 90).

A reduction in the heating/air-conditioning output may mean that it will take longer than usual to

reach the desired vehicle interior temperature or that it cannot be reached at all.

### MaxComfort mode



Depending on its equipment, your vehicle may have a MaxComfort mode.

When the vehicle is switched on, you can activate MaxComfort in all drive programs by pressing the  button on the air-conditioning control panel. The maximum output of the heating/climate control system will be activated in this mode. This makes it possible to heat the vehicle more quickly, but can have a negative impact on range. The function is switched on when the indicator lamp on the  button is lit up.

### Energy-saving mode (Cargo Van)

Depending on the vehicle's equipment, it may have an energy-saving mode to reduce energy consumption when the vehicle is switched on.

When energy-saving mode is activated, the output of the heating/climate control system will be significantly reduced. The display on the instrument cluster will show a message reading **Heating/Climate Control Energy-saving Active** briefly and the  symbol will be displayed permanently.

Energy-saving mode will be activated in drive programs  and  if:

- Front doors are opened immediately after the vehicle stops
  - The front windows or doors are open for an extended period of time
- i** Energy-saving mode will remain active for a few minutes even after the front doors have closed. By briefly switching on the "defrost windshield" function (→ page 89), you can deactivate energy-saving mode for a certain period of time. When the "defrost windshield" function is switched on, energy-saving mode will always be deactivated.

Energy-saving mode will automatically be deactivated:

- at speeds above approximately 43 mph (70 km/h)
- when the interior temperature falls below a certain level

In addition, comply with the following air-conditioning instructions in order to minimise energy consumption:

- Select as low a blower setting as possible.
- Use the "defrost windshield" function only briefly until the windshield is clear again.
- Vehicles with an air-conditioning system: ventilate the vehicle for a short time in warm weather. To achieve quicker cooling, briefly switch the climate control to air-recirculation mode. This will accelerate the cooling process and the desired vehicle interior temperature will be reached more quickly.
- Vehicles with seat heating: using the seat heating in conjunction with a medium vehicle interior temperature will result in lower fuel consumption than selecting a high vehicle interior temperature.

### Switching the climate control system on/off

▶ **To switch on:** set the airflow to 1 or higher.

▶ **To switch off:** set the airflow to 0 or **OFF**. **OFF** will appear on the climate control system display.

- i** When the climate control system is switched off, the windows may fog up more quickly. Switch the climate control system off only briefly.

### Switching the A/C function on/off

#### Requirements:

- The climate control system has been switched on (→ page 88).

The A/C function controls the climate and dries the air inside the vehicle.

▶ Press the  button.

- i** Switch off the A/C function only briefly. Otherwise, the windows could fog up more quickly.
- i** Condensation may leak from the underside of the vehicle in cooling mode. This is not a sign of a defect.

### Automatically regulating climate control

#### Requirements:



- The climate control system has been switched on (→ page 88).

#### Switching on automatic climate control

In automatic mode, the temperature, airflow and air distribution are regulated and kept constant.

- Press the **AUTO** button.  
The display will show the temperature. The airflow and air distribution will disappear from the display.

#### Switching off automatic climate control

- Use the  rocker switch to change the airflow setting or the  button to change the air distribution (→ page 89).  
The other setting will remain unaffected by the change.

### Information on the air distribution settings

The symbols on the display indicate the vents through which the air is being directed.

Heating system

 Directs air to the footwell vents

TEMPMATIC

 Defroster and center air vent

 All vents

 Center vents

 Center and footwell vents

THERMOTRONIC

 Defroster vent

 Defroster and center air vent

 All vents

 Defroster and footwell vents

 Center vents

 Center and footwell vents

 Footwell vents

### Setting the air distribution

#### Requirements:







- The climate control system is switched on.
- Press the  button repeatedly until the desired air distribution appears in the air conditioning system display.

### Defrosting the windows







#### Windows fogged up on the inside Vehicles with heating system

- Press the  button.  
When windshield defrosting is switched on, the temperature and airflow cannot be adjusted.
- Close the front air vents (→ page 90).

#### Vehicles with TEMPMATIC or THERMOTRONIC

- Press the  button and, if necessary, use the  button to direct air onto the windshield .
- Increase the airflow as necessary and close the front air vents (→ page 90).
- If the windows remain fogged up: press the  button.  
When windshield defrosting is switched on, the temperature and airflow cannot be adjusted.  
 will appear on the climate control system display.
- Vehicles with a windshield heater:** press the  button.

Depending on operation, you can achieve faster defrosting and drying of the windshield with the following settings:

- Use the  button to direct air onto the windshield .
- Set the temperature  and the airflow  to maximum using the rocker switches.
- Close the front air vents (→ page 90).
- Vehicles with windshield heater: switch on the  windshield heater (→ page 90).
- For vehicles with heating systems: set the air distribution so that the  and  LEDs are off (→ page 85).

#### Windows fogged up on the outside

- Switch on the windshield wiper (→ page 80).

### Switching air-recirculation mode on/off

- Press the  button.  
The interior air will be recirculated.

Air-recirculation mode will switch off automatically.

-  When air-recirculation mode is switched on, the windows may fog up more quickly. Switch on air-recirculation mode only briefly.

Air-recirculation mode will automatically switch on in the following cases:

- in high outside temperatures
- while the vehicle is driving through a tunnel (vehicles with THERMOTRONIC automatic climate control only)
- when the wiping with washer fluid function is switched on (→ page 80)

The indicator lamp on the  button will not light up in this case. After a maximum of 30 minutes, outside air will automatically be introduced again.

### Switching the windshield heater on or off

- ❗ In the event of high outside temperatures, the windshield heater may not switch on.
- ▶ Press the  button.  
If the indicator lamp on the button lights up, the windshield heater has switched on.
- ❗ The windshield heater switches off automatically after a few minutes.
- ❗ If the battery voltage is too low, it may not be possible to switch the windshield heater on. If the battery voltage becomes too low while the windshield heater is in operation, the windshield heater will switch off automatically.

### Switching the rear window heater on or off

- ▶ Press the  button.  
If the indicator lamp lights up, the rear window heater is switched on.

### Operating air vents

#### Adjusting the front-compartment air vents

**⚠ WARNING** Risk of burns or frostbite due to being too close to the air vents

Very hot or very cold air can flow from the air vents.

- ▶ Make sure that all vehicle occupants always maintain a sufficient distance from the air vents.
- ▶ If necessary, direct the airflow to another area of the vehicle interior.

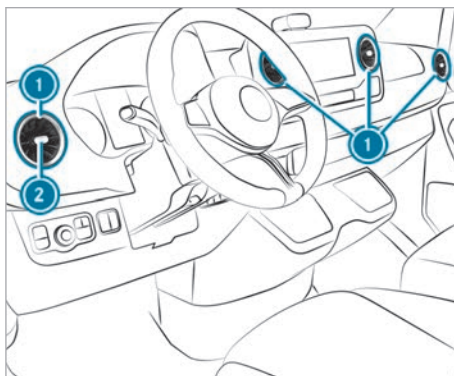

- ▶ **To open or close:** hold center **2** of air vent **1** and turn it to the left or right as far as it will go.
- ▶ **To set the airflow direction:** hold center of air vent **1** and move it up or down or to the left or right **2**.

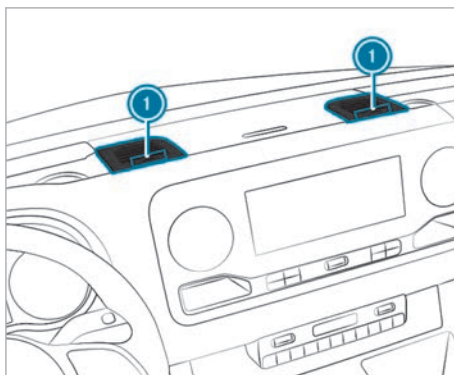

- ▶ **To open or close:** turn adjustment wheels **1** on the high-power air vents to the left or right as far as they will go.
- ❗ Cooled air will flow out of the high-power air vents. Heating will not be possible. Open the high-power air vents only in summer during cooling mode and keep them closed in winter, to avoid negative influences on energy consumption and thus the achievable range.

### Operating cargo compartment ventilation

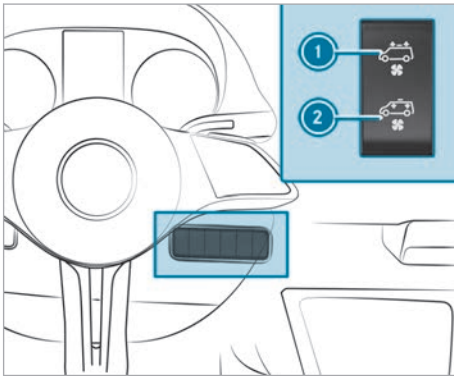

If your vehicle is equipped with a roof ventilator, you can admit fresh air to the cargo compartment or extract air from it as well.

- ▶ Switch on the vehicle.
- ▶ **To switch on and extract:** press the top section of switch ①.  
The roof ventilator will remove used air from the cargo compartment.
- ▶ **To switch on and admit fresh air:** press the bottom section of switch ②.  
The roof ventilator will feed fresh air into the cargo compartment.
- ▶ **To switch off:** place the switch in the center position.

### Pre-entry climate control

#### Notes on pre-entry climate control

**⚠ WARNING** Risk of fatal injury due to exposure to extreme heat or cold in the vehicle

If persons, particularly children, are subjected to prolonged exposure to intense heat or cold, there is a risk of severe injury or even death.

- ▶ Never leave persons, particularly children, unattended in the vehicle.

**⚠ WARNING** Risk of burns due to repeatedly switching on the seat heating

Repeatedly switching on the seat heating can cause the seat cushion and seat backrest padding to become very hot.

In particular, the health of persons with limited temperature sensitivity or a limited ability to react to high temperatures may be affected or they may even suffer burn-like injuries.

- ▶ Do not repeatedly switch on the seat heating.

To protect against overheating, the seat heating may be temporarily deactivated after it has been switched on repeatedly.

Depending on the vehicle equipment, the following functions can be activated as needed during pre-entry climate control:

- Automatic climate control
- Blower
- Seat heating
- Steering wheel heater
- Mirror heater
- Rear window heater

#### Setting pre-entry climate control when the vehicle is unlocked

On-board computer:

- ▶ Settings ▶ eSprinter
- ▶ Pre-entry Climate Control

With this function, the seats can be briefly pre-warmed or pre-cooled before you get into the vehicle.

- ▶ Activate or deactivate the function.

#### Selecting seats

- ▶ Use the **Only Driver's Seat** setting to specify whether only the driver's seat or also the front passenger seat is air conditioned.  
The seat-specific functions of pre-entry climate control, such as seat heating, will be performed for the selected seats.

If pre-entry climate control is enabled, an LED on the climate bar of the air conditioning control panel will light up blue for a cooled vehicle and red for a heated vehicle.

#### Activating/deactivating pre-entry climate control when the vehicle is unlocked

Requirements:

- The high-voltage battery is charged sufficiently.
- The function is activated on the on-board computer.

▶ **To activate:** unlock the vehicle. The climate control functions will be activated for up to five minutes for pre-heating and pre-cooling.

▶ **To switch off:**

- Press the  button on the air conditioning control panel.
- Locking by key (if the vehicle is parked for fewer than 15 minutes).

**i** Pre-entry climate control will not be terminated via the automatic locking mechanism.

**i** Seat heating will also remain activated after the vehicle has been started.

### Setting pre-entry climate control at departure time

On-board computer:

↳ Settings ▶ eSprinter  
 ▶▶ Pre-entry Climate Control

#### Setting the departure time

The air inside the vehicle can be heated, ventilated or cooled to the set temperature when the vehicle is parked.

When the vehicle is connected to power supply equipment, priority will be given to charging the high-voltage battery to a specified minimum state of charge.

With active pre-entry climate control, the state of charge of the high-voltage battery may be reduced, even if the charging cable connector is inserted.

When the set temperature is changed, climate control mode will automatically be updated.

**i** The set departure times are used for the vehicle's pre-entry climate control system and to predict the state of charge at the time selected. Additional information on the charging settings (→ page 109).

**i** If the Range Assistant function is active, it automatically determines, during a charging stop, the approximate time at which the desired state of charge will be attained. This will be used as an approximate departure time for pre-entry climate control and will be set automatically. Previously set departure times cannot be changed when the function is active. The automatically determined departure time can be activated or deactivated via the eSprinter menu.

▶ **To select a seat:** use the **Driver's Seat Only** setting to specify whether only the driver's seat

or also the front passenger seat is air-conditioned.

Pre-entry climate control will take place for the selected seats.

If a departure time is set, a yellow LED will appear on the air conditioning control panel. In addition, an LED on the air conditioning control panel will indicate when pre-entry climate control is activated. It will light up blue when the vehicle is being cooled and red when it is being heated

### **Activating/deactivating pre-entry climate control at departure time**

Requirements:

- The high-voltage battery is charged sufficiently.
- The vehicle is switched off.
- The windows are closed.
- The doors to the passenger compartment are closed.
- The date and time are set correctly.

▶ **To activate:** set the departure time (→ page 109).

Pre-entry climate control at departure time will switch on a maximum of 60 minutes before the selected departure time. It will remain active for another ten minutes if departure is delayed.

▶ **To deactivate the pre-entry climate control at departure time early:** press the  button on the air conditioning control panel or switch off the preselection of the time in the **eSprinter** menu.

**i** Seat heating will also remain activated after the vehicle has been started.

### Operating immediate pre-entry climate control via the air conditioning control panel

#### Requirements

- The vehicle must be switched off.
- The high-voltage battery is charged sufficiently.

Air conditioning of the vehicle interior can continue for up to 30 minutes, e.g. if the journey is interrupted.

▶ Press the  button on the air conditioning control panel.

▶ Set the temperature on the air conditioning control panel.

An LED will indicate when pre-entry climate control is activated. It will light up blue when the vehicle is being cooled and red when it is being heated.

## Driving

### Notes on electric mode

**⚠ DANGER** Risk of fire and explosion from excessive internal pressure of the high-voltage battery

In the event of a vehicle fire, flammable gas can escape and ignite.

- ▶ If there is an unusual smell, smoke or burn marks, stop the charging process immediately.
- ▶ Leave the danger zone immediately. Secure the danger area at a sufficient distance.
- ▶ Call the fire service.

**⚠ WARNING** Risk of chemical burns and poisoning from damaged high-voltage battery

If the housing of the high-voltage battery has been damaged, electrolyte and gases may leak out.

- ▶ Avoid contact with the skin, eyes or clothing.
- ▶ Immediately rinse electrolyte splashes off with water and seek medical attention straight away.

Observe the following notes on vehicle noise emissions and the acoustic vehicle alerting system:

- The vehicle is equipped with an all-electric drive system and produces considerably lower vehicle noise emissions than a vehicle with a combustion engine.

This is why the vehicle is equipped with a sound generator, which serves as an acoustic vehicle alerting system (AVAS). This safety system is prescribed by law.

The external noise produced by the sound generator can be heard in the vehicle interior at low speeds and does not constitute a malfunction.

- The sound generator will generate speed-dependent vehicle noise emissions when the vehicle is driving forwards or reversing at a speed of up to around 20 mph (30 km/h). This will help other road users, particularly pedestrians and cyclists, to hear your vehicle better.

- From a speed of 12 mph (20 km/h), the acoustic vehicle alerting system will gradually switch off.
- Despite the sound generator, the vehicle still may not be heard by other road users. Adapt your driving style accordingly.

### Manually disconnecting the high-voltage on-board electrical system

**⚠ DANGER** Risk of death and fire due to modified and/or damaged components of the high-voltage on-board electrical system

The vehicle's high-voltage on-board electrical system is under high voltage. If you modify component parts in the vehicle's high-voltage on-board electrical system or touch damaged component parts, you may be electrocuted. In addition, modified and/or damaged components may cause a fire.

In the event of an accident or impact to the underbody, components of the high-voltage electrical system may be damaged although the damage is not visible.

- ▶ Never make any modifications to the high-voltage on-board electrical system.
- ▶ Do not switch on or use the vehicle if its high-voltage on-board electrical system components have been modified or damaged.
- ▶ Never touch damaged components of the high-voltage on-board electrical system.
- ▶ After an accident, do not touch any components of the high-voltage on-board electrical system.
- ▶ After an accident, have the vehicle transported away.
- ▶ Have the components of the high-voltage on-board electrical system checked at a qualified specialist workshop and replaced if necessary.

#### Requirements:

- The  restraint system warning lamp lights up in the instrument cluster, e.g. after an accident.
- The vehicle is badly damaged, e.g. after an accident, and the restraint system components have not been triggered.

- The vehicle has not been started.
- The vehicle is secured against rolling away.

### Using the high-voltage disconnect device in the engine compartment

Only disconnect the drive system manually under the prerequisites in the specified situations.

- ▶ Open the hood (→ page 169).

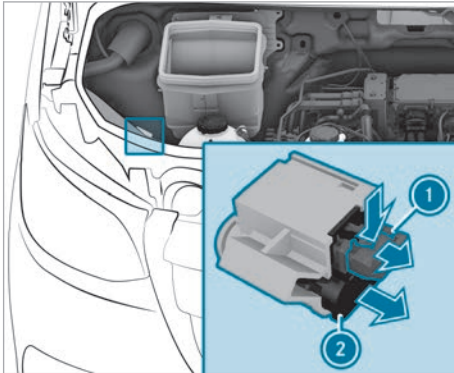

- ▶ Press release tab ① in the direction of the arrow and pull it out.
- ▶ Pull high-voltage disconnect device ② in the direction of the arrow until it engages. The drive system has been disconnected. The capacitors of the high-voltage on-board electrical system are completely discharged after one minute at the earliest.

Any work on the drive system – may only be carried out at a qualified specialist workshop, even if it has been deactivated manually –.

### Using the high-voltage disconnect device in the seat box of the driver's seat

The drive system may only be manually disconnected in the situations conditionally mentioned above. The high-voltage disconnect device is located in the seat box of the driver's seat and is only to be used in an emergency by rescue teams.

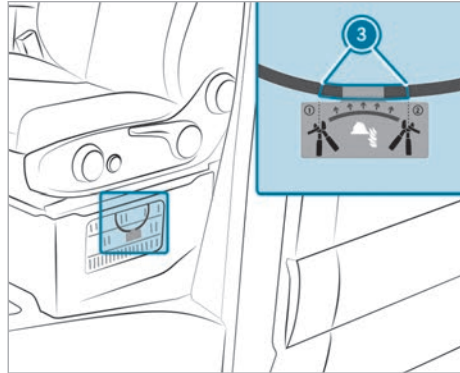

- ▶ Open the fuse box in the driver's seat box (→ page 185).
- ▶ Using an appropriate tool, cut the orange cable at positions ③ as shown on the sign, and remove the severed piece of cable. The drive system has been disconnected. The capacitors of the high-voltage on-board electrical system are completely discharged after one minute at the earliest.

Any work on the drive system – may only be carried out at a qualified specialist workshop, even if it has been deactivated manually –.

## Regenerative brake system

### Function of the regenerative brake system

To charge the high-voltage battery while driving, the electric motor is operated as a generator depending on the selected recuperation level, in overrun mode and during braking. As soon as you release the accelerator pedal when the vehicle is in motion, recuperation in overrun mode is initiated. This does not apply if you have selected the recuperation level **D** **+** **+** (no recuperation).

The regenerative brake system has the following characteristics:

- it supports braking with electronically controlled brake force boosting
- it converts the kinetic energy of the vehicle into electric energy

You can use the steering wheel paddle shifters to manually adjust the intensity of recuperation in overrun mode (→ page 96).

### System limits

The braking effect of the electric motor during recuperation in overrun mode may be reduced or may not be available at all in the following situations:

- with increasing state of charge of the high-voltage battery
- if the high-voltage battery is not yet at operating temperature
- when driving at very slow speeds (near standstill)
- in transmission position **N**
- during and after ESP® intervention

### Manually setting recuperative deceleration

You can use the steering wheel paddle shifters to manually adjust the intensity of recuperation in overrun mode.

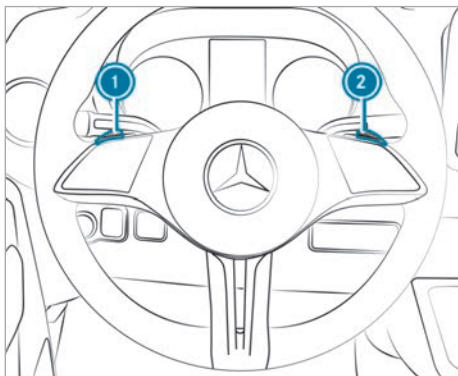

The higher the recuperation, the more sharply the vehicle is braked when coasting and the more electric energy is fed into the high-voltage battery.

**i** Recuperation level **D** is automatically set after restarting the vehicle.

- ▶ **To increase recuperation:** briefly pull steering wheel paddle shifter **1**.
- ▶ **To decrease recuperation:** briefly pull steering wheel paddle shifter **2**.
- ▶ **To select **D** **AUTO**:** pull and hold steering wheel paddle shifter **1** or **2**.

The following recuperation levels are available:

- **D** **AUTO** Radar-supported recuperation taking road and traffic conditions into account, or

intelligent and anticipatory recuperation with ECO Assist

- **D** **+** **+** No recuperation: the vehicle coasts, rolls freely, e.g. for driving on highways
- **D** **+** Decreased recuperation: slight deceleration in overrun mode
- **D** Normal recuperation
- **D** **-** Increased recuperation: maximum deceleration in overrun mode, e.g. for driving in the city

The instrument cluster display shows the currently set recuperation level on the transmission position display, e.g. **D** **-**.

**i** In addition to radar detection, ECO Assist analyzes other data for the expected route. This allows ECO Assist to help optimally adjust the driving style for the route ahead, use minimal energy and recuperate.

### Switching on the power supply or drive system using the start/stop button

**⚠ WARNING** Risk of accident and injury due to children left unattended in the vehicle

If you leave children unattended in the vehicle, they could, in particular:

- open doors, thereby endangering other persons or road users.
- get out and be struck by oncoming traffic.
- operate vehicle equipment and become trapped, for example.

In addition, the children could also set the vehicle in motion by, for example:

- releasing the parking brake.
  - changing the gearbox position.
  - starting the vehicle.
- ▶ Never leave children unattended in the vehicle.
  - ▶ When leaving the vehicle, always take the key with you and lock the vehicle.
  - ▶ Keep the key out of reach of children.

**⚠ WARNING** Risk of accident and injury due to animals left unsecured or unattended in the vehicle

If you leave animals in the vehicle unattended or unsecured, they could possibly press buttons or switches.

An animal may:

- Activate vehicle equipment and become trapped, for example
- Switch systems on or off and endanger other road users

Unsecured animals may be thrown around in the vehicle in the event of an accident or sudden steering and braking maneuvers and injure vehicle occupants in the process.

- ▶ Never leave animals in the vehicle unattended.
- ▶ Always correctly secure animals while driving, e.g. using a suitable animal carrier.

#### Requirements:

- The key is in the detection range of the antenna (→ page 39) and the key battery is not flat.
- The brake pedal is not depressed.

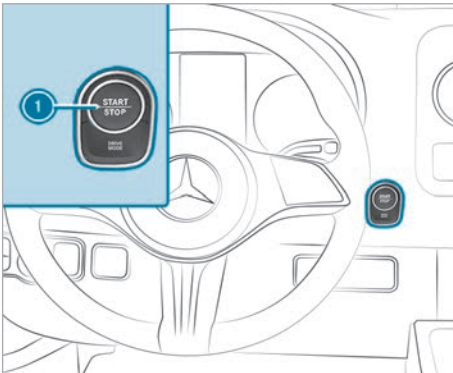

- ▶ **To switch on the power supply:** press button ① once. You can, for example, activate the windshield wiper.

The power supply will be switched off again when one of the following conditions is met:

- you open the driver's door
- you press button ① twice more

- ▶ **To switch on the drive system:** press button ① twice. The indicator lamps on the instrument cluster will light up.

The drive system will be switched off again if one of the following conditions is met:

- You do not start the vehicle within 15 minutes.
- You press button ① once.

#### Starting the engine

##### Starting the vehicle with the start/stop button

#### Requirements:

- The key is within the detection range of the antenna (→ page 39) and the key battery is not flat.
- The transmission is in position **P** or **N**.

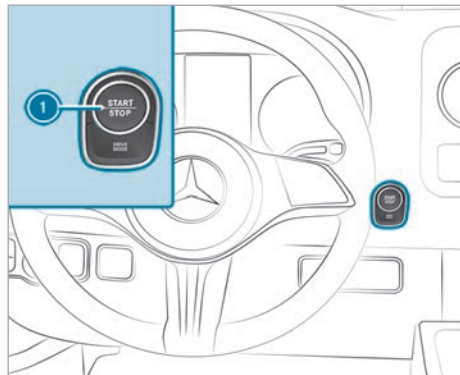

- ▶ Depress the brake pedal and press button ① once. The vehicle will start. Once the vehicle can be driven, the **READY** display will appear on the instrument cluster.
- ▶ If the vehicle does not start: switch off any unnecessary consumers and press button ① once.
- ▶ If the vehicle still does not start and the display message **Place Key in the Marked Space** See [Operator's Manual](#) appears in the instrument cluster: start the vehicle in emergency operation mode.

- ❗ If you leave the driver's seat after starting the vehicle, the instrument cluster will show a display message reading  **Vehicle is Ready to Drive Switch Off the Ignition Before Exiting.** If you do not sit in the driver's seat within the next minute, the vehicle will automatically switch off.

### Starting the vehicle in emergency operation mode

If the vehicle does not start and the display message **Place Key in the Marked Space See Operator's Manual** appears on the instrument cluster, you can start the vehicle in emergency operation mode

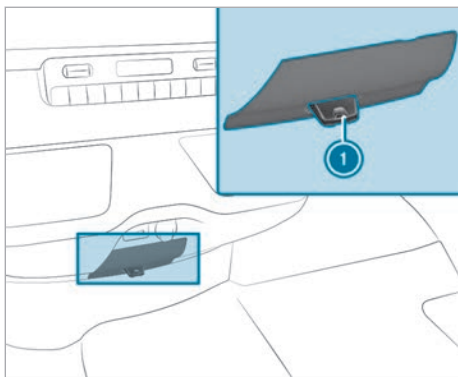

- ▶ Remove key ❶ from your key ring.
- ▶ Insert key ❶ into the slot.
- ▶ The vehicle will start after a short time.

If you remove the key from the slot, it will still be possible to drive the vehicle. For any further engine starts to be carried out, however, the key must be located in the slot throughout the journey.

- ▶ Have key ❶ checked at a qualified specialist workshop.

### If the vehicle does not start:

- ▶ Leave key ❶ in the slot.
  - ▶ Depress the brake pedal.
  - ▶ Start the vehicle with the start/stop button.
- ❗ You can also switch on the power supply or the drive system with the start/stop button.

Note any information on the display messages that may be shown on the instrument cluster.

### Breaking-in notes

After the vehicle has been delivered or after repairs, the sensor system of some driving systems and driving safety systems adjusts itself automatically after the vehicle has been driven a certain distance. Full system effectiveness is not reached until the end of this teach-in process.

New or replaced brake pads, brake discs and tires provide optimal braking and grip only after several hundred kilometers. Until then, compensate for the reduced braking effect by depressing the brake pedal with greater force.

### Driving tips

#### Notes on driving

-  **WARNING** Risk of accident due to objects in the driver's footwell

Objects in the driver's footwell may impede pedal travel or block a depressed pedal.

This will jeopardize the operating and road safety of the vehicle.

- ▶ Stow all objects in the vehicle securely so that they cannot get into the driver's footwell.
- ▶ Make sure that there is always sufficient clearance for the pedals.
- ▶ Ensure there are non-slip attachments for floor mats and carpets.
- ▶ Do not lay multiple floor mats or carpets on top of one another.

-  **WARNING** Risk of accident due to incorrect footwear

Incorrect footwear includes, for example:

- Shoes with platform soles
- Shoes with high heels
- Slippers

There is a risk of an accident.

- ▶ Always wear suitable footwear so that you can operate the pedals safely.

-  **WARNING** Risk of accident if the vehicle is switched off while driving

If you switch off the vehicle while driving, safety functions are restricted or no longer available.

This may affect the power steering system and the brake force boosting, for example.

You will need to use considerably more force to steer and brake, for example.

- ▶ Do not switch off the vehicle while driving.

**⚠ WARNING** Risk of skidding and accident if recuperation level is increased on a slippery road surface

If the recuperation level is increased on a slippery road surface, the drive wheels may lose grip.

- ▶ Do not increase the recuperation level on a slippery road surface.

**⚠ WARNING** Risk of accident and injury due to being under the influence of alcohol and drugs while driving

Drinking and driving and/or taking drugs and driving are very dangerous combinations. Even a small amount of alcohol or drugs can affect your reflexes, perceptions and judgment.

The possibility of a serious or even fatal accident are greatly increased when you drink or take drugs and drive.

- ▶ Do not drink or take drugs and drive or allow anyone to drive who has been drinking or taking drugs.

**⚠ WARNING** Risk of accident and injury from operating mobile communications equipment

If you operate mobile communication equipment when driving, you will be distracted from the traffic situation. This could also cause you to lose control of the vehicle.

The probability of a serious or even fatal accident increases greatly if you operate mobile communication equipment when driving.

- ▶ Only operate mobile communication equipment when the vehicle is stationary.

For your own safety, observe the following points when operating mobile communications equipment:

- Please observe the legal requirements for the country in which you are driving.
- While driving, operate mobile communications equipment only when the traffic conditions per-

mit it. You could otherwise be distracted from traffic, cause an accident and injure yourself and others.

**!** **NOTE** Vehicle damage due to failure to observe the maximum permissible clearance height

If the vehicle height exceeds the maximum permissible clearance height, the roof and other vehicle parts may be damaged.

- ▶ Please observe the maximum clearance height indicated.
- ▶ If the vehicle exceeds the permissible clearance height, do not drive in.
- ▶ Take the modified vehicle height into account in the case of roof superstructures or other carrier systems.

**i** Please bear in mind that all the speeds indicated in this Operator's Manual are approximate and subject to a certain tolerance.

#### ■ Notes on the speed limitation

**⚠ WARNING** Risk of injury through exceeding the specified tire load-bearing capacity or the permissible speed rating

Exceeding the specified tire load rating or the permissible speed rating may lead to tire damage and to the tires bursting.

- ▶ Therefore, only use tire types and sizes approved for your vehicle model.
- ▶ Observe the tire load rating and speed rating required for your vehicle.

Find out about the maximum permissible speed resulting from the tires, i.e. tires and tire pressure. Please observe the legal requirements for tires for the country you are in.

**i** **Vehicles with tachograph:** due to the different certification requirements for the tachograph and instrument cluster, the displayed speeds may differ. Please keep to the speed display in the instrument cluster.

You can permanently limit the speed of your vehicle.

Mercedes-Benz recommends a qualified specialist workshop for programming the speed limitation.

Note that you cannot exceed a programmed speed limitation when overtaking.

On downhill gradients, the speed limitation may be exceeded. Apply the brakes if necessary.

Display messages will warn you that you are approaching the speed limitation.

### Information about driving abroad

#### Service

An extensive Mercedes-Benz service is also available abroad. Nevertheless, please remember that services or spare parts may not be available immediately. The relevant workshop directories are available from an authorized Mercedes-Benz Center.

### Information about transport by rail

Transporting your vehicle by rail may be subject to certain restrictions or require special measures to be taken in some countries due to varying tunnel heights and loading standards.

You can obtain information about this from any Mercedes-Benz Service Center.

### Information on braking

**⚠ WARNING** Risk of skidding and accident if recuperation level is increased on a slippery road surface

If the recuperation level is increased on a slippery road surface, the drive wheels may lose grip.

▶ Do not increase the recuperation level on a slippery road surface.

#### Downhill gradients

On long, steep gradients, you can reduce the load on the brakes by increasing the level of recuperation (→ page 96). This is particularly important when driving a laden vehicle.

Recuperation allows the vehicle to be decelerated without placing a load on the brake system. This prevents the brakes from overheating and causing excessive wear.

#### Heavy and light loads

If the brakes have been subjected to heavy use, do not park the vehicle immediately. Keep driving for a short while. The brakes cool down more quickly in the air stream.

If you only make moderate use of the brakes, you should occasionally test their effectiveness. To do this, brake more firmly from a higher speed while paying attention to the traffic conditions. The brakes will grip better as a result.

#### Wet road surfaces

If you have been driving for a long time in heavy rain without braking, there may be a delayed response when you first apply the brakes. This may also occur after driving through a car wash or deep water. In such cases you will need to depress the brake pedal more firmly. Maintain a greater distance from the vehicle in front.

While paying attention to the traffic conditions, you should brake the vehicle firmly after driving on a wet road surface or through a car wash. This heats the brake discs so that they dry more quickly, thus protecting them against corrosion.

Impaired braking effect on roads treated with de-icing salt:

- A layer of salt on the brake discs or brake linings can increase braking distances considerably, or braking may only be one-sided.
- Maintain an especially large safety distance from the vehicle in front.

To remove the layer of salt:

- Apply the brakes from time to time, paying attention to traffic conditions.
- Depress the brake pedal gently at the end of a journey and when starting a new journey.

#### Checking the brake lining thickness

In addition to the monitoring undertaken by the brake lining wear sensor, you can regularly monitor and check all the brake linings for material wear by means of a visual inspection.

If you are unable to check the brake lining wear on the inside of the wheels, remove the wheels if you have the necessary specialist skills. Otherwise visit a qualified specialist workshop.

If the brake lining material thickness is less than 0.12 in (3 mm), have the brake linings checked and if necessary replaced at a qualified specialist workshop.

Do not rely solely on the brake lining wear sensor.

It is also strongly recommended that you have the brake linings checked at a qualified specialist workshop, and not only during every service prompted by the maintenance interval display. Also check the brake linings before long journeys, and whenever the wheels are removed.

Check the brake linings in the following situations:

- during every service according to the maintenance interval
- before long journeys

- every time a tire is replaced
- conduct regular visual inspections for your own safety

### New brake discs and brake linings

New brake linings and brake discs only reach their optimal braking effect after a few hundred miles (a few hundred kilometers).

Until then, compensate for the reduced braking effect by depressing the brake pedal with greater force. For safety reasons, Mercedes-Benz recommends that you only have brake linings and brake discs installed in your vehicle which have been approved by Mercedes-Benz.

Other brake discs or brake linings may compromise the safety of your vehicle.

Always replace all brake discs and brake linings on an axle at the same time. Always install new brake linings when replacing brake discs.

### Information about driving on wet roads

#### Hydroplaning

**⚠ WARNING** Risk of hydroplaning due to low tire profile

Depending on the level of water on the road, hydroplaning may occur.

- ▶ Adapt your speed to the prevailing conditions.
- ▶ Avoid tire ruts and brake carefully.
- ▶ Change tires when the tread is too low.

Therefore, in heavy rain or other conditions in which hydroplaning can occur, drive as follows:

- Reduce your speed.
- Avoid tire ruts.
- Brake carefully.

#### Driving on flooded roads

Bear in mind that vehicles traveling in front or in the opposite direction create waves. This may cause the maximum permissible depth of water to be exceeded. These notes must be observed under all circumstances. Otherwise, you could damage the drive system, electrics and transmission.

If you have to drive on stretches of road on which water has collected, please bear in mind the following:

- the water level of standing water must not reach above the lower edge of the front bumper.
- you must drive no faster than walking pace.

### Information about driving in winter

**⚠ WARNING** Risk of skidding and accident if recuperation level is increased on a slippery road surface

If the recuperation level is increased on a slippery road surface, the drive wheels may lose grip.

- ▶ Do not increase the recuperation level on a slippery road surface.

Drive particularly carefully on slippery roads. Avoid sudden acceleration, steering and braking maneuvers.

Have your vehicle winterproofed at a qualified specialist workshop in time for the onset of winter.

Please observe the notes on snow chains (→ page 189).

Regularly check the vehicle and remove any snow and ice when traveling in wintry conditions.

Accumulations of snow and ice, particularly when frozen, in the area around the air intake, moving parts, the axles and the wheel housings may cause the following problems:

- obstruction of the air intake
- damage to vehicle parts
- malfunctions owing to restriction of movement intended by design (e.g. reduced steering movement)

If there is any damage, inform a qualified specialist workshop.

### Information about driving off road

**⚠ WARNING** Risk of accident if you do not keep to line of fall on inclines

If you drive at an angle or turn on an incline, the vehicle could slip sideways, tip and rollover.

- ▶ Always drive on inclines in the line of fall (straight up or down) and do not turn.

**▲ WARNING** Risk of injury from acceleration forces during off-road driving

You could be thrown from your seat, for example.

- ▶ Always wear your seat belt even when driving off-road.

**▲ WARNING** Risk of injury to the hands when driving over obstacles

If you drive over obstacles or in tire ruts, the steering wheel may whip around.

- ▶ The steering wheel must always be held securely with both hands.
- ▶ Always hold the steering wheel so that your thumbs are on the outer rim of the steering wheel.
- ▶ When driving over obstacles, expect increased steering forces at short notice.

**! NOTE** Damage to the vehicle after driving off-road

Foreign bodies, such as stones and branches, could become trapped on the vehicle underside or on wheels and tires while you are driving and cause damage to the vehicle.

Foreign bodies could cause the following damage:

- Damage to the suspension, the high-voltage battery on the vehicle underside or the brake system
- Cause imbalances and thus vibrations
- ▶ Regularly remove any trapped foreign bodies, e.g. stones and branches.
- ▶ After driving off-road, check carefully whether there is any damage to the vehicle.
- ▶ If there is damage, have the vehicle checked at a qualified specialist workshop.

When driving off-road or on unpaved surfaces, check the vehicle underside, wheels and tires at regular intervals. In particular, remove any trapped foreign bodies such as stones and branches.

Please observe the following notes regarding foreign bodies of this kind:

- They could damage the suspension, the high-voltage battery in the underbody or the brake system.
- They could cause imbalances and thus vibrations.
- They could be ejected from the vehicle when you continue driving.

If there is any damage, inform a qualified specialist workshop.

When driving off-road and on construction sites, e.g. sand, mud and water, also mixed with oil, can get into the brakes. This could lead to a reduction in braking effect or total brake failure, including as a result of increased wear. The braking characteristics vary depending on the material that has infiltrated the system. Clean the brakes after driving off-road. If you then notice a reduced braking effect or hear scraping noises, have the brake system checked immediately at a qualified specialist workshop. Adjust your driving style to the changed braking characteristics.

Driving off-road or on construction sites increases the possibility of vehicle damage, which could in turn lead to the failure of certain major assemblies or systems. Adapt your driving style to the off-road driving conditions. Drive carefully. Have any vehicle damage repaired at a qualified specialist workshop as soon as possible.

When driving on rough terrain, do not shift the transmission to neutral position. You could lose control when attempting to brake the vehicle with the service brake. If your vehicle cannot manage an uphill incline, drive back down in reverse gear.

When loading your vehicle for driving off-road or on a construction site, keep the vehicle center of gravity as low as possible.

**Check-list before driving off-road**

- **Vehicle tool kit:** check that the jack is working (→ page 203).
- Make sure that a lug wrench (→ page 203), a wooden underlay for the jack, a sturdy tow rope, a folding spade and a wheel chock (present, depending on equipment) are carried in the vehicle.
- **Tires and wheels:** Check the tire tread depth (→ page 188) and the tire pressure (→ page 193).

### Rules for off-road driving

Always be aware of the vehicle's ground clearance and avoid obstacles such as deep tire ruts.

Obstacles can damage the following parts of the vehicle, for example:

- suspension
- drivetrain
- the high-voltage battery in the underbody

Therefore, always drive slowly off-road. If you must drive over obstacles, have the front passenger guide you.

- **i** Mercedes-Benz recommends that you additionally carry a shovel and a recovery rope with a shackle in the vehicle.
- Make sure that loads and items of luggage are securely stowed or lashed down (→ page 162).
- If the surface requires, temporarily deactivate ESP® when starting off (→ page 122).
- Drive slowly and smoothly. It may often be necessary to drive at walking pace.
- Avoid spinning wheels.
- Ensure that the wheels remain in contact with the ground.
- As a precaution, get out of the vehicle to take a look at the route ahead. Exercise the utmost caution when driving across unfamiliar, unpredictable terrain.
- Look out for obstacles (e.g. rocks, holes, tree stumps and tire ruts).
- Avoid edges where the ground could crumble or break away.

### Check-list after driving off-road

Driving off-road places greater demands on your vehicle than normal road operation. Check your vehicle after driving in rough terrain. This allows you to detect damage promptly and reduce the risk of an accident for yourself and other road users. Clean your vehicle thoroughly before driving on public roads.

If you find damage to the vehicle after off-road driving, have the vehicle checked at a qualified specialist workshop immediately.

Please note the following points after driving off-road, on construction sites and before driving on public roads:

- Activate ESP® (→ page 122).
- Clean the exterior lighting, particularly the headlamps and tail lamps, and check them for damage.
- Clean the front and rear license plates.
- Clean the windshield, windows and outside mirrors.
- Clean the steps, entrances and grab handles. This will make your footing safer.
- Clean the wheels and tires, wheel wells and the underbody of the vehicle with a jet of water. This increases road adhesion, especially on wet road surfaces.
- Check the wheels and tires and wheel wells for trapped foreign objects and remove them. Trapped foreign objects can damage the wheels and tires or be ejected from the vehicle when you continue your journey.
- Check the underbody for trapped branches or other parts of plants and remove them.
- Clean the brake disks, brake pads and axial joints, particularly after operation in sand, mud, grit and gravel, water or similar conditions.
- Check the entire floor assembly, tires, wheels, bodywork structure, brakes, steering and suspension for damage.
- Check the service brake for operating safety, e.g. carry out a brake test.
- If you notice strong vibrations after driving off-road, check the wheels and drivetrain for foreign objects again. Remove any foreign objects that could lead to imbalances and thus cause vibrations. In the event of damage to the wheels and the drivetrain, visit a qualified specialist workshop immediately.

### Function of the ECO display

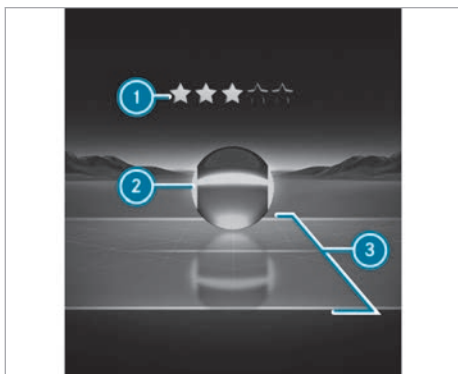

The ECO display shows an evaluation of your driving style on the instrument cluster display depending on the situation. This enables you to check the efficiency of your driving style and adjust it if necessary. The **ECO Display** menu shows a ball (2) that will roll forwards or backwards in the direction of travel on a stylised road according to the driving characteristics.

Above and below the road, lines mark the area for an efficient driving style (3). Ball (2) will light up in green if it is rolling within these lines. Outside the lines, the ball will light up in orange.

The ECO display assesses the following criteria for an economical driving style:

- Coasting at the right times
- Consistent speed
- Moderate acceleration

The overall assessment of your driving style "from start" is indicated using stars (1). It starts with five empty stars, which you can fill one after the other if you drive efficiently. When all five stars are filled, a glow will appear in the background.

**i** You can call up the **ECO Display** function via the **Trip** menu.

## Drive programs

### Function of the program selector button

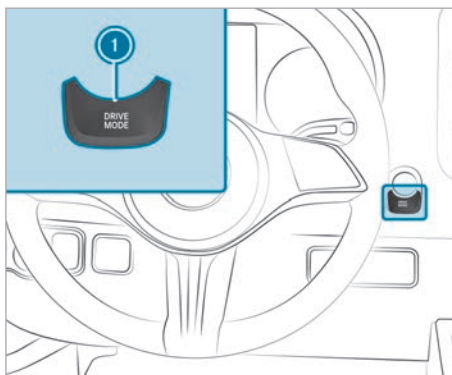

Use program selector button (1) to switch between the following drive programs:

- C** (Comfort)
- E** (Eco)
- MIR** (MAX Range)

Depending on the drive program selected, the following vehicle characteristics will change:

- The performance of heating or air conditioning
- Output of the drive system
- Acceleration

The available power of the drive system is shown on the instrument cluster display and can be reduced, e.g. when the high-voltage battery has a very low state of charge (→ page 146).

**Characteristics per drive program:**

| Drive program         | Vehicle characteristics  |
|-----------------------|--|
| <b>C</b> (Comfort)    | <ul style="list-style-type: none"> <li>• Comfortable driving style</li> <li>• Full heating and air conditioning output</li> <li>• Maximum power availability of the drive system</li> </ul>  |
| <b>E</b> (Eco)        | <ul style="list-style-type: none"> <li>• Efficient and economical driving style</li> <li>• Reduced heating and air conditioning output for increased range</li> <li>• Reduced power of the drive system</li> </ul>                     |
| <b>MR</b> (MAX Range) | <ul style="list-style-type: none"> <li>• Maximum range and consumption optimisation</li> <li>• Heavily reduced heating and air conditioning output</li> <li>• Reduced torque and severely reduced power of the drive system</li> </ul> |

- i** If you depress the accelerator pedal beyond the point of resistance (kickdown), the maximum power will also be available in drive programs **E** and **MR**.

**Selecting a drive program**

- ▶ Press the program selector button. The drive program selected will appear on the instrument cluster display next to the transmission position display.

Depending on the selected energy content of the high-voltage battery, the **E** or **C** drive program will be automatically selected after a drive system start.

**Transmission****DIRECT SELECT lever****Function of the DIRECT SELECT lever**

- ⚠ WARNING** Risk of accident and injury due to children left unattended in the vehicle

If you leave children unattended in the vehicle, they could, in particular:

- open doors, thereby endangering other persons or road users.
- get out and be struck by oncoming traffic.
- operate vehicle equipment and become trapped, for example.

In addition, the children could also set the vehicle in motion by, for example:

- releasing the parking brake.
  - changing the gearbox position.
  - starting the vehicle.
- ▶ Never leave children unattended in the vehicle.
  - ▶ When leaving the vehicle, always take the key with you and lock the vehicle.
  - ▶ Keep the key out of reach of children.

- ⚠ WARNING** Risk of accident and injury when the transmission position is not engaged

The current transmission position will be highlighted on the instrument cluster display.

If the selected transmission position is not highlighted, the vehicle may pull away in the wrong direction or roll away.

- ▶ After changing the transmission position, always check the transmission position display on the instrument cluster.

If the transmission position is not highlighted on the instrument cluster display even after a short time:

- ▶ Pay attention to the display messages.
- ▶ Pull away carefully and check the engaged transmission position.
- ▶ When parking, engage the parking brake and secure the vehicle against rolling away.

- ▶ Have the transmission checked immediately at a qualified specialist workshop.

You can use the DIRECT SELECT lever to switch the transmission position. The current transmission position will appear highlighted on the instrument cluster display (→ page 146).

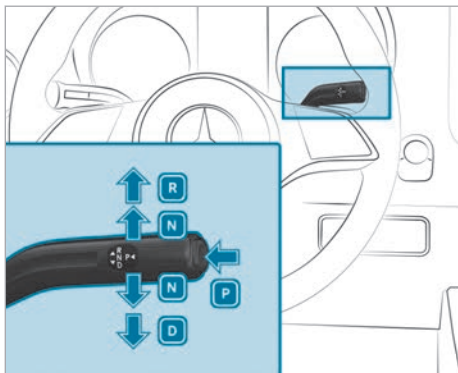

- P** Park position
- R** Reverse gear
- N** Neutral
- D** Drive position

### Selecting reverse gear R

- ▶ Depress the brake pedal and push the DIRECT SELECT lever upwards past the first point of resistance.

### Selecting neutral N

- ⚠ WARNING** Risk of accident and injury when neutral position is engaged

If you park the vehicle with the transmission in neutral position **N** and the parking brake is not engaged, the vehicle may roll away.

There is a risk of accident and injury.

- ▶ Before parking the vehicle, apply the parking brake.

- ▶ Press the brake pedal and the DIRECT SELECT lever upwards or downwards to the first point of resistance.

Subsequently releasing the brake pedal will allow you to move the vehicle freely, e.g. to push it or tow it away.

If the transmission is also to stay in neutral **N** when the vehicle is switched off, proceed as follows:

- ▶ Start the vehicle.
  - ▶ Depress the brake pedal and engage neutral **N**.
  - ▶ Release the brake pedal.
  - ▶ Switch off the vehicle.
- i** If you then exit the vehicle leaving the key in the vehicle, the transmission will remain in neutral **N**.

### Selecting park position P

- I NOTE** Damage due to engaging park position **P** while the vehicle is rolling

If you shift the transmission into park position **P** while the vehicle is rolling, the transmission may be damaged.

- ▶ If the vehicle is rolling, do not open a door.
- ▶ Only engage park position **P** when the vehicle is stationary.

- ▶ Observe the notes on parking the vehicle (→ page 116).
- ▶ Depress the brake pedal until the vehicle is stationary.
- ▶ When the vehicle is stationary, press button **P**.  
When the **P** transmission position is shown, park position is engaged. If the **P** transmission position is not shown, apply the parking brake. Secure the vehicle against rolling away with a wheel chock or a non-sharp-edged object.
- i** Depending on the situation, it may take a short time until transmission position **P** is engaged. Therefore, always pay attention to the transmission position indicator.

Park position **P** will be engaged automatically when one of the following conditions is met:

- You switch the stationary vehicle off in transmission position **D** or **R**.
- You open the fully closed driver's door when the vehicle is stationary in transmission position **D** or **R**.
- When the vehicle is rolling, you switch it off in transmission position **D** or **R** and bring it to a standstill.

- When the HOLD function is active or the Active Distance Assist DISTRONIC system is active (vehicle stationary), the driver leaves the seat or the driver's seat belt buckle is unfastened.
  - When the vehicle is rolling, you shift to transmission position **N**, bring the vehicle to a standstill and open the fully closed driver's door when the vehicle is stationary.
  - Engaging park position **P** automatically is required by the vehicle.
- i** To maneuver with an open driver's door, open the fully closed driver's door while the vehicle is stationary and engage transmission position **D** or **R** again.

### Selecting drive position D

- ▶ Depress the brake pedal and push the DIRECT SELECT lever downwards past the first point of resistance.

## Charging the high-voltage battery

### Notes on charging the high-voltage battery

- !** **NOTE** High-voltage battery damage due to leaving the vehicle idle for lengthy periods of time

Lithium-ion batteries experience a natural self-discharge.

Exhaustive discharging can therefore occur if the vehicle is idle for several months. This can damage the high-voltage battery.

- ▶ To avoid damage, please observe the following recommendations when handling the high-voltage battery.

- !** **NOTE** Accelerated aging of the high-voltage battery may occur if the following recommendations are not observed.

As a result of its basic characteristics, the storage capacity of and the amount of energy available from the high-voltage battery decreases over the course of its life. Therefore, both the maximum electrical range that can be achieved by the vehicle and its maximum electrical output can be impaired.

The following factors can accelerate the aging of the high-voltage battery:

- Frequent rapid charging with direct current (mode 4)
  - Leaving the vehicle non-operational for long periods at high ambient temperatures
- ▶ To avoid accelerated aging, please observe the following recommendations when handling the high-voltage battery.

- !** **NOTE** Damage to the vehicle socket or the charging cable connector due to incorrect handling

Do not use excessive force (maximum 67.4 lbf (300 N)) to fully insert the charging cable connector into the vehicle socket. You may otherwise damage the vehicle socket, the charging cable connector or their contacts.

- ▶ If you feel there is increased resistance, pull the charging cable connector out of the socket and reinsert it.

- !** **NOTE** Damage to the drive system when charging the high-voltage battery at extreme elevations

The drive system may be damaged if the high-voltage battery is charged at elevations greater than 13,123.36 ft (4,000 m) above sea level.

It may then no longer be possible to continue the journey.

- ▶ Avoid charging processes at extreme elevations.

Information on charging times can be found in the technical data (→ page 246).

Recommendations when handling the high-voltage battery:

- Only use direct current (mode 4) to quick-charge the high-voltage battery if necessary.
- The high-voltage battery should always be charged to a state of charge of 100 %.
- If leaving the vehicle idle for extended periods, park it with a high-voltage battery state of charge of between 30% and 50%. Do not keep the high-voltage battery continuously connected to power supply equipment.
- If leaving the vehicle idle for extended periods, avoid high ambient temperatures, if possible.

- Check the high-voltage battery's state of charge every six weeks (→ page 108).
- If the state of charge is below 20%, recharge the high-voltage battery.
- Do not disconnect the 12 V battery even if the vehicle is left idle for an extended period. Otherwise the condition of the vehicle's high-voltage battery will not be monitored.

You can contribute to reducing the vehicle's energy consumption in the following ways:

- an anticipatory driving style (→ page 103)
- reduced use of electrical consumers
- having the vehicle regularly serviced

The charging time of the high-voltage battery may change over the course of its life.

You can charge the high-voltage battery with both alternating current (mode 2 or 3) and direct current (mode 4).

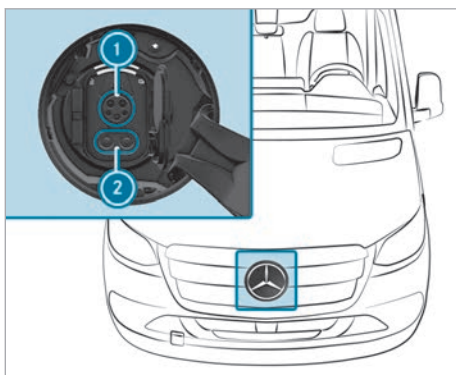

Vehicle socket in the radiator shell

- ① Socket for AC charging
- ② Socket extension for DC charging
- ⓘ When using a CCS (Combined Charging System) charging cable to charge with direct current, both sections of the vehicle socket are covered by the charging cable plug.

Charging options for the high-voltage battery:

- Charging through recuperation while the vehicle is in motion
- Stationary charging with alternating current via:
  - mains socket (mode 2)
  - wallbox (mode 3)
  - charging station (mode 3)
- Stationary charging with direct current via:
  - charging station (mode 4)

The charging current for single phase charging is determined by the country-specific equipment installed in the vehicle.

Observe any possible different local mains requirements at your current location when charging.

Consult a qualified electrician or your local distribution network operator if you have any questions concerning mains requirements.

It is recommended that you charge the high-voltage battery at a wallbox or charging station owing to the improved charging power and better charging efficiency offered.

### System limits

The charging time of the high-voltage battery may be increased by the following:

- high or low outside temperatures
- the vehicle remaining idle for an extended period without charge
- the maximum available charging current of the wallbox or power supply
- the settings for the charging process in the on-board computer
- you have consented to a calibration of the high-voltage battery (→ page 166)

The power output of the high-voltage battery may be impaired by the following:

- high or low outside temperatures
- electrical auxiliary consumers in the vehicle being switched on, e.g. running the climate control system
- the vehicle remaining idle for an extended period without charge

### Function of the charge level display

- ⓘ The data shown in the illustration are sample data.

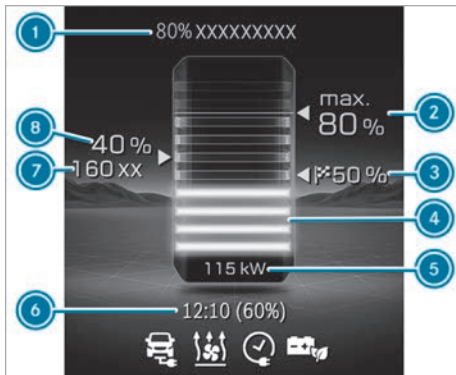

- ① Time remaining until fully charged (until the selected maximum state of charge is reached)
- ② Maximum state of charge (depending on the setting)
- ③ State of charge recommended by Range Assistant to reach the next destination
- ④ Dynamic charge level display
- ⑤ Current charging capacity
- ⑥ State of charge at next set departure time
- ⑦ Remaining range at current state of charge
- ⑧ Current state of charge of the high-voltage battery
- Set "Standard" charging program
- Pre-entry climate control active (automatic if departure time is set)
- Departure time symbol: one-time departure time set
- ECO charging activated

- ⓘ Indicated remaining range ⑦ may vary due to different factors, e.g. driving style or topography.
- ⓘ The value of the current charging capacity ⑤ can differ from the display on the charging station. At a charging capacity of 10 kW or higher, the value in the charge level display is rounded off and shown without a decimal place.

The value in ① varies depending on the setting of the charging process. It displays a prediction for the time until the maximum state of charge is reached. If Range Assistant is active, it displays a prediction for the time until the continuation of the journey is recommended.

The value in ⑥ varies depending on the setting of the charging process. It displays the expected

state of charge at the next set departure time. This may be a single event or the next element in the weekly profile.

In addition to the symbol for the "Standard" charging program, the following symbols may also be displayed:

- The Home charging program is set.
- The Work charging program is set.

ⓘ An orange plug symbolizes a charging prompt. In addition to the symbol for the "One-time departure time" setting, the following symbols may also be displayed:

- No departure time is set.
- The weekly profile is active.

### Configuring the charging settings

On-board computer:

➔ Settings ➔ eSprinter

In the case of fleet vehicles, the eSprinter menu or its menu items may not be available.

- ▶ Adjust the settings in the fleet management system, if possible.

### Setting the charging program

- ▶ Select **Standard**, **Home** or **Work**.

### Setting the maximum state of charge

You can set the maximum state of charge in increments of 10% between 50% and 100%.

- ▶ Observe the notes on charging the high-voltage battery (→ page 107).
- ▶ Select **Standard**, **Home** or **Work**.
- ▶ Set the maximum state of charge to the desired value, for example 80%.

ⓘ For the high-voltage battery used in this vehicle, we advise against continually limiting the maximum state of charge, but recommend instead charging the high-voltage battery fully at regular intervals.

### Unlocking the charging cable (mode 3 or 4)

- ⓘ When the function is active, the charging cable is unlocked once the maximum state of charge is reached.
- ▶ Select **Home** or **Work**.
- ▶ Activate or deactivate **Unlock Charging Cable**.

### Switching on or off ECO Charging ICON\_Eco\_Charging\_small

- ▶ Select **Standard**, **Home** or **Work**.
- ▶ Activate or deactivate the function.

The **ECO Charging** **ICON\_Eco\_Charging\_small** function reduces the strain placed on the high-voltage battery during the charging process, thereby helping to slow the natural aging process. The vehicle is charged using alternating current (AC) to a defined state of charge. It then takes the departure time into account when determining the rest of the charging process. This ensures that the high-voltage battery is optimally charged and still reaches the desired state of charge.

#### Setting the departure time

The set departure times are used for the vehicle's pre-entry climate control system and to predict the state of charge at the time selected.

As long as **ECO Charging** **ICON\_Eco\_Charging\_small** is not activated, the charging process always starts immediately, irrespective of the next departure time.

- ① If the Range Assistant function is active, it automatically determines, during a charging stop, the approximate time by which the desired state of charge will be reached. This will be used as an approximate departure time for pre-entry climate control and will be set automatically. Previously set departure times cannot be changed when the function is active.

- ▶ Select **Departure Time**.

The following charging times can be set:

- Individual charging times
- A **Week Profile** **ICON\_DepartureTimeWeekly**

#### Setting an individual departure time

- ▶ Select **Add New Time** and set a new departure time.

or

- ▶ Select  and adjust an existing departure time.

#### Setting the repeat days

- ▶ Set the weekly profile via "Mercedes me connect".

Further information may be found in the "Mercedes me connect" Supplement.

### Functions of the indicator lamps on the vehicle socket

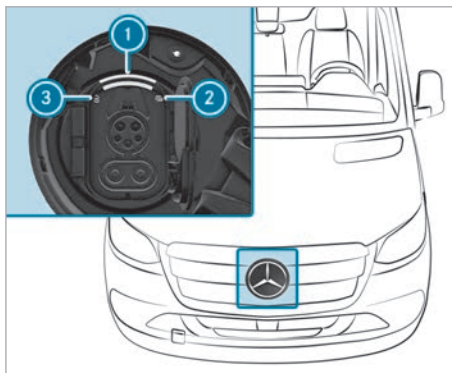

The charge socket flap with the Mercedes star in the radiator grill is centrally locked and unlocked together with the vehicle.





- ① Status indicator
- ② Charging process indicator lamp
- ③ Locking status indicator lamp





Status display ① flashes or lights up in sync with indicator lamps ② and ③.

#### Overview of locking status

| Locking status ③  | Display         | Meaning  |
|---|-----------------|--|
|  | Lights up white | Vehicle socket unlocked, insert or remove charging cable |
|  | Flashes white   | Malfunction during locking or unlocking                  |

#### Overview of the charging process status

| Status of charging process ②  | Display        | Meaning                         |
|---|----------------|---------------------------------|
|  | Flashes orange | Connection is being established |
|  | Flashes green  | Active energy flow              |

| Status of charging process  | Display                        | Meaning                   |
|--|--------------------------------|---------------------------|
|                             | Lights up orange               | Charging pause            |
|                             | Lights up green                | Charging process complete |
|                             | Flashes red (for approx. 90 s) | Malfunction when charging |

### Notes on charging the high-voltage battery at a mains socket (mode 2)

**⚠ DANGER** Risk of fatal injury from incorrectly installed component parts

Connecting the charging cable to a mains socket using incorrectly installed components could cause fires or an electrical shock, for example.

- ▶ Only connect the charging cable to a mains socket that:
  - has been properly installed and
  - has been inspected by a qualified electrician.
- ▶ For safety reasons, only use the charging cable supplied with the vehicle or an original Mercedes-Benz charging cable.
- ▶ Purchase these parts at a Mercedes-Benz service center and obtain advice there.

Mercedes-Benz thoroughly tests these original charging cables for their suitability for high-voltage charging of your vehicle.

- ▶ Never use a damaged charging cable.
- ▶ Do not use:
  - Extension cables
  - Extension reels
  - Multiple sockets
- ▶ Only use a socket adapter that has been tested and approved by the manufacturer for charging the high-voltage battery in an electric vehicle. Never use several socket adapters. For charging at

the mains socket, only use appropriate socket adapters for AC charging.

- ▶ Observe the safety notes in the Operator's Manual for the socket adapter.

**!** **NOTE** Overloading the mains socket due to excessive charging current

If the charging current is too high, the fuse could be tripped or the external mains supply could overheat.

- ▶ Make sure that the external mains supply has been designed for the charging current on the vehicle side.
- ▶ Use a different, suitable mains socket.

Before charging at a mains socket, have the maximum permissible charging current for the relevant mains socket or the building installation inspected by a qualified electrician.

The charging cable can be set to a country-specific maximum charging current value. When charging abroad, the maximum value may exceed the permitted value for that country.

When abroad, observe the country-specific regulations when charging.

Only use charging cables which meet the local mains requirements at your location and are approved for your vehicle.

If you have questions concerning charging cables or if there is a malfunction, please contact a qualified specialist workshop.

The charging process can vary depending on the power supply equipment.

Short charging times are achieved in the following ways:

- by charging at a wallbox
- by charging at a charging station

When doing so, always observe the local information.

### Notes on charging the high-voltage battery at a wallbox (mode 3)

**⚠ DANGER** Risk of fatal injury from incorrectly installed component parts

Connecting the charging cable to a wallbox using incorrectly installed components could cause fires or an electrical shock, for example.

- ▶ Only connect the charging cable to a wallbox that:
  - has been properly installed and
  - has been inspected by a qualified electrician.
- ▶ For safety reasons, only use charging cables that have been tested and approved by the manufacturer for charging the high-voltage battery in an electric vehicle.
- ▶ Never use damaged charging cables.
- ▶ Do not extend the charging cable.
- ▶ Only use a socket adapter that has been tested and approved by the manufacturer for charging the high-voltage battery in an electric vehicle. Never use several socket adapters. Only use socket adapters suitable for AC charging when charging with alternating current at a wallbox or charging station.
- ▶ Observe the safety notes in the Operator's Manual for the wallbox.

Observe the local mains requirements at your current location when charging. When charging at a wallbox without a pre-installed cable, only use approved charging cables which conform to these mains requirements. Consult a qualified electrician or your local distribution network operator if you have any questions concerning mains requirements.

#### Notes on charging the high-voltage battery at a charging station (mode 3/4)

**⚠ DANGER** Risk of fatal injury if damaged component parts are used

If you use a damaged component to connect the vehicle to a charging station, this may lead to fires or an electrical shock, for example.

- ▶ Visually inspect the charging station for obvious signs of damage, e.g. serious damage to the housing or charging cable connection.
- ▶ Never use damaged charging cables.
- ▶ Do not extend the charging cable.
- ▶ Only use a socket adapter that has been tested and approved by the manufacturer for charging the high-voltage battery in an electric vehicle. Never use several

socket adapters. When charging at a charging station with alternating current (mode 3), only use the corresponding socket adapters for charging with alternating current and when charging at a fast charging station with direct current (mode 4), only use socket adapters for direct current charging.

- ▶ Be sure to observe the safety notes at the charging station.

**⚠ DANGER** Risk of fatal injuries when carrying out maintenance work during the charging process

During the charging process, the high-voltage on-board electrical system is under high voltage.

- ▶ Do not perform any maintenance work during the charging process.

Observe the local mains requirements at your current location when charging. When charging with alternating current at a charging station without a pre-installed cable, only use approved charging cables which conform to these mains requirements. Consult a qualified electrician or your local distribution network operator if you have any questions concerning mains requirements.

Most charging stations need to be activated before the charging process, e.g. by using an RFID card or via Plug-and-Charge. Observe the local operator's instructions for the charging station and the notes on Mercedes me Charge (see the Digital Operator's Manual for the vehicle).

Due to legal regulations in the individual countries, the charging cable to the vehicle must be no longer than 98.5 ft (30 m). This is to prevent the interference of signals being received by radio communication devices in the vehicle or in close proximity to the charging station. Be aware that parts of the charging cable may be routed underground. If in doubt, ask the charging station operator if this is the case before charging the high-voltage battery.

#### Starting the charging process

**⚠ DANGER** Risk of death when charging at a damaged socket

The charging process uses high voltage.

If the charging cable, the vehicle socket or the mains socket are damaged, you could receive an electric shock.

- ▶ Only use an undamaged charging cable.
- ▶ Avoid mechanical damage such as crushing, abrading or driving over the cable.
- ▶ Have a damaged vehicle socket replaced at a qualified specialist workshop as soon as possible.
- ▶ Never connect the charging cable to a damaged vehicle socket.

**!** **NOTE** Damage to the vehicle due to overvoltage in the mains supply

The vehicle is equipped with an electrical fuse which protects it against overvoltage in the mains supply. This electrical fuse may trip during severe thunderstorms, for example, and may cause the fuse in the building to trip or may interrupt the charging process. These functions protect the vehicle.

After the fuse in the building is switched on again, the charging process resumes automatically.

Following an interruption in the power supply without the fuse in the building being tripped, it may take up to ten minutes for charging to resume automatically.

**!** **NOTE** Damage due to overheating of charging cable and charge port

Charging cable and charge port may generate heat within the permissible limiting values during the charging process.

The heat generated by the charging cable and charge port is influenced by the following factors:

- The power supply of the mains and the charging cable are intact.
- The notes on handling the charging cable and operating unit on the charging cable were observed.
- ▶ If the charging cable or the charge port generate too much heat, have the power supply of the mains supply checked.

**!** **NOTE** Damage to the vehicle socket or the charging cable connector due to incorrect handling

Do not use excessive force (maximum 67.4 lbf (300 N)) to fully insert the charging cable connector into the vehicle socket. You may otherwise damage the vehicle socket, the charging cable connector or their contacts.

- ▶ If you feel there is increased resistance, pull the charging cable connector out of the socket and reinsert it.



**!** **NOTE** Damaged or dirty vehicle socket when the socket flap is open

- ▶ Always keep the socket cover and the socket flap closed when there is no charging cable connected. This protects the vehicle socket from dirt and damage.
- ▶ Make sure that the socket cover is closed properly before closing the socket flap. This can otherwise result in damage which may prevent the socket flap from being opened again.

#### Requirements:

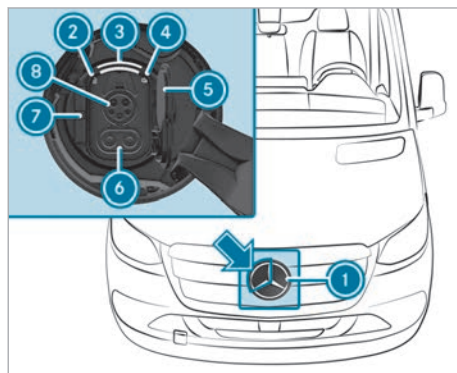
- The transmission is in position **P**.
- The vehicle has not been started.
- The vehicle is unlocked, or the distance of the key to the vehicle socket is no greater than 3 ft (1 m). In addition, the battery of the key must be sufficiently charged.
- The hood is closed (only applies to mode 4).
- The charging cable is not in tension.



- ▶ Press the top left of the socket flap ① for up to one second until it opens. Socket flap ① opens slightly. If the vehicle is not unlocked, the socket flap opens after a brief delay.
  - The  indicator lamp ② and status display ③ light up white.
- ▶ Open socket flap ① completely.
- ① If the drive system has been started (display  is lit in the instrument cluster), socket flap ① cannot be opened.
- ▶ To charge with alternating current, press the upper catch, and to charge with direct current, press both catches ⑦ to the left. The respective socket cover ⑤ is opened.
- ① For the charging process with alternating current (mode 2 or 3), only port ⑧ is required.

#### Charging via mains socket (mode 2):

- ▶ Insert the mains plug into the mains socket of the external power source to the stop.
- ▶ Insert the charging cable plug into port ⑧ of the vehicle socket. Port ⑥ remains free and should remain covered by the lower part of socket cover ⑤.
  - The indicator lamp ④  and status display ③ initially flash orange, and then green as soon as the high-voltage battery is being charged.

#### Charging at a wallbox or charging station (mode 3)

- ▶ Insert the charging cable plug into port ⑧ of the vehicle socket. Port ⑥ remains free and should remain covered by the lower part of socket cover ⑤. If the wallbox or charging station is not equipped with a connecting cable, insert the plug of the optional charging cable into the wallbox or charging station socket to the stop.
  - The indicator lamp ④  and status display ③ initially flash orange, and then green as soon as the high-voltage battery is being charged.

#### Charging at a charging station (mode 4):

- ▶ Insert the CCS charging cable plug into the vehicle socket to the stop.
  - The indicator lamp ④  and status display ③ initially flash orange, and then green as soon as the high-voltage battery is being charged.

When the charging cable is connected to the vehicle, the drive system cannot be started and the vehicle cannot be moved.

The charging process is aborted if the hood is opened during this process (only applies to mode 4).

When the charging process is started, the estimated charging time is displayed in the instrument cluster. The charging prediction shows the predicted state of charge at the set departure time or the time at which the high-voltage battery will be fully charged.

The charging prediction may display the following information:

- the predicted state of charge at a set departure time
- the time at which the high-voltage battery will be fully charged
- the time at which the high-voltage battery will reach the preset maximum state of charge

Observe any information displayed in the instrument cluster:

- Charging prediction (→ page 108)
- Display messages (→ page 251)
- ① Depending on the temperature, the fan and battery cooling system may audibly switch on during the charging process.
- ① If the vehicle is connected to the alternating current mains supply (mode 2 or 3), the high-voltage battery will be recharged automatically as needed or when electrical consumers such as, e.g. pre-entry climate control, are activated.



## Ending the charging process

### Requirements:

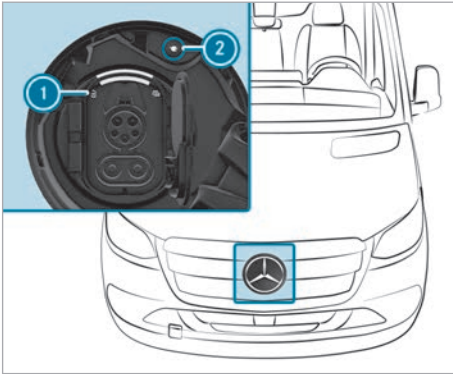
- The distance of the key to the vehicle socket is no greater than 3 ft (1 m) or the vehicle is unlocked.



▶ Press charging interruption button ②. The charging process is ended after a short time. If the indicator lamp  ① then lights up white, the vehicle socket is unlocked.

① Only when the charging interruption button ② is inoperative can you alternatively unlock the vehicle with the vehicle key in order to end the charging process. To do this, press the  button on the key four times within two seconds. If the indicator lamp  ① then lights up white, the vehicle socket is unlocked for approximately 30 seconds.

▶ Remove the charging cable plug from the vehicle socket.

① If you cannot remove the charging cable plug, repeat the unlocking procedure. If the charging cable plug remains locked, unlock the charging cable connector with the emergency release (→ page 115).

▶ Close it, or close the socket cover and the socket flap.

▶ Remove the charging cable from the mains socket, or from the socket on the wall-box/charging station, and stow the vehicle's charging cable safely in the vehicle.

① After the charging cable plug has been disconnected, the indicator lamp  ① on the vehicle socket remains lit for some time before going out.

## Unlocking the charging cable plug with the emergency release

**⚠ WARNING** Risk of burns from hot components in the engine compartment

Certain components in the engine compartment can be very hot, e.g. the drive system and the cooler.

▶ Allow the drive system to cool down and touch only the components described below.

If you need to release the charging cable plug manually, only touch the following components:

- Hood
- Emergency release cable

**! NOTE** Damaged or dirty vehicle socket when the socket flap is open

▶ Always keep the socket cover and the socket flap closed when there is no charging cable connected. This protects the vehicle socket from dirt and damage.

▶ Make sure that the socket cover is closed properly before closing the socket flap. This can otherwise result in damage which may prevent the socket flap from being opened again.

### Requirements:

- The charging cable plug cannot be disconnected.
- The distance of the key to the vehicle socket is no greater than 3 ft (1 m) or the vehicle is unlocked.

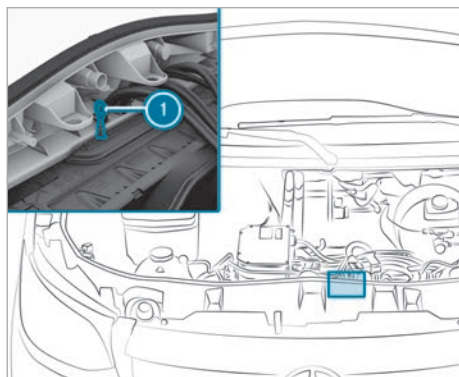

▶ Open the hood (→ page 169).

- ▶ Press the charging interruption button on the vehicle socket (→ page 115) and check the indicator lamps to see if the charging process has ended (→ page 110).
- ▶ Pull cable ① up and disconnect the charging cable plug from the vehicle socket within 30 seconds.
- ▶ Close the socket cover and the charge socket flap of the vehicle socket.
- ▶ Have the vehicle socket checked at a qualified specialist workshop.

## Parking

### Parking the vehicle

**⚠ WARNING** Risk of accident and injury due to children left unattended in the vehicle

If you leave children unattended in the vehicle, they could, in particular:

- open doors, thereby endangering other persons or road users.
- get out and be struck by oncoming traffic.
- operate vehicle equipment and become trapped, for example.

In addition, the children could also set the vehicle in motion by, for example:

- releasing the parking brake.
- changing the gearbox position.
- starting the vehicle.

- ▶ Never leave children unattended in the vehicle.
- ▶ When leaving the vehicle, always take the key with you and lock the vehicle.
- ▶ Keep the key out of reach of children.

**⚠ WARNING** Risk of accident and injury caused by an insufficiently secured vehicle rolling away

If the vehicle is not securely parked sufficiently, it can roll away in an uncontrolled way even at a slight downhill gradient.

- ▶ On uphill or downhill gradients, turn the front wheels so that the vehicle rolls towards the curb if it starts moving.
- ▶ Apply the parking brake.
- ▶ Switch the transmission to position **P**.

**!** **NOTE** Damage to the vehicle or the drivetrain due to rolling away

- ▶ Always park your vehicle safely and according to legal requirements.
- ▶ Always properly secure the vehicle against rolling away.

**⚠ WARNING** Risk of accident and injury if the parking brake is not applied.

The vehicle can roll away if the parking brake is not applied and you park the vehicle with the park position **P** engaged.

The engaged park position **P** is not a full substitute for the parking brake.

There is a risk of accident and injury.

- ▶ Secure the vehicle against rolling away as described below.

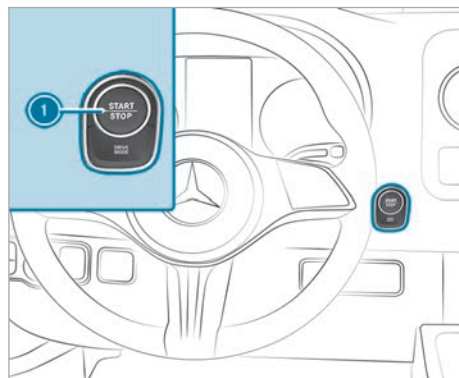

To correctly secure the vehicle against accidentally rolling away, observe the following points.

- ▶ Always apply the parking brake.
- ▶ **On gradients:** turn the front wheels towards the curb.
- ▶ Shift the transmission to position **P**.
- ▶ Switch off the vehicle by pressing button ①.
- ▶ Get out of the vehicle and lock it.
- ▶ **On gradients:** secure the wheels on the rear axle with a chock or an object without any sharp edges .

## Electric parking brake

### Information on the electric parking brake

**⚠ WARNING** Risk of accident and injury due to children left unattended in the vehicle

If you leave children unattended in the vehicle, they could, in particular:

- open doors, thereby endangering other persons or road users.
- get out and be struck by oncoming traffic.
- operate vehicle equipment and become trapped, for example.

In addition, the children could also set the vehicle in motion by, for example:

- releasing the parking brake.
- changing the gearbox position.
- starting the vehicle.

▶ Never leave children unattended in the vehicle.

▶ When leaving the vehicle, always take the key with you and lock the vehicle.

▶ Keep the key out of reach of children.



Observe the note on animals in the vehicle (→ page 31).

For the automatic functions to work correctly, the driver must be seated in the correct seat position (→ page 57).

The function of the electric parking brake is dependent on the on-board electrical system voltage. If the on-board electrical system voltage is low or there is a malfunction in the system, the electric parking brake may not be able to be applied. In this case, the yellow indicator lamp  lights up.

In this case, park the vehicle in the following way:

- Park the vehicle on level ground and secure it to prevent it from rolling away.
- Shift the transmission to position .

**i** The electric parking brake is only actually applied when the red indicator lamps  and  (USA) or the red indicator lamp  (Canada) light up continuously.

It may not be possible to release a parking brake if the on-board electrical system voltage is low or if there is a malfunction in the system. Inform a qualified specialist workshop.

When the vehicle is stationary, the electric parking brake carries out a function test at regular intervals. Noises are normal in this process.

The automatic application of the parking brake only works after a previous journey.

### Function of the electric parking brake

When the vehicle is switched off after a journey and the transmission is in position , the electric parking brake is automatically applied.





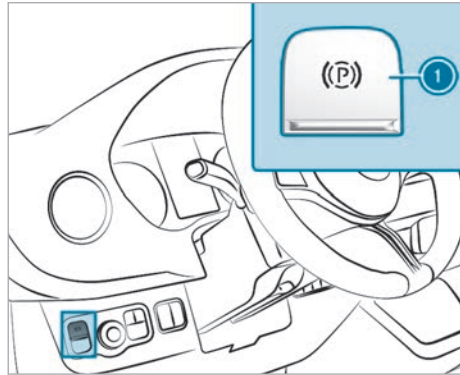

In addition, at least one of the following conditions must be fulfilled:

- The driver is not sitting in the driver's seat.
- The seat belt buckle is undone.



The electric parking brake is also applied when the transmission is not in position , but the following situations occur:

- There is a system malfunction.
- The power supply is insufficient.
- The vehicle has been stationary for a longer time.

The red  and  (USA) or  (Canada) indicator lamps in the instrument cluster light up. The electric parking brake is only actually applied when the red  and  (USA) or  (Canada) indicator lamps light up continuously.

**i** To prevent the electric parking brake from applying automatically, pull switch **1**.

### Releasing the electric parking brake automatically

The electric parking brake of your vehicle is released when all of the following conditions are fulfilled:

- The driver is sitting in the driver's seat.
- The driver is belted.
- The vehicle has been started.
- Transmission position **D** or **R** is engaged and you depress the accelerator pedal.

or

You shift from transmission position **P** to transmission position **D** or **R**. You must depress the accelerator pedal for good measure when driving on steep uphill gradients.

- If transmission position **R** is engaged, the rear-end doors must be closed.

### Applying/releasing the electric parking brake manually

**⚠ WARNING** Risk of accident and injury due to children left unattended in the vehicle

If you leave children unattended in the vehicle, they could, in particular:

- open doors, thereby endangering other persons or road users.
- get out and be struck by oncoming traffic.
- operate vehicle equipment and become trapped, for example.

In addition, the children could also set the vehicle in motion by, for example:

- releasing the parking brake.
- changing the gearbox position.
- starting the vehicle.

▶ Never leave children unattended in the vehicle.

▶ When leaving the vehicle, always take the key with you and lock the vehicle.

▶ Keep the key out of reach of children.

- Observe the "Notes on pets in the vehicle" (→ page 31).
- ▶ **To apply:** press switch **(P)** when the vehicle is stationary.  
When the electric parking brake is applied, the red indicator lamps **PARK** and **(P)** (USA) or **(P)** (Canada) light up in the instrument

cluster. The electric parking brake is only actually applied when the red indicator lamps **PARK** and **(P)** (USA) or **(P)** (Canada) light up continuously.

It is also possible to apply the electric parking brake when the vehicle is switched off.

- ▶ **To release:** pull the **(P)** switch. The red indicator lamps **PARK** and **(P)** (USA) or **(P)** (Canada) in the instrument cluster go out.

You can only release the electric parking brake if the vehicle is switched on with the start/stop button.

### Emergency braking

In the event of an emergency, you can brake the vehicle while it is in motion with the electric parking brake.

- ▶ While driving, press switch **(P)** of the electric parking brake.

The vehicle is braked as long as you keep switch **(P)** of the electric parking brake depressed.

The vehicle's brake lights light up.

The longer switch **(P)** for the electric parking brake is depressed, the greater the braking force.

During the braking procedure, you will receive the following feedback from the vehicle:

- A warning tone will sound.
- The **Release Parking Brake** message appears in the instrument cluster.
- The red indicator lamps **PARK** and **(P)** (USA) flash or the red indicator lamp **(P)** (Canada) flashes in the instrument cluster.

When the vehicle has been braked to a standstill, the electric parking brake is applied.

### Parking up the vehicle

#### Measures for the 12 V on-board electrical system battery if the vehicle is standing idle for lengthy periods

- ▶ Seek advice from a qualified specialist workshop to avoid damage to the 12 V on-board electrical system battery due to deep discharge.
- ▶ If the 12 V onboard battery was disconnected and is reconnected, fully charge the high-voltage battery. This enables an optimal display

of the range and an optimal charging time forecast.

### Measures for the high-voltage battery if the vehicle is standing idle for lengthy periods

- ▶ Park the vehicle with the high-voltage battery at a state of charge between 30% and 50%.
- ▶ Do not keep the high-voltage battery continuously connected to power supply equipment.
- ▶ Check the state of charge of the high-voltage battery every two to three months. If the 12 V power supply is switched on, you can check the state of charge of the high-voltage battery with the on-board computer.
- ▶ If the charge level is insufficient, recharge the high-voltage battery (→ page 107).

**i** The on-board computer displays the charge level of the high-voltage battery in the instrument cluster display (→ page 146).

### Using the chock

Use the chock to provide additional safety to prevent the vehicle from rolling away, e.g. when parking or changing a wheel.

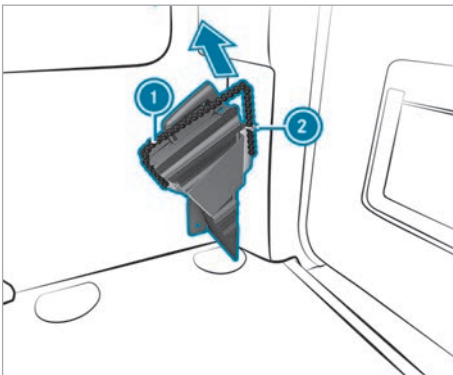

Chock in load/passenger compartment

- ▶ **To remove the chock:** pull holding rope **1** slightly downwards and then remove it from holder **2**.
  - ▶ Remove the chock.
- i** When stowing it away, ensure that the chock is secured in the holder by holding rope **1**.

## Driving and driving safety systems

### Notes on driving systems and your responsibility

Your vehicle is equipped with driving systems that assist you in driving, parking and maneuvering the vehicle. The driving systems are only aids. They are not a substitute for you paying attention to your surroundings and do not relieve you of your responsibility pertaining to road traffic law. The driver is always responsible for maintaining a safe distance to the vehicle in front, for vehicle speed, for braking in good time and for staying in lane. Always pay attention to the traffic and intervene if necessary. Be aware of the limitations regarding the safe use of these systems.

Driving systems can neither reduce the risk of accident if you fail to adapt your driving style nor override the laws of physics. They cannot always take into account road, weather or traffic conditions.

**i** Some driving systems can regulate or limit the speed to a previously set value. If there is a change of drivers, make sure that you inform the new driver about the set cruise speed.

### Information on vehicle sensors and cameras

Some driving systems and driving safety systems use cameras and radar or ultrasonic sensors to monitor the area in front of, behind or next to the vehicle.

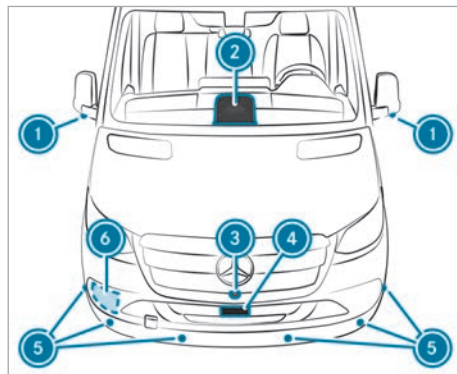

Front view (example)

- 1** Cameras in the outside mirrors
- 2** Multifunction camera
- 3** Front camera
- 4** Front radar

- ⑤ Ultrasonic sensors
- ⑥ Front radar for Sideguard Assist on front passenger side

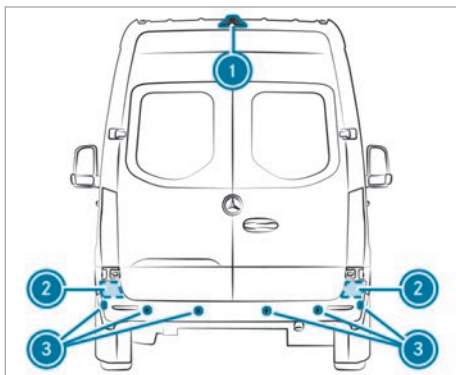

Rear view (example)

- ① Rear view camera
- ② Rear radar
- ③ Ultrasonic sensors

**⚠ WARNING** Risk of accident if the detection capability of the vehicle sensors or cameras is impaired

If the areas of the vehicle sensors or cameras are obscured, damaged or dirty, some driving and driving safety systems may no longer function correctly. There is a risk of an accident.

- ▶ Always keep the areas of the vehicle sensors and cameras clear of obstructions and clean.
- ▶ Have damage to the bumpers, radiator shell or stone chipping in the area of the cameras in the windshield repaired at a qualified specialist workshop.

Keep the areas of the cameras and sensors in particular free of dirt, ice and slush (→ page 173). The sensors and cameras must not be covered, and the detection ranges around them must be kept free. Do not attach additional license plate brackets, advertisements, stickers, wraps or stone chip protection films in the detection range of the sensors and cameras. Make sure that there are no overhanging loads protruding into the detection range.

In the event of damage, or following a severe impact, have the function of the sensors checked at a qualified specialist workshop. Have damage or

stone chips in the area of the cameras repaired at a qualified specialist workshop.

### Overview of driving systems and driving safety systems

In this section, you will find information about the following driving systems and driving safety systems:

- ABS (Anti-lock Braking System) (→ page 120)
  - BAS (Brake Assist System) (→ page 121)
  - ASR (Anti-Slip Control) (→ page 121)
  - EBD (Electronic Brakeforce Distribution) (→ page 122)
  - ESP® (Electronic Stability Program) (→ page 121)
  - ESP® Crosswind Assist (→ page 122)
  - ESP® Trailer Stability Assist (→ page 122)
  - Active Brake Assist (→ page 123)
  - Hill Start Assist (→ page 129)
  - HOLD function (→ page 129)
  - Cruise control (→ page 125)
  - Active Distance Assist DISTRONIC (→ page 126)
  - Active Lane Keeping Assist (→ page 136)
  - Blind Spot Assist (→ page 132)
  - Sideguard Assist (→ page 133)
  - Moving-off Information Assist (→ page 135)
  - ATTENTION ASSIST (→ page 131)
  - Rear view camera with rear-view mirror display (→ page 130)
- ④ The availability of individual functions depends on country and equipment.

### Functions of ABS (anti-lock braking system)

Observe the important safety guidelines for the driving safety system.

ABS controls the brake pressure in critical situations:

- During braking, for instance, at maximum full-stop braking or if there is insufficient tire traction, the wheels are prevented from locking.
- The steerability of the vehicle in terms of physical possibilities is ensured when you are braking.
- ABS is active at speeds above approximately 3 mph (5 km/h). On a slippery road surface, ABS will intervene even if you brake only gently.

#### System limits

ABS may be impaired or may not function if a malfunction has occurred and the yellow  ABS warning lamp lights up continuously on the instrument cluster after the vehicle is started.

If ABS intervenes, you will feel pulsations in the brake pedal. The pulsating brake pedal may be an indication of hazardous road conditions and functions as a reminder to take extra care while driving.

**If ABS intervenes:** keep the brake pedal firmly depressed until the braking situation has passed.

**To carry out maximum full-stop braking:** fully depress the brake pedal.

#### Function of BAS (Brake Assist System)

**▲ WARNING** Risk of an accident caused by a malfunction in BAS (Brake Assist System)

If BAS is malfunctioning, the braking distance in an emergency braking situation is increased.

▶ Depress the brake pedal with full force in emergency braking situations. ABS prevents the wheels from locking.

BAS helps you by providing additional brake force in an emergency braking situation.

If you depress the brake pedal quickly, BAS will be activated:

- BAS will automatically boost the brake force of the brakes
- BAS can shorten the braking distance
- ABS will prevent the wheels from locking

When you release the brake pedal, the brakes will function as usual again. BAS will be deactivated.

#### Functions of ASR (acceleration skid control)

ASR can neither reduce the risk of an accident nor override the laws of physics if the driver does not pay attention when pulling away or accelerating. ASR is only an aid. Always adapt your driving style to suit the prevailing road and weather conditions.

If ASR is malfunctioning, the  warning lamp lights up in the instrument cluster and the drive system performance may be reduced.

ASR improves traction, i.e. the transfer of power from the tires to the road surface, for a sustained period and therefore also improves the driving stability of the vehicle. If the drive axle wheels start to slip, ASR brakes individual wheels on the drive axle and limits the output of the drive system. ASR thus significantly assists you when pulling away and accelerating, especially on wet or slippery roads.

If traction on the road surface is not sufficient, even ASR will not allow you to pull away easily. The type of tires and total weight of the vehicle as well as the gradient of the road also play a crucial role.

If ASR intervenes, the  warning lamp in the instrument cluster flashes.

#### Function of ESP® (Electronic Stability Program)

**▲ WARNING** Risk of skidding if ESP® is deactivated

If you deactivate ESP®, ESP® cannot carry out vehicle stabilization.

▶ ESP® should only be deactivated in the following situations.

ESP® can, within physical limits, monitor and improve driving stability and traction in the following situations:

- When you are driving and pulling away on wet or slippery road surfaces
- When you are braking

If the vehicle is deviating from the direction desired by the driver, ESP® can intervene as follows to stabilize the vehicle:

- Applying the brakes to one or more wheels
- Adapting the drive system output according to the situation

**i** Use only wheels with the recommended tire sizes. Only then will ESP® function properly.

If the  warning lamp flashes, at least one wheel has reached its grip limit:

- Adapt your driving style to suit the prevailing road and weather conditions
- Do not deactivate ESP® under any circumstances
- Depress the accelerator pedal only as far as is necessary when pulling away

To improve traction, it may be appropriate to switch ESP® off in the following situations:

- When using snow chains
- In deep snow
- On sand or gravel

 Spinning the wheels will cause them to dig in to the surface, thereby enhancing traction.

If the  warning lamp lights up continuously, ESP® is not available due to a malfunction.

Observe the information on warning lamps and display messages (→ page 274).

If the  warning lamp lights up continuously, ESP® is deactivated.

Observe the following points when ESP® is deactivated:

- Vehicle stabilization will be delayed and will be significantly reduced in the lower speed range
  - The drive wheels may start to spin
  - Traction control will still be active
-  If ESP® is deactivated, ESP® will continue to assist you when you brake.

### Activating/deactivating ESP® (Electronic Stability Program)

On-board computer:

 Settings  Assistance  ESP 

 Select On or Off .

### Function of ESP® Crosswind Assist

ESP® Crosswind Assist detects sudden gusts of side wind and helps the driver to keep the vehicle in the lane:

- ESP® Crosswind Assist will be active at vehicle speeds above approximately 50 mph

(80 km/h) when you are driving straight ahead or on a slight bend.

- The vehicle will be stabilized by means of individual brake intervention on one side. The instrument cluster will show a message with the traffic sign for a strong crosswind.

ESP® Crosswind Assist will not react in the following circumstances:

- The vehicle is subjected to severe jolts and vibrations, e.g. as a result of bumps or pot-holes.
- The vehicle loses traction, e.g. on snow or ice or when hydroplaning.

### Function of ESP® Trailer Stability Assist

 **WARNING** Risk of accident in poor road and weather conditions

In poor road and weather conditions, the trailer stabilization cannot prevent lurching of the vehicle/trailer combination. Trailers with a high center of gravity may tip over before ESP® detects this.

 Always adapt your driving style to suit the current road and weather conditions.

When you are driving with a trailer, ESP® Trailer Stability Assist can stabilise your vehicle if it begins to swerve from side to side:

- ESP® Trailer Stability Assist is active at speeds above approx. 40 mph (65 km/h).
- Minor swerving is reduced by a targeted, individual brake intervention on one side.
- In the event of severe swerving, the drive output is also reduced and all wheels are braked.

ESP® Trailer Stability Assist may be restricted or out of operation in the following circumstance:

- The trailer is not connected correctly or is not recognized correctly by the vehicle.

### Function of EBD (Electronic Brakeforce Distribution)

EBD has the following characteristics:

- monitoring and controlling the brake pressure on the rear wheels
- improving driving stability when braking, especially on bends

### Function of Active Brake Assist

Active Brake Assist comprises the following functions:

- Distance warning function
- Autonomous braking function with collision warning
- Situation-dependent brake force boosting

From a speed of approx. 4 mph (7 km/h), Active Brake Assist can help you to minimize the risk of a collision with vehicles, cyclists or pedestrians, or mitigate the consequences.

If Active Brake Assist has detected a risk of collision, a warning tone sounds and warning lamp  lights up on the instrument cluster display.

If you do not react to the collision warning, autonomous braking can be initiated in critical situations. In particularly critical situations, Active Brake Assist can initiate autonomous braking directly. In this case, the warning lamp and warning tone are activated simultaneously with the braking application.

If you apply the brake yourself in a situation detected as critical by Active Brake Assist or apply the brake during autonomous braking, situation-dependent brake force boosting occurs. The brake pressure increases up to maximum full-stop braking if necessary.



If an autonomous brake application or situation-related brake force boosting was performed, the pop-up  appears on the instrument cluster display. It automatically disappears after a short time.

**⚠ WARNING** Risk of an accident caused by limited detection performance of Active Brake Assist

Active Brake Assist cannot always clearly identify objects and complex traffic situations.

In such cases, Active Brake Assist might:

- Give a warning or brake without reason
- Not give a warning or not brake

Active Brake Assist is only an aid. The driver is responsible for maintaining a sufficiently safe distance to the vehicle in front, vehicle speed and for braking in good time.

- ▶ Always pay careful attention to the traffic situation; do not rely on Active Brake Assist alone.
- ▶ Be prepared to brake or swerve if necessary.

Observe the system limits of Active Brake Assist. Due to the nature of the system, complex but non-critical driving conditions may also cause Active Brake Assist to intervene during braking.



If Active Brake Assist has been deactivated manually or by another driving system, the warning lamp  lights up on the instrument cluster display.

If the system is not available owing to soiled or damaged sensors or a malfunction, the warning lamp  lights up on the instrument cluster display.

#### Distance warning function

From a speed of approx. 18 mph (30 km/h), the distance warning function gives a warning if the following conditions are met:

- The difference in speed between the vehicle ahead and yours is a maximum of 18 mph (30 km/h).
- The distance to the vehicle ahead is insufficient for the current speed.

In this case, warning lamp  lights up on the instrument cluster display. If the distance to the vehicle in front is further reduced at higher speeds, warning lamp  starts to flash.

You can set the timing of the distance warning to immediately after detection of the insufficient distance (early) or to when the distance has been insufficient for several seconds (medium, late) (→ page 125).

### Autonomous braking function with collision warning

The autonomous braking function may intervene at speeds from approximately 4 mph (7 km/h) in the following situations:

- at speeds up to approx. 155 mph (250 km/h) for moving vehicles and cyclists ahead or pedestrians walking along the road
  - at speeds up to approx. 50 mph (80 km/h) for stationary vehicles
  - at speeds up to approx. 43 mph (70 km/h) for crossing vehicles, pedestrians and cyclists
  - when making a turn across the oncoming lane, before you leave your own lane, up to approx. 12 mph (20 km/h) if there are vehicles, pedestrians or two-wheelers approaching
- i** The response is limited in the case of stationary pedestrians and cyclists. At speeds up to approx. 43 mph (70 km/h), Active Brake Assist only responds to oncoming vehicles in your own lane with autonomous braking just before a possible collision. This reduces the potential impact speed. It enables you to evade the oncoming vehicle in good time if this is safely possible.

### Situation-dependent brake force boosting

The situation-dependent brake force boosting may intervene at speeds starting from approximately 4 mph (7 km/h) in the following situations:

- at speeds up to approx. 155 mph (250 km/h) for moving vehicles and cyclists ahead or pedestrians walking along the road
  - at speeds up to approx. 50 mph (80 km/h) for stationary vehicles
  - at speeds up to approx. 43 mph (70 km/h) for crossing vehicles, pedestrians and cyclists
- i** The response is limited in the case of stationary pedestrians and cyclists.

### Interruption of a brake application by Active Brake Assist

You can cancel a brake application by Active Brake Assist at any time by:

- emphatically depressing the accelerator pedal or with kickdown
- releasing the brake pedal (only during situation-related brake force boosting)
- steering clear of the detected obstacle

If there is no longer a risk of collision or the obstacle ahead is no longer detected, Active Brake Assist automatically cancels the brake application.

### Turning maneuver function

If the system detects a risk of collision with oncoming vehicles, pedestrians or two-wheelers when making a turn across the oncoming lane at speeds below approx. 12 mph (20 km/h), an autonomous braking intervention may be initiated before you have left your own lane.

### System limits

Full system performance is not yet available for a few seconds after switching on the vehicle or after moving off. Depending on the surrounding conditions it may take several minutes for the full system performance to be available.

The system may be impaired or may not function in the following situations:

- in snow, rain, fog, heavy spray, glare, direct sunlight or changing ambient light
- if the sensors are dirty, fogged up, damaged or obscured
- if the sensors are impaired owing to interference from other radar sources, e.g. intense radar reflections in parking garages
- if tire pressure loss or a defective tire has been detected and indicated
- if DSR is activated
- in complex traffic situations where objects cannot always be clearly identified
- if pedestrians or vehicles move quickly into the sensor detection range
- if pedestrians are hidden by other objects
- if the typical outline of a pedestrian cannot be distinguished from the background
- if a pedestrian is not detected as such, e.g. owing to special clothing or other objects
- on narrow curves

## Setting Active Brake Assist

### Requirements:

- The vehicle has been started.

On-board computer:

- Settings ▶ Assistance
- ▶ Active Brake Assist

The following settings are available:

- Early
- Medium
- Late
- Active Brake Assist is deactivated by removing the tick next to the **Early**, **Medium** or **Late** setting.

 It is recommended that Active Brake Assist always be left activated.

 Select a setting.

The last active setting is selected automatically each time the vehicle is started.



Exception: if the last setting was **Off**, the **Medium** setting will be automatically activated the next time the vehicle is started.

### Deactivating Active Brake Assist

 It is recommended that Active Brake Assist always be left activated.

 Remove the tick next to the **Early**, **Medium** or **Late** setting.

The distance warning function and the autonomous braking function are deactivated.

 If Active Brake Assist is deactivated, the  symbol appears on the status bar of the instrument cluster display.

## Cruise control

### Function of cruise control

Cruise control regulates the speed to the value selected by the driver.

If you accelerate to overtake, for example, the stored speed is not deleted. If you remove your foot from the accelerator pedal after overtaking, cruise control will resume speed regulation back to the stored speed.

You can store any speed above 13 mph (20 km/h) up to the maximum design speed or up to the stored winter tire limit.

Observe the information on driving systems and be aware of your personal responsibility, other-

wise you may fail to recognize potential dangers (→ page 119).

### Notifications on the instrument cluster display

 **Gray:** cruise control is selected but not yet active or temporarily in passive mode.

 **Green:** cruise control is activated.

A stored speed is shown alongside the display  and is indicated in the speedometer.

### System limits

Cruise control may be unable to maintain the stored speed on uphill gradients. The stored speed is resumed when the uphill gradient evens out and the vehicle's speed does not fall below 13 mph (20 km/h).

On long and steep downhill gradients, you must increase recuperation in good time. This is particularly important when driving a heavily-laden vehicle. The electric motor's braking effect can thus be used to charge the high-voltage battery. This will take some of the strain off the brake system and prevent the brakes from overheating and wearing too quickly.

Do not use cruise control in the following situations:

- in traffic situations that require frequent changes of speed, e.g. in heavy traffic, on winding roads
- off-road or on construction sites
- on slippery or slick roads, as the drive wheels can lose traction when accelerating and the vehicle can then begin skidding
- if there is poor visibility

### Operating cruise control

 **WARNING** Risk of accident due to stored speed

If you call up the stored speed and this is lower than your current speed, the vehicle decelerates.

 Take into account the traffic situation before calling up the stored speed.

### Requirements:

- The transmission is in position **D**.
- Travel speed is at least 15 mph (20 km/h).
- ESP® is activated, but not intervening.
- Cruise control is selected.

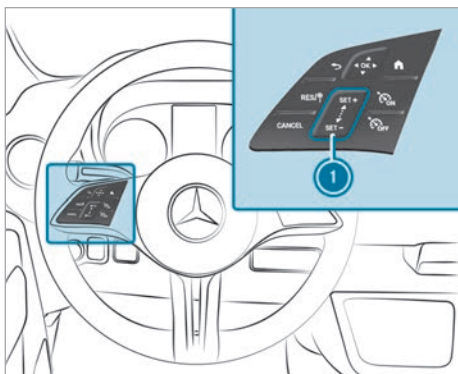

Steering wheel control panel for cruise control

|  |  |
|--|--|
|  | Adopts the stored speed                  |
|  | Deactivates cruise control               |
|  | Control panel to increase/decrease speed |
|  | Activates cruise control                 |
|  | Deactivates cruise control               |

### Activating cruise control

▶ Press .

### Activating cruise control

▶ Press on the control panel ①.  
The current speed is stored and maintained by the vehicle.

or

▶ Press .

The last stored speed is called up and maintained by the vehicle.

The current travel speed is stored if the last stored speed has been deleted.

① When you switch off the vehicle, the last stored speed is deleted.

### Increasing/decreasing the stored speed

- ▶ **To increase:** Swipe across the switch panel ① from the bottom up.
  - The stored speed is increased by 1 mph (1 km/h).
- ▶ **To decrease:** Swipe across the switch panel ① from the top down.
  - The stored speed is decreased by 1 mph (1 km/h).
- ▶ **To decrease:** Swipe across the switch panel ① from the top down.
  - The stored speed is decreased by 1 mph (1 km/h).

or

▶ Briefly press or on the control panel ①.

The stored speed is increased or decreased to the following values according to the respective unit:

- **mph:** the next value ending in 5 or 0
- **km/h:** the next value ending in 0

or

- ▶ Accelerate the vehicle to the desired speed.
- ▶ Press on the control panel ①.

### Deactivates cruise control

▶ Press .

### Deactivates cruise control

▶ Press .

① If you brake, deactivate ESP®, or if ESP® intervenes, cruise control is deactivated.

### Setting the speed limitation for winter tires

On-board computer

↳ Settings ▶ Vehicle ▶ Winter Tire Limit

▶ Select a speed or deactivate the function.

### Active Distance Assist DISTRONIC

#### Function of Active Distance Assist DISTRONIC

Active Distance Assist DISTRONIC is available only for vehicles with automatic transmission.

Active Distance Assist DISTRONIC maintains the set speed on a free-flowing road. If vehicles are detected ahead the set distance is maintained, if necessary until the vehicle comes to a standstill. The vehicle is accelerated or braked in correlation with the distance to the vehicle in front and with the set speed.

Speed and distance are set and stored on the steering wheel.

Available speed range: 13 mph (20 km/h) - 100 mph (160 km/h)

Other features of Active Distance Assist DISTRONIC:

- Initiates acceleration to the stored speed if the turn signal indicator is switched on to change to the overtaking lane.
- Adaptation of the driving style depending on the selected drive program (energy-saving or comfortable).
- Reaction to detected stationary vehicles up to a speed of > 19 mph (30 km/h) (with the exception of bicycles and motorcycles).

#### Notifications of Active Distance Assist DISTRONIC on the instrument cluster display

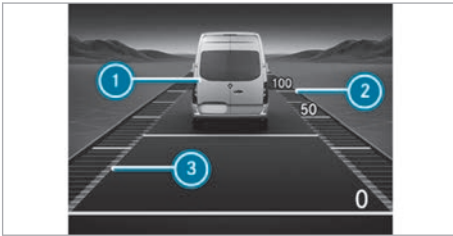

Assistance graphic (example)

- ① Vehicle in front
- ② Distance indicator
- ③ Set specified distance

The vehicle detected in front ① is highlighted in green. It may also be in the lane to the left of your vehicle in situations where it is not permitted to overtake on the right, for example, on freeways.

#### Permanent status display

- Gray:** Active Distance Assist DISTRONIC selected but not yet active.
- Green speedometer, gray vehicle:** Active Distance Assist DISTRONIC active, speed set.
- Green:** Active Distance Assist DISTRONIC active and vehicle detected.

The stored speed is shown under the permanent status display and indicated in the speedometer. The Active Distance Assist DISTRONIC status display is grayed out when in passive mode.

If the speed of the vehicle in front or the ascertained target speed due to the route event ahead is less than the stored speed, the segments in the speedometer light up.

If you increase or decrease the specified distance ③, the notification appears briefly.

- ① DISTRONIC starts up again automatically within 3 seconds. The green vehicle symbol is displayed cyclically when the vehicle is ready to pull away.
- ① The system can be switched to passive mode by depressing the accelerator pedal while Active Distance Assist DISTRONIC is active. The **Passive** message appears briefly on the instrument cluster display.

#### System limits

The system may be impaired or inoperative in the following situations, for example:

- In snow, rain, fog, heavy spray, if there is glare, in direct sunlight or in greatly varying light conditions.
- If the windshield is dirty, fogged up, damaged or obscured in the vicinity of the camera.
- If there is dirt on the radar sensors or if the radar sensors are covered.
- In parking garages or on roads with steep uphill or downhill gradients.
- If there are narrow vehicles in front, such as bicycles or motorcycles.

In addition, on slippery or slick roads, braking or accelerating can cause one or several wheels to lose traction and the vehicle could then begin skidding.

Do not use Active Distance Assist DISTRONIC in these situations.

#### **⚠ WARNING** Risk of accident from acceleration or braking by Active Distance Assist DISTRONIC

Active Distance Assist DISTRONIC may accelerate or brake in the following cases, for example:

- If the vehicle pulls away using Active Distance Assist DISTRONIC.
- If the stored speed is called up and is considerably faster or slower than the currently driven speed.
- If Active Distance Assist DISTRONIC no longer detects a vehicle in front or does not react to relevant objects.

- ▶ Always carefully observe the traffic conditions and be ready to brake at all times.
- ▶ Take into account the traffic situation before calling up the stored speed.

**▲ WARNING** Risk of accident due to insufficient deceleration by Active Distance Assist DISTRONIC

Active Distance Assist DISTRONIC brakes your vehicle with up to 50% of the possible deceleration. If this deceleration is not sufficient, Active Distance Assist DISTRONIC alerts you with a visual and acoustic warning.

- ▶ Adjust your speed and maintain a suitable distance from the vehicle in front.
- ▶ Brake the vehicle yourself and/or take evasive action.

**▲ WARNING** Risk of accident if detection function of Active Distance Assist DISTRONIC is impaired

Active Distance Assist DISTRONIC does not react or has a limited reaction:

- when driving on a different lane or when changing lanes
- to pedestrians, animals, bicycles or stationary vehicles, or unexpected obstacles
- to complex traffic conditions
- to oncoming vehicles and crossing traffic

As a result, Active Distance Assist DISTRONIC may neither give warnings nor intervene in such situations.

- ▶ Always observe the traffic conditions carefully and react accordingly.

## ■ Operating Active Distance Assist DISTRONIC

### Requirements:

Active Distance Assist DISTRONIC:

- The parking brake has been released.
- ESP® is activated and is not intervening.
- The transmission is in position **D**.
- The doors and the rear-end doors are closed.
- Checking of the radar sensor system has been successfully completed.
- The driver's seat belt is fastened.

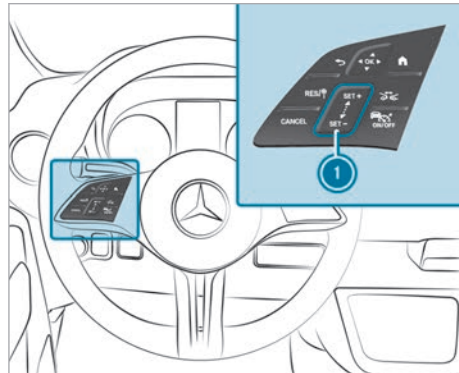

Adopts the stored speed



Deactivating Active Distance Assist DISTRONIC

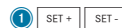

Control panel to increase/decrease speed



Increases/decreases the specified distance



Activates/deactivates Active Distance Assist DISTRONIC

- ▶ **To operate Active Distance Assist DISTRONIC:** press the respective button with only one finger or swipe across the control panel.

### Activates/deactivates Active Distance Assist DISTRONIC

- ▶ Press .

### Activating Active Distance Assist DISTRONIC

- ▶ **To activate without a stored speed:** press the control panel at the top or at the bottom or press . Remove your foot from the accelerator pedal.

or

- ▶ **To activate with a stored speed:** press . Remove your foot from the accelerator pedal. The last stored speed is called up and maintained by the vehicle.

If the stored speed has been deleted, the current vehicle speed is stored.

### Increasing or decreasing the stored speed

- ▶ **To increase:** swipe the control panel from the bottom up. The speed is increased by 1 mph (1 km/h).
- ▶ **To decrease:** swipe the control panel from the top down. The speed is decreased by 1 mph (1 km/h).

or

- ▶ Press **SET+** or **SET-** briefly on the control panel . The speed is increased or decreased by 5 mph (10 km/h).

or

- ▶ Press and hold **SET+** or **SET-** on the control panel . The speed is increased or decreased in 5 mph (10 km/h) increments.

or

- ▶ Accelerate the vehicle to the desired speed.
- ▶ Press **SET+** on the control panel .



### Pulling away with Active Distance Assist DISTRONIC

- ▶ Activate Active Distance Assist DISTRONIC and remove your foot from the brake pedal.
- ▶ Press **RES/Ⓜ**.

or

- ▶ Depress the accelerator pedal briefly and firmly. The functions of Active Distance Assist DISTRONIC remain active.

### Reducing or increasing the specified distance from the vehicle in front

- ▶ Press . The  notification appears. The specified distance is reduced by one level. If the lowest level is already selected, the selection jumps to the highest level.

### Deactivating Active Distance Assist DISTRONIC

- ⚠ WARNING** Risk of an accident due to Active Distance Assist DISTRONIC being active when you leave the driver's seat

If you leave the driver's seat while the vehicle is being braked by Active Distance Assist DISTRONIC only, the vehicle can roll away.

- ▶ Always deactivate Active Distance Assist DISTRONIC and secure the vehicle to prevent it from rolling away before you leave the driver's seat.

- ▶ Press **CANCEL**.

-  If you brake, deactivate ESP® or if ESP® intervenes, Active Distance Assist DISTRONIC is deactivated.

### Information on Hill Start Assist

Hill Start Assist holds the vehicle for a short time when pulling away on a hill under the following conditions:

- The transmission is in position **D** or **R**.
- The parking brake has been released.

This gives you enough time to move your foot from the brake pedal to the accelerator pedal and depress it before the vehicle begins to roll.

- ⚠ WARNING** Risk of accident and injury due to the vehicle rolling away

After a short time, Hill Start Assist no longer holds the vehicle.

- ▶ Swiftly move your foot from the brake pedal to the accelerator pedal. Do not leave the vehicle when it is being held by Hill Start Assist.

### HOLD function

#### Notes on the HOLD function

#### Function

The HOLD function holds the vehicle at a standstill without you needing to depress the brake pedal, e.g. when pulling away on a slope or when waiting in traffic. When you depress the accelerator pedal to pull away, the braking effect is canceled and the HOLD function is deactivated.

The HOLD function is only an aid. Responsibility for keeping the vehicle safely at a standstill remains with the driver.

#### System limits

The HOLD function is intended only to provide assistance during driving operation and is not an adequate means of securing the stationary vehicle against rolling away.

The incline cannot be greater than 30%.

### Activating/deactivating the HOLD function

**▲ WARNING** Risk of an accident due to the HOLD function being active when you leave the vehicle

If the vehicle is only braked with the HOLD function it could, in the following situations, roll away:

- If there is a malfunction in the system or in the power supply.
  - If the HOLD function is deactivated by depressing the accelerator pedal or brake pedal, e.g. by a vehicle occupant.
- ▶ Always secure the vehicle against rolling away before you leave it.

#### Requirements:

- The vehicle is stationary.
- The vehicle has been started.
- The driver is seated and belted.
- The electric parking brake is released.
- The transmission is in position **D**, **R** or **N**.

#### Activating the HOLD function

▶ Depress the brake pedal until the symbol **HOLD** is displayed in the instrument cluster.

▶ Release the brake pedal.

ⓘ If depressing the brake pedal the first time does not activate the HOLD function, wait briefly and then try again.

#### Deactivating the HOLD function

▶ Depress the accelerator pedal to move off.  
or

▶ Depress the brake pedal until the symbol **HOLD** in the instrument cluster disappears.

ⓘ After a short period of time, the transmission shifts to position **P** to relieve the load on the service brake.

When the HOLD function is activated, the transmission automatically shifts to position **P** in the following situations:

- The driver unbuckles the seat belt and leaves the driver's seat.
- The driver's door is opened.
- The vehicle is switched off.

### Reversing camera with inside mirror display

#### Function of the reversing camera with inside mirror display

The reversing camera is connected to the vehicle's inside mirror. When you engage reverse gear, the image of the reversing camera appears in the left area of the inside mirror. It is thus possible to see what is behind the vehicle when you are reversing.

The reversing camera with inside mirror display serves solely as an aid. It is not a substitute for you having to pay attention to your surroundings. You are always responsible for safe maneuvering and parking. Ensure that no persons, animals, objects, etc. are in the maneuvering area while maneuvering and parking.

The reversing camera with inside mirror display may show a distorted view of obstacles, show them incorrectly or even omit them altogether. It cannot show all objects in immediate proximity to or beneath the rear bumper. It will not warn you of a collision, people or objects.

The area behind the vehicle is displayed as a mirror image.

#### System limits

The reversing camera with inside mirror display will either not function or function only partially in the following situations:

- If there is heavy rain, snow or fog.
- If the light conditions are poor, e.g. at night.
- If the surroundings are illuminated with fluorescent lighting, the inside mirror display may flicker
- If there is a rapid change in temperature, e.g. if you drive out of the cold into a heated garage during the winter months
- If the ambient temperature is very high
- If the camera lens is obstructed, dirty or fogged up. Observe the notes on cleaning the reversing camera (→ page 173).
- The camera or rear of your vehicle is damaged. In this event, have the camera, its position and its setting checked at a qualified specialist workshop.

The field of vision and other functions of the reversing camera may be restricted due to additional vehicle attachments on the rear of the vehicle (e.g. license plate bracket or bicycle rack).

- ❶ The inside mirror display contrast may be impaired due to direct sunlight or other light sources. Particular attention should be afforded in these conditions.
- ❷ Have the inside mirror repaired or replaced if, for example, its use is considerably restricted due to pixel errors.
- ❸ Objects that are not at ground level appear further away than they are.

Examples of such objects include:

- the bumper of a vehicle parked behind
- the drawbar of a trailer
- the ball neck of a trailer hitch
- the tail-end of a truck
- slanted posts

### ■ Displaying and hiding the inside mirror display

#### Displaying

- ▶ Engage reverse gear.  
The image of the reversing camera appears on the left side of the inside mirror.
- ❶ Observe the system limits of the reversing camera with an inside mirror display.

#### Hiding

- ▶ Engage a different transmission position.  
or
- ▶ Switch off the vehicle.  
The display will be hidden after a short time.

## ATTENTION ASSIST

### ■ Function of ATTENTION ASSIST

ATTENTION ASSIST assists you on long, monotonous journeys, e.g. on freeways and highways. If signs of fatigue or increasing lapses in concentration on the part of the driver are detected, the system suggests taking a break.

ATTENTION ASSIST serves solely as an aid. It cannot always promptly detect fatigue or lapses in concentration. The system is not a substitute for a well-rested and attentive driver. On long journeys, take regular, timely breaks to allow for adequate recovery.

You can choose between two settings:

- **Standard:** normal system sensitivity.
- **Sensitive:** higher system sensitivity. The driver is warned at an earlier stage, and the attention level detected by the system is adapted accordingly.

If fatigue or increasing lapses in concentration are detected, the warning **ATTENTION ASSIST: Take a Break!** appears on the instrument cluster display.

You can acknowledge the message and take a break as necessary. If you do not take a break and ATTENTION ASSIST continues to detect increasing lapses in concentration, you will be warned again after a minimum of 15 minutes.

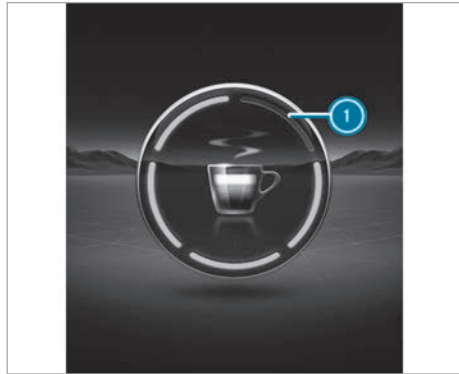

The following information is shown on the instrument cluster display:

- journey time since the last break
- the attention level determined by ATTENTION ASSIST

The more segments ❶ of the circle displayed, the higher the detected attention level. Fewer segments ❶ will be displayed in the circle as your attention level decreases, with the color of the diminishing circle segments changing from green, to orange, to red accordingly.

If ATTENTION ASSIST cannot calculate attention levels, and consequently cannot issue a warning, the **System Passive** message appears.

When you restart the vehicle, ATTENTION ASSIST is automatically switched on. The last selected sensitivity level remains stored.

You can call up the ATTENTION ASSIST display (Attention Level) in the **Trip** menu of the instrument cluster (→ page 148).

If the indicator lamp  on the instrument cluster display lights up, ATTENTION ASSIST is faulty.

#### System limits

ATTENTION ASSIST is active in the 37 mph (60 km/h) to 124 mph (200 km/h) speed range.

The functionality of ATTENTION ASSIST is restricted, and warnings may be delayed or not issued at all in the following situations in particular:

- If you have been driving for less than approximately 30 minutes.
- If the road condition is poor (uneven road surface or potholes).
- If there is a strong side wind.
- If you adopt a sporty driving style (high cornering speeds or high rates of acceleration).
- If the clock is set to the incorrect time.
- If you change lanes and vary your speed frequently in active driving situations.

Refer to the information regarding display messages that can be shown on the instrument cluster display.

The ATTENTION ASSIST drowsiness or attentiveness assessment is deleted and restarted when continuing the journey in the following situations:

- You switch off the vehicle.
- You unfasten your seat belt and open the driver's door (e.g. to change drivers or take a break).

### Setting ATTENTION ASSIST

On-board computer:

- ➔ Settings ➔ Assistance
- ➔ ATTENTION ASSIST

### Setting options

The following settings are available:

- Standard
- Sensitive
- Off

- ▶ Select a setting.

### Setting the warnings

- ▶ Select **Microsleep Warning** or **Distraction Warning**.
- ▶ Activate or deactivate the function.

### Blind Spot Assist

#### Function of Blind Spot Assist

Blind Spot Assist uses two lateral, rear-facing radar sensors to monitor the area up to 130 ft (40 m) behind and 10 ft (3 m) next to your vehicle.

If a vehicle is detected above speeds of approximately 8 mph (12 km/h) and this vehicle subse-

quently enters the monitored range directly next to your vehicle, the warning lamp in the exterior mirror lights up red.

Status indicator on the display of the instrument cluster



**Gray:** the system is activated but inoperative.



**Green:** the system is activated and operational.

If a vehicle is detected close to your vehicle and you switch on the turn signal indicator in the corresponding direction, a double warning tone sounds and the red warning lamp in the exterior mirror flashes. If the turn signal indicator remains switched on, the double warning tone sounds once for each detected vehicle.

If you overtake a vehicle briskly, no warning is given.

#### **WARNING** Risk of accident despite Blind Spot Assist

Blind Spot Assist does not react to either stationary objects or vehicles approaching and overtaking you at a greatly different speed.

Blind Spot Assist cannot warn drivers in these situations.

- ▶ Always pay careful attention to the traffic situation and maintain a safe distance at the side of the vehicle.

Observe the notes on driving systems and your responsibility; you may otherwise fail to recognize dangers (→ page 119).

#### Exit warning

The exit warning is an additional function of Blind Spot Assist and can warn vehicle occupants of any approaching vehicles when leaving the stopped vehicle.

#### **WARNING** Risk of accident despite exit warning

The exit warning neither reacts to stationary objects nor to persons or road users approaching you at a greatly differing speed.

The exit warning cannot warn drivers in these situations.

- ▶ Always pay particular attention to the traffic situation when opening the doors and make sure there is sufficient clearance.

If a vehicle is detected in the monitoring range, the warning lamp in the exterior mirror lights up. If a vehicle occupant opens the front door on the side subject to a warning, a warning tone sounds and the warning lamp in the exterior mirror starts to flash. An exit warning is not issued for the sliding doors.

This additional function is available only when Blind Spot Assist is switched on. The exit warning can warn you from switching on up to a maximum of three minutes after switching off the vehicle. The end of the availability of the exit warning function is indicated by three flashes of the warning lamp in the exterior mirror.

The exit warning is only an aid and is no substitute for the attentiveness of the vehicle occupants. Responsibility always lies with the vehicle occupants when opening doors and leaving the vehicle.

### System limits

Blind Spot Assist may in particular be limited in the following situations:

- if the sensors are soiled or obscured
- if there is poor visibility, e.g. owing to fog, heavy rain, snow or spray
- if narrow vehicles are within the monitored range, e.g. bicycles
- if the road has very wide or very narrow lanes
- if vehicles are not driving in the middle of their lane

Observe also the information on vehicle sensors and cameras (→ page 119).

Warnings may be issued in error when driving close to crash barriers or similar solid lane borders. Always ensure that there is a sufficient distance at the side to other road users or obstacles.

Warnings may be interrupted when driving alongside long vehicles for an extended time, e.g. trucks.

Blind Spot Assist is not operational when reverse gear is engaged.

If something is attached to the trailer hitch, e.g. a trailer or a bicycle rack, and the electrical connection is correctly established, Blind Spot Assist and the exit warning function are not available.

The exit warning function may be limited in the following situations:

- when the sensor is blocked by adjacent vehicles in narrow parking spaces
- when people are approaching
- in the case of stationary or slow-moving objects

### ■ Activating/deactivating Blind Spot Assist

On-board computer:

↳ Settings

▶ Activate or deactivate **Blind Spot Assist**.

### Sideguard Assist

#### ■ Function of Sideguard Assist

When turning off or changing lanes, Sideguard Assist can issue a warning if there is a risk of collision with moving objects in the monitored area on the front passenger side.

Sideguard Assist is always active after starting the vehicle. You can only manually deactivate the acoustic warning signal of Sideguard Assist (→ page 134). The acoustic warning signal becomes active again when you restart the vehicle.

**⚠ WARNING** Risk of accident due to limitations of Sideguard Assist in the detection of objects and traffic conditions

Sideguard Assist cannot always clearly identify objects and complex traffic situations. In such cases, Sideguard Assist may:

- issue an unnecessary warning
- not issue a warning

▶ Drive on carefully and be ready to brake, particularly if the system issues a warning.

▶ Always pay close attention to the traffic situation and maintain a safe distance at the side of the vehicle.

- ① Sideguard Assist warns you of objects moving at up to 25 mph (40 km/h) in the monitored area on the front passenger side.
- ① Sideguard Assist warns you if your own vehicle speed is up to a maximum of 18 mph (30 km/h).
- ① No warnings are issued for moving pedestrians or objects in the monitored area.

- ❗ Sideguard Assist is not a parking assistance system.

### Monitored side area

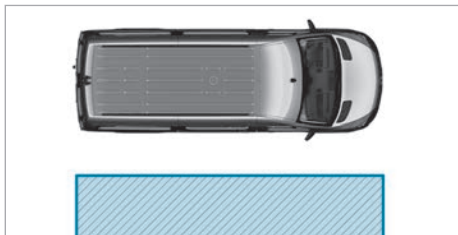

- The warning area extends along the entire vehicle length.
- The width of the warning area is approx. 3.5 m (12 ft)

### System limits

There may be unwarranted system responses when driving a left-hand drive vehicle in left-side traffic or a right-hand drive vehicle in right-side traffic. Switch off the acoustic warning signal of Sideguard Assist.

Sideguard Assist may be impaired or inoperative in the following situations in particular:

### System-related:

- Sideguard Assist will not be active while you are backing up.
- The function is automatically deactivated when driving with a trailer.
- Owing to the system characteristics, warnings may be interrupted when you are driving alongside particularly long vehicles, for example trucks, for a prolonged time.

### Situation-related:

- Objects are concealing pedestrians or cyclists.
- Pedestrians or cyclists suddenly change their direction or speed.
- Persons or vehicles move rapidly into the detection range of the sensors.
- Objects are moving at the same speed as your own vehicle.
- Multi-lane-change from the passing lane.
- Soiling, ice, snow, stickers, decals or detachable parts are obscuring the sensors.

- ❗ Sensors must not be painted over.

### Environment-related:

- Very wide lanes
- Very narrow and winding lanes
- Sensor interference, e.g. caused by severe, unfavorable radar reflection from guardrails or other infrastructure

In the following cases in particular, have the function of the radar sensors checked at a qualified specialist workshop:

- After a severe impact
- After damage to the side trim

### Deactivating/activating the warning tone (instrument cluster)

Deactivating/activating on the instrument cluster

➔ Settings ➔ Assistance

▶ Deactivating or activating Sideguard Assist.

Indicator on the instrument cluster:

- Sideguard Assist is always active. The function cannot be manually deactivated. Its active status is not shown on the instrument cluster display.
-  Warning tone has been manually deactivated.

If there is a risk of collision, only the red triangle on the outside mirror will be shown.

-  System is temporarily or permanently switched off owing to a system malfunction, e.g. dirt on the sensors.

In addition, a display message reading **Sideguard Assist Warning Inoperative** may appear.

### Warning by Sideguard Assist

Object detected in the monitoring range

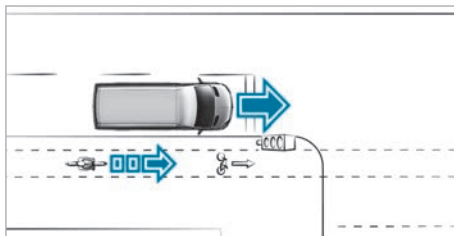

Example: left-hand drive vehicle

A moving object is detected in the monitored area:

- Red warning symbol  lights up in the right exterior mirror.

#### Risk of collision detected

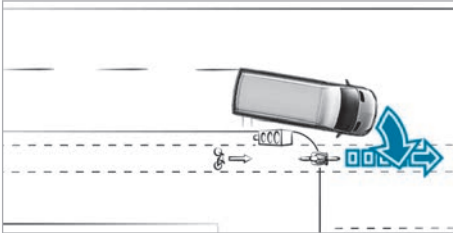

Example: left-hand drive vehicle

A risk of collision is detected when the turn signal indicators are switched on:

- Red warning symbol  flashes in the right exterior mirror.
- An audible warning is given.

For the following reasons, a warning may not be given despite a risk of collision on the front passenger side:

- Sideguard Assist has failed or there is a malfunction.
- The acoustic warning signal of Sideguard Assist has been manually deactivated.

If there is a risk of collision, the red warning symbol  continues to be shown in the exterior mirror.

### Moving-off Information Assist

#### Function of Moving-off Information Assist

The function monitors a certain area  and gives a warning if there are . cyclists or pedestrians etc. in this area. The area is generated and defined depending on the steering angle of the vehicle.

#### Monitored area

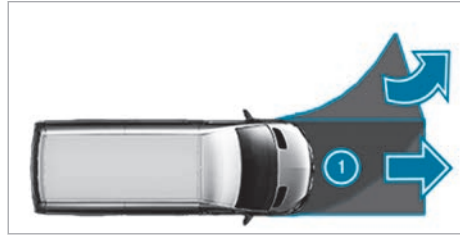

Monitored area (example)

Moving-off Information Assist may be impaired or inoperative in the following situations in particular:

#### System-related:

- Moving-off Information Assist will not be active while the vehicle is backing up.

#### Situation-related:

- Objects are concealing pedestrians or cyclists.
- Pedestrians or cyclists suddenly change their direction or speed.
- Persons or vehicles move rapidly into the detection range of the sensors.
- Objects are moving at the same speed as your own vehicle.  
Soiling, ice, snow, stickers, decals or detachable parts are obscuring the sensors.

 Sensors must not be painted over.

#### Environment-related:

- If the sensors are impaired, such as by severe or unfavorable radar reflection from guardrails or other infrastructure

**Especially in the following cases, have the function of the sensors checked at a qualified specialist workshop:**

- After a severe impact
- After damage to the side trim

#### Deactivating/activating Moving-off Information Assist (instrument cluster)

Activating/deactivating on the instrument cluster

 Settings  Assistance

 Activating/deactivating Moving-off Information Assist.

Indicator on the instrument cluster:

- Moving-off Information Assist is always active. The function can be deactivated manually only

for the current vehicle start. Its active status is not shown on the instrument cluster display.

-  - System is switched off temporarily as a result of manual deactivation or permanently owing to a system malfunction, e.g. dirt on the sensors.

In addition, a display message reading **Moving-off Information Assist Inoperative** may appear.

### ■ Warning by Moving-off information Assist

Moving object is detected in the monitored area:

- Yellow warning symbol  lights up in the instrument cluster.

Sensor is soiled:

- Yellow warning symbol  lights up in the instrument cluster.

Risk of collision is detected:

- Red warning symbol  lights up in the instrument cluster.
- An audible warning is given.

For the following reasons, a warning may not be given despite a risk of collision:

- Moving-off information Assist has failed or there is a malfunction.

## Active Lane Keeping Assist

### ■ Function of Active Lane Keeping Assist

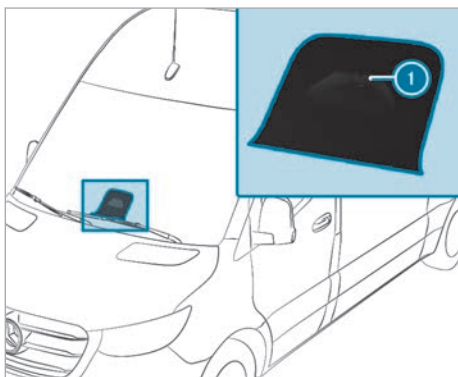

Active Lane Keeping Assist monitors the area ahead of your vehicle with the multifunction camera  and can protect you from unintentionally leaving your lane. The system can guide you back into your lane with course-correcting steering inter-

ventions, and also warn you with tangible steering wheel feedback.

Active Lane Keeping Assist is available at speeds above approximately 37 mph (60 km/h).

The system can intervene under the following conditions:

- Active Lane Keeping Assist detects a lane marking.
- A front wheel of your vehicle moves onto this lane marking.

If you activate the turn signal indicator, no steering intervention takes place on the relevant side.

If you leave your lane without activating the turn signal indicator, but the risk of collision with a moving obstacle in your own lane is detected, there is no steering intervention.

**Vehicles with Blind Spot Assist:** if the system detects an obstacle, e.g. another vehicle in the adjacent lane, steering intervention takes place despite the turn signal indicators.

Depending on the country, Active Lane Keeping Assist can already react in the following situations from a speed of approximately 28 mph (45 km/h):

- If your own vehicle is overtaken by another road user and a risk of collision is detected, there is course-correcting steering intervention.
- If you drive over a detected lane marking, the system will issue a warning via haptic feedback through the steering wheel.

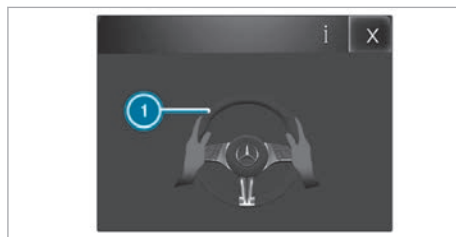

In the following cases symbol  appears in the instrument cluster display and a warning tone sounds:

- A steering intervention by Active Lane Keeping Assist lasts longer than approx. ten seconds.
- There are two or more steering interventions by the system within approx. three minutes without steering intervention by the driver.

You can set the sensitivity of the system in the settings of Active Lane Keeping Assist to determine the level of support required. You can also determine whether the system is to react to interrupted or only to solid lane markings .

#### Active Lane Keeping Assist status displays



**White:** Active Lane Keeping Assist is switched off.

If ESP® is switched off or a tire pressure loss warning appears, Active Lane Keeping Assist will automatically be switched off.



**Yellow:** there is a malfunction. Also observe any messages on the display.



**Gray:** Active Lane Keeping Assist is switched on but not ready.



**Green:** Active Lane Keeping Assist is switched on and ready. If the system is only available on one side, only the lane marking on that side is shown in green.



**Red:** Active Lane Keeping Assist has guided you back into your lane with a course-correcting steering intervention. The status display flashes if there is also a tangible warning at the steering wheel. Only the lane marking on the side for which the warning was issued is shown in red.

#### Display of Active Lane Keeping Assist in the Assistance menu



If a front wheel moves onto a detected lane marking, this is highlighted in red on the instrument cluster display in the Assistance menu.

#### System limits

In the following situations, there may be no course-correcting steering intervention, but possibly a tangible warning in the steering wheel:

- if you actively steer, brake or accelerate
- if a driving safety system intervenes, such as ESP®, Active Brake Assist or Blind Spot Assist
- if you have adopted a sporty driving style with high cornering speeds or high rates of acceleration
- if transport equipment, e.g. a trailer or bicycle rack, is attached to the trailer hitch and the electrical connection has been correctly established

The system may be impaired or inoperative in the following situations in particular:

- if there is poor visibility, e.g. due to insufficient illumination of the road, highly variable light/shadow conditions, rain, snow, fog or heavy spray
- if there is glare, e.g. from oncoming traffic, direct sunlight or from reflections
- If there is dirt on the windshield in the vicinity of the multifunction camera or if the camera is fogged up, damaged or obscured
- if the bumper is soiled in the area of the radar sensors, or if these are damaged or covered
- if there are no lane markings, or several unclear lane markings are present for one lane, e.g. around roadwork
- if the lane markings are worn away, dark or covered
- if the distance to the vehicle in front is too short and the lane markings cannot be detected
- if the lane markings change quickly, e.g. lanes branch off, cross one another or merge
- if the lanes are very narrow and winding

Observe the notes on driving systems and your responsibility. You may otherwise fail to recognize potential dangers.(→ page 119)

#### Activating/deactivating Lane Keeping Assist and Active Lane Keeping Assist

On-board computer:

→ Settings → Assistance

- ▶ Depending on vehicle equipment, select **Act. Lane Keeping Assist** or **Lane Keeping Assist**. The driving system is activated or deactivated, depending on its previous status.

## Trailer operation

### Notes on trailer operation

**⚠ WARNING** Risk of accident and injury if the tongue weight is exceeded

The carrier system may detach from the vehicle, thereby endangering other road users.

- ▶ Always comply with the permissible tongue weight when using a carrier.

**⚠ WARNING** Risk of accident due to unsuitable ball neck

If you install an unsuitable ball neck, the trailer hitch and the rear axle may be overloaded.

This can significantly impair the driving characteristics and the trailer may become loose. There is a risk of fatal injury.

- ▶ Only install a ball neck that complies with the permissible dimensions and is designed for the requirements of trailer operation.
- ▶ Do not modify the ball neck or the trailer hitch.

You can find specifications regarding the ball neck on the trailer's identification plate. You can find specifications regarding the trailer on the towing vehicle's identification plate and in the Technical Data (→ page 247).

**⚠ WARNING** Risk of accident and injury due to incorrectly installed ball neck

If the ball neck is not properly mounted and secured, it may come loose along with the trailer while the vehicle is in motion and endanger other road users. There is a risk of fatal injuries.

- ▶ Mount and secure the ball neck as described in the installation instructions of the ball neck manufacturer.
- ▶ With the ball neck mounted, always make sure it is properly secured before commencing a journey.

**⚠ WARNING** Risk of accident due to a ball neck that is not correctly installed or secured

If the ball neck is not correctly installed and secured, the trailer may come loose.

▶ Install and secure the ball neck as described in the ball neck manufacturer's installation instructions.

▶ If a ball neck is installed, ensure sure that it is properly secured before every journey.

**!** **NOTE** The operating permit may be invalidated due to the illegal installation of trailer hitches

The installation – including retrofitting – of a non-folding or non-removable trailer hitch that even partially conceals the license plate or the lighting system is prohibited.

▶ Observe the applicable legal regulations for the installation of trailer hitches.

Be sure to comply with the operating instructions of the manufacturer of the trailer coupling and the ball neck.

Place your vehicle/trailer combination on surfaces that are as even as possible and secure it against rolling away (→ page 116). Couple and uncouple the trailer carefully.

When backing up the towing vehicle, ensure that there is no one between the vehicle and the trailer.

If you do not couple the trailer to the towing vehicle correctly, the trailer may become detached. Once it has been coupled and is roadworthy, the trailer must be in a horizontal position behind the towing vehicle.

Note the following regarding the tongue weight:

- Make full use of the maximum tongue weight, where possible.
- Never allow the tongue weight to fall below a legally prescribed minimum; the tongue weight must always be positive.
- Do not exceed or fall below the permissible tongue weights – this must be observed during loading and unloading of the trailer.

Do not exceed the following values:

- Permitted braked or unbraked trailer load  
The maximum permissible trailer load for unbraked trailers is 1653 lbs (750 kg).
- Permissible rear axle load of the towing vehicle
- Gross vehicle weight rating of the towing vehicle
- Gross vehicle weight rating of the trailer

- Permissible gross combination weight
- Maximum permissible speed of the trailer

The relevant permitted values, which must not be exceeded, can be found in the following places:

- in your vehicle documents
- on the identification plate of the trailer hitch
- on the trailer identification plate
- on the vehicle identification plate

If there are discrepancies between the values, the lowest one shall apply.

Before driving off, ensure the following:

- The tire pressure on the rear axle of the towing vehicle has been set for the maximum load.
- The headlamps have been set correctly.

Tire pressure approved by the manufacturer can be found on the identification plates and, for the towing vehicle, in the tire pressure table overview (→ page 191).

Your vehicle will behave differently with a trailer relative to without a trailer:

- The vehicle/trailer combination will be heavier.
- The vehicle/trailer combination will be restricted in its acceleration and gradeability.
- The vehicle/trailer combination will have an increased braking distance.
- The vehicle/trailer combination will be more susceptible to crosswind gusts.
- The vehicle/trailer combination will require more sensitive steering.
- The vehicle/trailer combination will have a larger turning circle.

This may impair the vehicle's driving characteristics.

When driving with a vehicle/trailer combination, always adapt your speed to the current road and weather conditions. Drive carefully. Keep a sufficient safe distance.

Comply with the maximum permissible speed of 50 mph (80 km/h) or 62 mph (100 km/h), even in countries in which higher speeds are permitted for vehicle/trailer combinations.

Attach only an approved trailer hitch to your vehicle. Use only a ball neck that has been approved for your vehicle. Further information about availability and installation – including that of the trailer electrics – is available from a qualified specialist workshop.

The trailer hitch is one of the most important vehicle parts for road safety. Comply with the instructions on operation, maintenance and servicing in the manufacturer's operating instructions.

- ⓘ Your vehicle's bumpers are not suitable for installing detachable trailer hitches.

Do not attach any rented trailer hitches or any other detachable trailer hitches to the bumpers.

- ⓘ The height of the ball neck will change depending on the vehicle's load. In this case, use a trailer with a height-adjustable drawbar.

### Driving notes

The maximum permissible speed for vehicle/trailer combinations depends on the type of trailer. Before setting off, consult the trailer's vehicle documents to find out the maximum permissible speed.

Your vehicle will behave differently with a trailer relative to without a trailer, and the high-voltage battery will need to be recharged more quickly.

Observe the notes on ESP® trailer stabilization (→ page 122).

### Driving tips

If the trailer starts to sway, remember the following points:

- Do not accelerate under any circumstances.
- Do not countersteer.
- If necessary, apply the brakes.

- ⓘ You can reduce the risk of the trailer swaying and rocking by retrofitting stabilizer bars or trailer stability programs. You can obtain further information from any authorized Mercedes-Benz Center.

When you are driving with a trailer, observe the following points:

- Maintain a greater distance from the vehicle in front than when driving without a trailer.
- Avoid braking abruptly. If possible, brake gently first of all so that the trailer closes up behind your vehicle. Then, increase the braking force rapidly.

## Coupling/uncoupling a trailer

### Coupling a trailer

**!** **NOTE** Damage to the starter battery due to full discharge

Charging the trailer battery using the power supply of the trailer can damage the starter battery.

▶ Do not use the vehicle's power supply to charge the trailer battery.

- ▶ Shift the selector lever to position **P**.
- ▶ Apply the vehicle's parking brake.
- ▶ Close all the doors.
- ▶ Position the trailer on a level surface behind the vehicle.
- ⓘ The height of the ball neck will change depending on the vehicle's load. In this case, use a trailer with a height-adjustable drawbar.
- ▶ Couple up the trailer.
- ▶ Establish all electrical and other connections to the trailer.
- ▶ Remove objects or devices that are preventing the trailer from rolling (e.g. chocks).
- ▶ Release the trailer's parking brake.
- ⓘ The vehicle sub-harness has a cable connection to the brake light indicator lamp.

Observe the maximum permissible trailer dimensions (width and length).

Most US states and all Canadian provinces prescribe the following points, and you are urgently recommended to comply with these:

- Safety chains between the towing vehicle and the trailer. The chains should be routed in a criss-cross pattern under the drawbar. They must be connected to the trailer hitch and not to the bumper or to the vehicle's axle.  
Leave sufficient slack in the chains. This also allows for sharp cornering.
- A separate brake system is required for certain trailers.
- A safety feature is required for braked trailers. Determine the specific requirements according to the relevant laws.  
If the trailer becomes detached from the towing vehicle, the safety feature triggers the trailer brakes and can thus reduce the danger.

### Uncoupling a trailer

**!** **WARNING** Risk of being crushed and becoming trapped when uncoupling a trailer

When uncoupling a trailer with an engaged inertia-activated brake, your hand may become trapped between the vehicle and the trailer drawbar.

▶ Do not uncouple trailers with an engaged overrun brake.

**!** **NOTE** Damage during uncoupling with an engaged overrun brake

The vehicle may be damaged if you uncouple with an engaged overrun brake.

▶ Do not uncouple trailers with an engaged overrun brake.

- ▶ Shift the selector lever to position **P**.
- ▶ Apply the vehicle's parking brake.
- ▶ Close all the doors.
- ▶ Apply the trailer's parking brake.
- ▶ Further secure the trailer against rolling away with a wheel chock or similar object.
- ▶ Remove the trailer cables and safety chains.
- ▶ Uncouple the trailer.

## Configuring settings for trailer operation

On-board computer:

↳ Settings ▶ eSprinter ▶ Trailer Settings

### Making settings for a trailer

The settings in this menu enable the energy forecast at the start of the trip to be calculated more accurately. The amount of energy, charging station scheduling, charging time and arrival time will thus be calculated to a greater degree of precision.

The selected trailer type influences:

- Navigation with Electric Intelligence
- ECO Assist
- The load spectrum
- ▶ Select the desired trailer type.
- ▶ Select the maximum permissible speed of the selected trailer.
- ▶ Confirm the changes.

- i** When contact with the trailer socket is established (trailer/rear bicycle rack), a menu will automatically appear on the display.

The following selections are available:

- **Rear Luggage Rack**
- **Small trailer**
- **Large trailer**

### Calibrating a trailer coupling

- ▶ Select **Trailer coupling replaced Start calibration?** to begin calibration for the new ball head position.
- ▶ Confirm the changes.
- ▶ Activate Trailer Maneuvering Assist and follow the corresponding instructions on the central display of the instrument cluster. When the **Activated: Trailer Maneuvering Assist** message is displayed, calibration is complete and Trailer Maneuvering Assist can be used.

### Information about towing a trailer

Operating a trailer is subject to many statutory regulations such as maximum permissible speeds.

Many German states require a separate braking system for a trailer when a certain weight limit is exceeded. For your safety, it is recommended to use a separate functional braking system on any towed vehicle.

Make sure that your trailer combination meets local regulations. This not only applies to your place of residence, but also to your destination. Information on this can be obtained from the police and local authorities.

Comply with the following when driving with a trailer:

- Practice cornering, stopping and backing up in a traffic-free location. In this way, you will gain

driving experience and become accustomed to the new handling characteristics.

- Before driving, check the following:
  - that the trailer hitch and ball neck are secure
  - that the safety switch for braked trailers is functioning correctly
  - that the safety chains are secure and undamaged
  - that the electrical connections are secure
  - that the lights are functioning correctly
  - the wheels for damage and correct tire pressure (→ page 188)
- Adjust the outside mirrors so that you have a clear view of the rear section of the trailer.
- If the trailer is equipped with an individual braking system, check before each journey whether the brakes are functioning correctly.
- If the trailer has electronically controlled brakes, pull away carefully with the vehicle/trailer combination. Brake manually using the brake controller and check whether the brakes are functioning correctly.
- Secure the load on the trailer in line with the requirements and rules for load-securing methods.
- When driving with a trailer, check at regular intervals that the load is secure and that the lights and brakes are functioning correctly.
- Bear in mind that the handling characteristics are more unstable when towing a trailer than when driving without a trailer. Avoid sudden steering movements.
- The vehicle/trailer combination is heavier, accelerates more slowly, has a reduced gradeability and an increased braking distance. It is more susceptible to side winds and requires careful steering.
- If possible, do not brake suddenly, but rather moderately at first so that the trailer can activate its brakes. Then increase the pressure on the brake pedal.
- Avoid constant braking, as this could cause the vehicle brakes and possibly also the trailer brakes to overheat.
- If the coolant temperature increases significantly when the air conditioning system is switched on, switch the air conditioning system off.

Coolant heat will also be dissipated if you switch the airflow and the temperature of the heating or air conditioning system to the maximum level. Open the windows if necessary.

- When overtaking, pay particular attention to the increased overtaking distance of your vehicle/trailer combination.

Due to the length of your vehicle/trailer combination, you will require a longer stretch of road before switching back to the original lane.

### Permissible trailer loads and tongue weights

#### Weight information

**⚠ WARNING** Risk of accident due to an unbraked trailer with an excessive gross weight

If you pull an unbraked trailer with a gross trailer weight (GTW) of more than 1,653 lbs (750 kg), the vehicle's brake system may overheat.

This increases the braking distance and may even cause the brake system to fail.

- ▶ Always use a trailer with a separate braking system if you are pulling a gross trailer weight (GTW) of more than 1,653 lbs (750 kg).

**! NOTE** Damage to the drive train, transmission or trailer tow hitch due to excess gross combination weight

The permissible gross combination weight is exceeded.

The drive train, the transmission or the trailer tow hitch may be damaged.

- ▶ Comply with the permissible gross combination weight.

For vehicles with a permissible gross weight of 11030 lbs (5003 kg), the permissible gross combination weight is less than the sum of the permissible gross vehicle weight and the permissible trailer load. If either the vehicle or the trailer is fully laden, the permitted gross vehicle weight or the permitted trailer load values will be reduced accordingly. In this case, you may only partially load the trailer or the vehicle.

The gross trailer weight (GTW) is calculated on the basis of the weight of the trailer plus the weight of its load and equipment. If the trailer is equip-

ped with a separate braking system, then the maximum gross trailer weight is 5000 lbs (2268 kg) or 7500 lbs (3402 kg).

The maximum permissible trailer drawbar nose-weight on the ball head is 500 lbs (227 kg) or 750 lbs (340 kg). However, the actual tongue weight must not exceed the value given on the trailer hitch or trailer identification plates. Where the values differ, the lowest shall always apply.

The gross combined weight rating (GCWR) is calculated on the basis of the gross trailer weight plus the gross vehicle weight, including a driver's weight of approximately 150 lbs (68 kg). The maximum permissible gross combination weight is vehicle-specific and equipment-dependent. When driving with a trailer, you should not exceed the maximum permissible gross combination weight rating (GCWR).

The permissible values, which must not be exceeded, can be found in your vehicle documents and on the identification plates of the trailer hitch, the trailer and the vehicle. The values approved by the manufacturer can also be found in the "Technical data" section. Where the values differ, the lowest shall always apply.

#### Loading the trailer

Use a tongue weight that is as close as possible to the maximum permissible tongue weight. Do not allow the weight to fall below the minimum permissible tongue weight. Otherwise, the trailer may become detached.

- Distribute the load over the vehicle and the trailer so as not to exceed either the maximum permissible values for the gross vehicle weight rating (GVWR) and gross trailer weight (GTW), the gross combination weight rating (GCWR), or the maximum permissible gross axle weight rating (GAWR) and tongue weight (TWR) of your vehicle.
- Add the rear axle load to the drawbar tongue weight (TWR) on the ball head. This will ensure that you do not exceed the permissible gross axle weight rating (GAWR).
- Add the vehicle load to the drawbar tongue weight (TWR) on the ball head. This will ensure that you do not exceed the permissible gross vehicle weight rating (GVWR).

#### Checking vehicle and trailer weight

- Make sure that the weights of the towing vehicle and the trailer comply with the maximum permissible values. Have the vehicle/trailer combination weighed on a calibrated weighing

machine. The vehicle/trailer combination comprises the towing vehicle including driver, passengers and load as well as the laden trailer.

- Check the maximum permissible gross axle weight rating of the front and rear axles (GAWR), the gross trailer weight (GTW), the gross combination weight rating (GCWR) and the drawbar tongue weight (TWR).

### Trailer power supply

Incorrect cabling of the connector plug may interfere with other electronic systems in the vehicle. Mercedes-Benz therefore recommends that you have the cabling of the connector plug carried out at a qualified specialist workshop.

You can connect accessories up to a maximum of 240 W to the permanent power supply. Do not charge a trailer battery using the power supply.

Your vehicle may be equipped with a range of electrical equipment for trailer operation. Depending on your trailer, you may need an adapter for the electrical connection between the trailer and your vehicle.

The trailer socket of your vehicle is equipped with a permanent power supply at the factory.

The permanent power supply is supplied via trailer socket pin 4.

Note that the trailer's permanent power supply is not switched off when the vehicle's on-board electrical system voltage is low. This could completely discharge your vehicle's starter battery.

Further information on the electrical equipment currently installed on your vehicle and on installing the trailer electrics can be obtained at a qualified specialist workshop.

### Notes on the instrument cluster

**⚠ WARNING** Risk of accident due to an instrument cluster malfunction

In the event of a failure or malfunction of the instrument cluster, you will not recognize limitations in the functions of systems relevant to safety. This may impair operating safety.

▶ Park the vehicle safely as soon as possible and notify a qualified specialist workshop.

The instrument cluster shows the following basic information:

- Speed and power meter level
- Range according to average consumption, personal driving style or high-consumption driving style
- State of charge of the high-voltage battery
- Indicator and warning lamps

Additional functions available include the following:

- Different menus, e.g. for assistance and navigation
- Status displays for the driving systems
- Display messages
- Information on speed, consumption and range

### Overview of the instrument cluster

**⚠ WARNING** Risk of accident due to an instrument cluster malfunction

In the event of a failure or malfunction of the instrument cluster, you will not recognize limitations in the functions of systems relevant to safety. This may impair operating safety.

▶ Park the vehicle safely as soon as possible and notify a qualified specialist workshop.

If you are uncertain regarding the operational safety of your vehicle, park the vehicle safely as soon as possible. Inform a qualified specialist workshop.

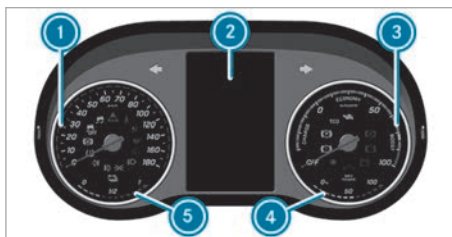

- ① Speedometer
- ② Instrument cluster display (→ page 146)
- ③ Power availability display (→ page 145)
- ④ Maximum available output of the drive system
- ⑤  State of charge of the high-voltage battery (→ page 280)

### Speedometer

In vehicles with Active Distance Assist DISTRONIC, there are illuminated segments on the speedometer dial.

These segments show you what speed range is available:

- Variable limiter activated (→ page 125)  
The segments light up from the start of the scale to the selected limit speed.
- Active Distance Assist DISTRONIC switched on (→ page 126)  
One or two segments light up in the saved speed range.
- Active Distance Assist DISTRONIC detects a vehicle in front.  
The segments light up from the speed of the vehicle in front up to the saved speed.

You can show the speed as a digital speedometer on the display as well.

In some countries, an audible signal will sound and/or a message will appear on the display when the vehicle reaches the maximum speed permitted by law, e.g. at 60 mph (100 km/h).

### Outside temperature display

You should pay special attention to road conditions when temperatures are around freezing point.

The outside temperature is shown on the instrument cluster display (→ page 146).

Changes in the outside temperature will be displayed after a short delay.

### Function of the power availability display

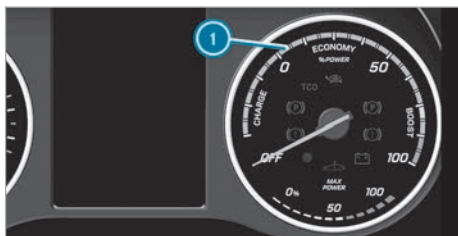

Power availability display (example)

The power availability display ❶ includes two areas:

- In the area below **0**, the recovered power of the vehicle during recuperation is displayed.
- In the area above **0**, the current amount of power that the drive system is feeding to the wheels is displayed.

If the needle for the power availability display is in the **OFF** position, the vehicle is not ready to drive.

The vehicle is not ready to drive in the following situations:

- The drive system has not yet started.
- There is still a charging cable connected to the vehicle socket.
- There is insufficient high-voltage battery power available.
- There is a malfunction in the high-voltage on-board electrical system.

Once the vehicle is ready to drive, the needle moves to the **0** position and the display **READY** appears on the instrument cluster.

The braking effect of the electric motor using recuperation is either reduced or not effective in the following operating statuses:

- The high-voltage battery is not yet at normal operating temperature.
- The road speed is close to vehicle standstill.
- The transmission is in position **N**.
- During or after an ESP® control intervention.

### Operating the on-board computer

**⚠ WARNING** Risk of distraction from information systems and communications equipment

If you operate information systems and communication devices integrated in the vehicle when driving, you could be distracted from the traffic situation. This could also cause you to lose control of the vehicle.

- ▶ Only operate this equipment when the traffic situation permits.
- ▶ If you cannot be sure of this, stop the vehicle whilst paying attention to road and traffic conditions and operate the equipment with the vehicle stationary.

You must observe the legal requirements for the country in which you are currently driving when operating the on-board computer.

#### Scrolling on the menu bar

❶ The indicators for the on-board computer will appear on the instrument cluster display .

When the function is switched on, different signal tones will provide feedback while the on-board computer is being operated. These include a signal tone when the end of a list is reached or when a list is being scrolled through.

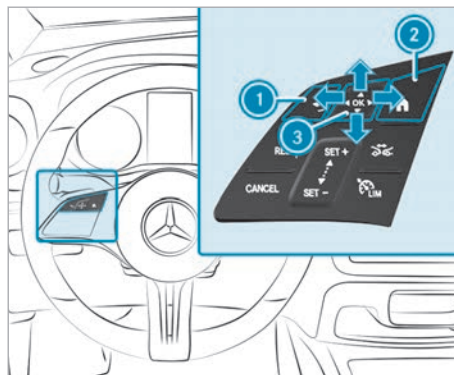







- ❶ Back button
- ❷ Main menu button
- ❸ Touch Control

The on-board computer on the instrument cluster is operated using the controls on the left-hand side of the steering wheel. You can use Touch Control ❸ to navigate vertically and horizontally

by swiping with one finger. Confirm the selection by pressing the Touch Control.

- ① To operate Touch Control ③ in the most effective way, use the tip of your thumb if possible. You can also set the sensitivity of the Touch Control on the media display .
- ▶ Briefly press main menu button ②.
- ▶ Select a menu by swiping to the left or right on Touch Control ③.
- ▶ **To confirm:** press Touch Control ③.

-  Adaptive Highbeam Assist (→ page 74)
-  ATTENTION ASSIST switched off
-  A door is not fully closed.
-  Rear window wiper switched on (→ page 80)
- SOS NOT READY**
-  Emergency call system not active
-  Active Lane Keeping Assist switched off
-  Active Brake Assist switched off

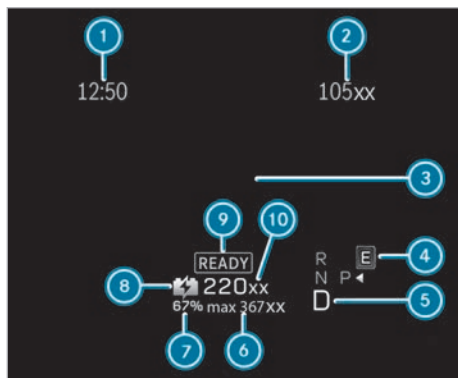

**Overview of instrument cluster display**



Indicators on the display of the instrument cluster (example)



- ① Time
- ② Outside temperature
- ③ Display segment menu (→ page 147)
- ④ Drive program (→ page 104)
- ⑤ Drive range (→ page 105) and recuperation display (→ page 95)
- ⑥ Maximum possible range
- ⑦ State of charge as % (→ page 146)
- ⑧ Charging active
- ⑨  indicator (→ page 97)
- ⑩ Current range, depending on driving style and electrical consumers

Further indicators on the instrument cluster display:

-  Parking Assist PARKTRONIC switched off
-  Cruise control (→ page 125)
-  Active Distance Assist DISTRONIC (→ page 126)

**Function of the charge level display**

Percentage ① indicates the state of charge of the high-voltage battery. In addition, the maximum range is displayed beside it and the current range is displayed above it.

When the drive system is ready for operation  and the **Reserve Level Charge High-Voltage Battery** message appears or the  indicator lamp on the instrument cluster lights up, the state of charge of the high-voltage battery has reached the reserve level.

You can find information about charging the high-voltage battery in the section "Charging the high-voltage battery" (→ page 107).

**Display of the available power**

**⚠ WARNING** Risk of accident due to reduced power of the drive system

If the drive system experiences a power output limitation, there is a risk of accident, particularly when accelerating and overtaking.

- ▶ Adapt your driving style and drive particularly carefully.
- ▶ Charge the high-voltage battery at a charging station immediately.



Display of the maximum available power

In the following operating conditions, the available power may be reduced:

- in very high or low outside temperatures
- if there are very high power requirements over an extended period of time
- if the state of charge of the high-voltage battery is very low
- if there is a malfunction in the drive system

You can improve the reduced power availability by charging the high-voltage battery (→ page 107).

### Warnings in the event of low output

If the drive system had been exposed to very low temperatures, the instrument cluster may show the following warnings once the vehicle has been started:



Displays when drive power is low (example values)

- 1 Alternating display: **Reduced Drive System Performance See Operator's Manual and Reserve Level Charge High-Voltage Battery**
- 2 Maximum range shows xxx miles (xxx km)
- 3 Current range shows xxx miles (xxx km)
- 4 State of charge of the high-voltage battery in % appears in yellow
- 5 High-voltage battery indicator lamp lights up yellow

A warning tone also sounds.

Only around 30 % of the usual drive power is available.

In this case, do not switch on the  windshield defrosting climate control function. Otherwise, the output will decline further.

Charge the high-voltage battery.

### Overview of menus on the on-board computer

Use the left-hand control panel on the multifunction steering wheel button to call up the list of menus and select a menu (→ page 145).

Depending on the vehicle equipment, you can call up the following menus:

- **Service** (→ page 147) menu
- **Assistance** (→ page 147) menu
- **Trip** (→ page 148) menu
- **Settings** (→ page 149) menu

### Menus and submenus

#### Calling up functions on the service menu

On-board computer:

→ **Service**

▶ Select and confirm the desired function.

The following functions are available on the service menu:

- **Announcements:** message memory (→ page 251)
- **Tires:**
  - checking the tire pressure with the tire pressure monitor (→ page 193)
  - restarting the tire pressure monitor (→ page 194)
- **ASSYST PLUS:** calling up the service due date (→ page 166)
- **Operating Hours:** showing operating hours
- **Consumption Info:** overview of long-term consumption

#### Calling up the assistant display (Assistance menu)

On-board computer:

→ **Assistance**

Various driver assistance systems and navigation instructions are shown on the assistant display.

The following displays are available on the **Assistance** menu:

- Assistant display
- Blind Spot Assist

▶ Select the desired display and confirm.



Indicator in the Assistance menu (example)

The following status indicators are available on the assistant display:

- Specified distance for Active Distance Assist DISTRONIC (→ page 126)
- Blind Spot Assist status display (→ page 132)
- Blind Spot Assist on and ready to issue warnings (lines of the radio waves green)
- Blind Spot Assist on and not ready to issue warnings (lines of the radio waves: gray)
- Information about Lane Keeping Assist over the lane marking

### Calling up the Trip menu

On-board computer:



- ▶ Select the desired display and confirm.

The following displays are available on the Trip menu:

- Basic trip display
- Range
- Consumption: current energy consumption
- ECO Display
- From Start
- From Reset
- ATTENTION ASSIST
- Digital speedometer



Standard display (example)

- 1 Trip distance
- 2 Distance unit
- 3 Total distance
- 4 Charging prediction at departure time (only when charging is active and the vehicle status is not READY)

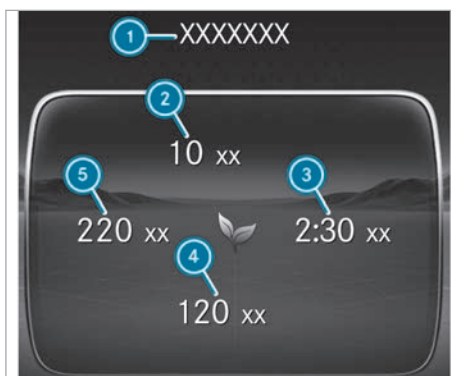

Trip computer display (example)

- 1 From start or from reset
- 2 Average energy consumption (from start or from reset)
- 3 Driving time (from start or from reset)
- 4 Average speed (from start or from reset)
- 5 Distance covered (from start or from reset)



ATTENTION ASSIST display: 15 min since last break

### Resetting values on the trip menu of the on-board computer

On-board computer:

↳ Trip

- ⓘ The wording of the displayed main menu may differ. Therefore, pay attention to the menu overview for the instrument cluster (→ page 145).

You can reset the values of the following functions:

- Trip Distance:
  - Reset Odometer?
- Trip computer:
  - From Start
  - From Reset
- ECO Display

▶ Select the function for which the value is to be reset and confirm this selection.

▶ Confirm the **Reset Values?** prompt with **Yes**.

### Calling up settings on the on-board computer

On-board computer:

↳ Settings

The following entries can be configured on the **Settings** menu:

#### eSprinter

- Selecting **Charging Program**
  - Selecting **Charging Program**
  - Selecting **Max. State of Charge**
  - Switching **ECO Charging**  
**ICON\_Eco\_Charging\_small** on/off
  - Switching **Unlock Charging Cable** on/off
- Selecting **Departure Time**
- Selecting **Settings** 
- Switching **Pre-entry Climate Control at** on/off
- Selecting **Pre-entry Climate Control at**
- Calling up the **Battery Calibration** submenu

#### Assistance

- Calling up the **ESP** ▲ submenu
- Switching **Active Brake Assist** on/off  
Select options if enabled.
- Calling up the **Act. Lane Keeping Assst** ▲ submenu
  - Switching **Act. Lane Keeping Assist** on/off  
Further options available if enabled
  - Switching **Advanced Support** on/off
- Switching **Lane Keeping Assist** on/off
- Switching **Blind Spot Assist** on/off
- Switching **Rear Cross Traff. Warn.** on/off
- Switching **Sideguard Assist Warning** on/off
- Switching **Moving-off Info Assist** on/off
- Calling up the **Active Distance Assist** ▲ submenu
  - Switching **for Speed Limits** on/off
  - Reducing the distance
  - Switching **Route-Based** on/off
- Switching **Active Steering Assist** on/off
- Switching **ECO Assist** ▲ on/off
- Calling up the **ATTENTION ASSIST** ▲ submenu
  - Switching **ATTENTION ASSIST** on/off

Further options available if enabled

- Switching **Distraction Warning** on/off
- Switching **Occupant Presence Rem.** on/off

#### Light

- Switching **Int. Sw.-off Delay Time** on/off
- Switching **Ext. Sw.-off Delay Time** on/off
- Switching **Locator Lighting** on/off

#### Vehicle

- Selecting the **Winter Tire Limit** option
- Switching **Standby Mode** on/off
- Switching **Acoustic Lock** on/off
- Switching **Automatic Locking** on/off
- Selecting the **Rear Air Conditioning** ▲ submenu
  - Selecting the settings for the air-conditioning system
- Selecting the **Rain Sensor** option

#### Heating

- Switching **Departure Time** on/off
  - Further options available if enabled
- Calling up the **Settings** ▲ submenu
  - Selecting your desired **Departure Time**

#### Display and Operation

- Calling up the **Language** submenu
  - Selecting your preferred language.
- Calling up the **Time** ▲ submenu
  - Setting the time.
- Calling up the **Date** ▲ submenu
  - Setting the date.
- Calling up the **Units** ▲ submenu:
  - Switching **Additional Speedometer** on/off
  - Selecting **Speedo./Odometer Unit**
- Calling up the **Operation** submenu:
  - Switching **Acoustic Op. Feedback** on/off
    - Further options available if enabled
  - Switching **Touch Control Sensitivity** on/off

#### Factory Settings

- Calling up the **Factory Settings** submenu
  - ▶ Select an entry and confirm the selection.
  - ▶ Make the necessary changes.

#### Calling up the battery calibration menu

On-board computer:

- ↳ **Settings** ▶ **eSprinter**
- ▶ **Battery Calibration**

The menu indicates whether the high-voltage battery needs to be calibrated.

- ▶ Observe the notes on calibrating the high-voltage battery (→ page 166).
  - ▶ Confirm the selection of **Perform Calibration** and carry out a normal or a special calibration (→ page 167).
- or
- ▶ Exit the menu without confirming.

#### Adjusting the instrument lighting

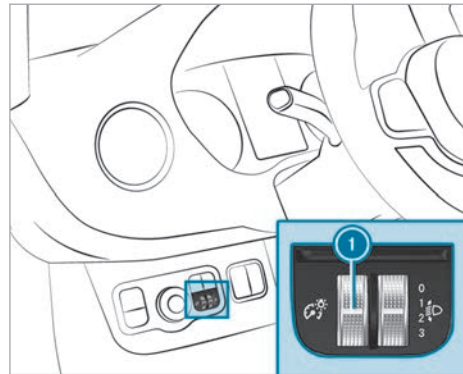

- ▶ Turn brightness control ① upwards or downwards. The lighting of the instrument cluster and the controls in the vehicle interior will be adjusted.

## Mercedes-Benz Connect calls

### Making Mercedes-Benz Connect calls via the overhead control panel

- ① Mercedes-Benz Connect calls are not available in all countries. Contact an Mercedes-Benz to find out whether these functions are available in your country.
- ② Please note that product scopes can vary depending on the model series, year of production and equipment, as well as between private and commercial user accounts.

The following Digital Extras are not time-limited:

- Accident and Breakdown Management
- Maintenance management
- Telediagnosics

Other Digital Extras can be extended at the end of the initial term for a fee. The first activation of the Digital Extras is possible within one year of initial registration or commissioning by the customer, depending on which occurs first.

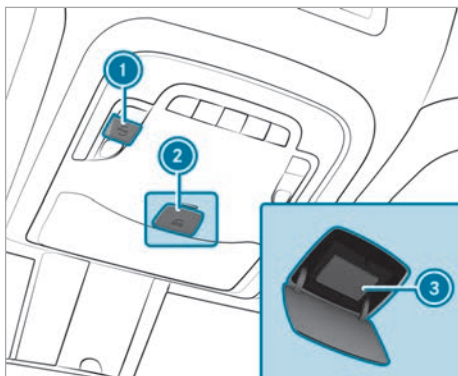

- ① me button for Mercedes-Benz Connect calls
- ② SOS button cover
- ③ SOS button (emergency call system)

### Making a Mercedes-Benz Connect call

- ▶ Press button ①.

### Making an emergency call

- ▶ Briefly press the cover on SOS button ② to open it.
- ▶ Press and hold SOS button ③ for at least one second.

If a Mercedes-Benz Connect call is active, an emergency call can still be initiated. This has priority over all other active calls.

### Information on the Mercedes-Benz Connect call via the overhead control panel

A Mercedes-Benz Connect call to the Mercedes-Benz Customer Center was initiated using the me button in the overhead control panel (→ page 151).

You can reach the desired service via the voice dialog system:

- Accident and Breakdown Management
- Mercedes-Benz Customer Center for general information about the vehicle

You can find information on the following topics:

- Activation of Digital Extras
- Operating the vehicle
- Nearest authorized Mercedes-Benz Center
- More products from Mercedes-Benz

Data is transmitted during the connection to the Mercedes-Benz Customer Center (→ page 152).

### Arranging a service appointment via a Mercedes-Benz Connect call

If you have activated the Service Management Digital Extra, relevant vehicle data is automatically sent to the Mercedes-Benz Customer Center. You will then receive individual recommendations regarding the maintenance of your vehicle. You will receive an offer for the upcoming maintenance scopes from the service partner stored in your user account.

Regardless of whether you have consented to the maintenance management service, you are reminded in the instrument cluster after a certain amount of time that a service is due.

- ▶ **To arrange a service appointment:** select the me button in the overhead control panel (→ page 151).

You will be guided through the speech dialog and, if necessary, you will be forwarded to an appropriate specialist.

After your confirmation, the vehicle data is sent and the Mercedes-Benz Customer Center deals with your appointment. The information is then sent to your desired service outlet.

- They will contact you to confirm the appointment and, if necessary, to discuss the details.
- ❶ No request for consent to data transmissions takes place if the Accident Recovery and Breakdown Management Digital Extras are activated.

### Data transmitted during a Mercedes-Benz Connect call

If you initiate a call via Mercedes-Benz Connect, data will be transferred. This enables targeted advice and smooth service.

The following requirements must be met for the data transfer:

- The vehicle is switched on.
- The necessary data transmission technology is supported by the mobile phone network provider.
- A sufficient mobile phone connection quality is provided.

Multi-stage transmission depends on the following factors:

- Reason for the initiation of the call
- Available mobile radio transmission technology
- Activated Digital Extras
- Selected service in the voice dialog system
- ❶ A prompt for consent to data transmission is only made if the corresponding Digital Extra has not been activated.
- ❷ The scope of the transmitted data depends on the vehicle model and equipment. For technical reasons not all data is available at all times.
- ❸ The prompt to confirm data transfer does not appear in all countries.

### Data transmission when Digital Extras are not activated

If no Digital Extras are activated and the data protection prompt has been confirmed, the following data are transmitted:

- Vehicle identification number
- Time of the call
- Reason for the initiation of the call
- Confirmation of the data protection prompt

- Vehicle country code
- Call number of the communication platform installed in the vehicle

If a call is made for a service appointment via the service reminder, the following data is also transmitted:

- Current mileage and maintenance data

If Accident Recovery and Breakdown Management is selected using the voice dialog system and no Digital Extra is activated, but the data protection request has been confirmed, the following data may additionally be requested from the vehicle by the Mercedes-Benz Customer Center:

- Current vehicle location

If the data protection request has been declined, the following data will be transferred to enable targeted advice and a smooth service:

- Time of the call
- Reason for the initiation of the call
- Rejection of the data protection prompt
- Vehicle country code
- Call number of the communication platform installed in the vehicle

### Data transmission when Digital Extras are activated

Only in the second step and only for the respective activated Digital Extras, further case-specific data is transmitted in order to enable an optimal service.

An overview of the data transmitted can be found in the respective terms of use for Digital Extras. You can obtain these in the Mercedes-Benz Portal: <https://www.mercedes.me>

### Data processing

The data transmitted as part of the call will be deleted from the transmitting systems once the call has been completed, provided they are not used for other activated Digital Extras.

The case-related data will be processed and stored in the Mercedes-Benz Customer Center and, if necessary for case processing, forwarded to the service partners commissioned by the Mercedes-Benz Customer Center. Please refer to the data protection information for Digital Extras either on the Mercedes-Benz website at <https://www.mercedes.me> or in the pre-recorded message which you hear at the beginning of the call to the Mercedes-Benz Customer Center.

- ❗ The recorded message is not available in every country.

## Mercedes-Benz Connect

### Information on Mercedes-Benz Connect

- ❗ Please note that product scopes can vary depending on the model series, year of production and equipment, as well as between private and commercial user accounts.

Mercedes-Benz Connect comprises a number of Digital Extras.

Using the multimedia system or the overhead control panel, if available, you can use the following Digital Extras, for example:

- Accident Recovery (button in the overhead control panel)
- Breakdown Management (button in the overhead control panel)
- Emergency call system (automatic emergency call and SOS button)

The Accident Recovery and Breakdown Management Digital Extras and the Mercedes-Benz emergency call center are available to you around the clock.

The me button and the SOS button can be found on the vehicle's overhead control panel (→ page 151).

If the multimedia system is available in the vehicle, you can also call the Mercedes-Benz Customer Center using the multimedia system .

Please note that Mercedes-Benz Connect is a Mercedes-Benz service. In emergencies, call the national emergency services first using the standard national emergency service phone numbers. In emergencies, you can also use the emergency call system (→ page 178).

Please observe the terms of use and data protection notes for Digital Extras. You can find these in your Mercedes me user account.

You can find more information on Mercedes-Benz Connect and Digital Extras in the Mercedes-Benz portal: <https://me.secure.mercedes-benz.com>

### Information on Accident and Breakdown Management Digital Extras

- ❗ The Accident and Breakdown Management Digital Extras are not available in all countries. Contact an authorized Mercedes-Benz Center

to find out whether this function is available in your country.

The Accident and Breakdown Management can, amongst others, include the following functions:

- Supplement to the Emergency Call System (→ page 178)

If necessary, the contact person at the Mercedes-Benz emergency call center forwards the call to Accident and Breakdown Management. However, call forwarding is not possible in all countries.

- Breakdown assistance on location by a technician and/or towing away of the vehicle to the nearest Mercedes-Benz

You may be charged for these services.

- In the event of a breakdown or accident, extended vehicle data is sent, enabling optimum support from the Mercedes-Benz Customer Center and the appointed service partner or breakdown mechanic.
- If available: Supplement to the Telediagnosis Digital Extra

With the Telediagnosics function, specific wear and failure reports are recorded by the service provider, in so far as these can be clearly interpreted and are available through the monitoring of components that are subject to diagnostics.

- ❗ These services are subject to technical restrictions such as mobile coverage and mobile network quality and the interpretability of the transmitted data in the processing systems. Under certain circumstances, this may result in delays or omission of the message in the instrument cluster.

Please note that Mercedes-Benz Connect Call is a Mercedes-Benz service. In the event of an emergency always call the national emergency services first or use the Mercedes-Benz emergency call system (→ page 177).

You can find more information on Digital Extras in the Mercedes-Benz Portal: <https://www.mercedes.me>

### Data transmitted with Mercedes-Benz Connect

The data transferred during a Mercedes-Benz Connect call depends on:

- The reason for the initiation of the call
- The service selected in the voice dialog system
- The Digital Extras which are activated (→ page 152)

You can ascertain which data is transferred in conjunction with Digital Extras by consulting the currently valid terms of use and data protection notes for Digital Extras. You can find these in your Mercedes me user account.

### **MB Apps (Digital Extras)**

#### Information on MB Apps/Digital Extras

##### **Requirements:**

- To use the Digital Extras, registration must have been carried out in the Mercedes-Benz portal.
- You must have agreed with the terms of use for Digital Extras.
- The Digital Extras must be activated.  
The Digital Extras can be activated in the Mercedes-Benz Portal via the path [Manage vehicle](#) > [My services](#).

With a Mercedes me ID user account you have access to Mercedes-Benz services and offers.

- ① Please note that product scopes can vary depending on the model series, year of production and equipment, as well as between private and commercial user accounts.

Availability is country-dependent.

Further information can be obtained from an authorized Mercedes-Benz Center or in the Mercedes-Benz Portal: <https://me.secure.mercedes-benz.com>

### Notes on operating safety

**⚠ WARNING** Risk of distraction from operating integrated communication equipment while the vehicle is in motion

If you operate communication equipment integrated in the vehicle when driving, you could be distracted from the traffic situation. This could also cause you to lose control of the vehicle.

- ▶ Only operate this equipment when the traffic situation permits.
- ▶ If you cannot be sure of this, stop the vehicle whilst paying attention to road and traffic conditions and operate the equipment with the vehicle stationary.

You must observe the legal requirements for the country in which you are currently driving when operating the audio system.

**⚠ WARNING** Risk of accident or injury due to incorrect modifications on electronic component parts

Modification of electronic components, their software or wiring could impair their function and/or the function of other networked component parts or safety-relevant systems.

This can endanger the operating safety of the vehicle.

- ▶ Never tamper with the wiring and electronic component parts or their software.
- ▶ You should have all work on electrical and electronic components carried out at a qualified specialist workshop.

Observe the following information when using the radio:

- Observe the safety notes in this manual.
- Observe the road traffic regulations.

### Anti-theft protection

This device is equipped with technical provisions to protect it against theft and cannot be used in another vehicle.

## Overview and operation

### Audio system overview

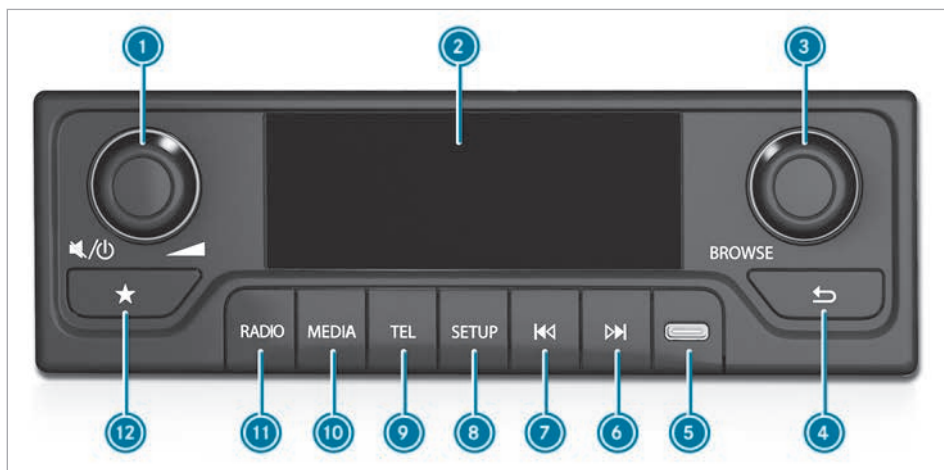

- 1** Control knob  
 Turn: sets the volume  
 Press briefly: switches sound off.  
 Press and hold: switches the audio system on/off.  
 If the media source is switched on: pause or playback
  - 2** Three-line display
  - 3** Control knob  
 Turn: opens the station or media list.  
 Marks the next or previous menu entry.  
 Press briefly: calls up the station list or track list, selects a menu entry or accepts a call.
  - 4** Back  
 Press briefly: moves up one menu or folder level.  
 Press and hold: calls up the main menu for the application.
  - 5** USB-C port
  - 6** Press briefly: next station or skips forwards a track  
 Press and hold: station search function forwards or fast forward
  - 7** Press briefly: previous station or skips back a track  
 Press and hold: station search function backwards or fast rewind
  - 8** Press briefly: calls up system settings.  
 Press and hold: calls up radio text or ID3 tag.
  - 9** Press briefly: calls up the telephone, accepts or ends a call.  
 Press and hold: calls up the call list.
  - 10** Calls up USB mode, iPod® mode or Bluetooth® audio mode.  
 Requirement: the media source is connected with the audio system.
  - 11** Press briefly: calls up radio in the order FM - DAB - AM (if DAB is available) or FM - AM  
 Press and hold: updates the DAB station landscape (if DAB is available).
  - 12** Press briefly: calls up station presets.  
 Press and hold: saves a station in the open station presets.  
 Alternative: with the station presets open press and hold **3**.
- i Note for 5:** only use a USB-C to Lightning cable certified by Apple® to connect an iPod®.

#### Switching the audio system off/on

- ▶ Press and hold the left control knob.  
 Depending on its status the audio system is activated or deactivated.

#### Adjusting the volume

- ▶ **To increase volume:** turn the volume control clockwise.

- ▶ **To decrease volume:** turn the volume control counter-clockwise.
- ▶ **To mute:** press the volume control.

## System settings

### Audio settings

#### Setting the sound

Audio system:

↳ SETUP ▶ Audio settings ▶ Sound

#### Equalizer

- ▶ Select **Bass**, **Middle** or **Treble**.
- ▶ Change the settings.

#### Balance and fader

- ▶ Select **Balance** or **Fader**.
- ▶ Change the settings.

#### Reset audio settings

Audio system:

↳ SETUP ▶ Audio settings

▶ Reset audio settings

- ▶ Confirm with **YES**.  
The audio settings are reset.

### Setting the time format

Audio system:

↳ SETUP ▶ Clock

- ▶ Select **am/pm** or **24h**.

### Resetting the audio system to the factory settings

Audio system:

↳ SETUP

- ▶ Select **Factory settings**.
- ▶ Confirm the prompt with **Yes**.  
The settings are reset to the factory settings.

### Showing the software version

Audio system:

↳ SETUP

- ▶ Select **Software Version**.  
The current software version is displayed.

## Radio

### Setting the frequency band

Audio system:

↳ RADIO

- ▶ Press the **RADIO** button repeatedly until the desired transmission range is set.

The transmission range changes in this order: FM - DAB.

- ⓘ The DAB transmission range is not available in all countries.

### Selecting a radio station

Audio system:

↳ RADIO

#### Setting a station using the frequency

- ▶ Press the **▶▶** or **◀◀** button to change the frequency.

- ⓘ **Press briefly:** the next or previous station is set.  
**Press and hold:** scrolls step-by-step through the frequencies.

#### Setting a station from the station list

- ▶ Press or turn the right-hand side control knob. The station list is shown.
- ▶ Select a station. The station is set.

#### Selecting stations via the station presets

- ▶ Call up the station presets (→ page 156).
- ▶ Select a station. The station is set.

### Saving stations as favorites

#### Requirements:

- DAB or FM is set as the transmission range (→ page 157).

Audio system:

↳ RADIO

- ▶ Set a station.
- ▶ Press the **☆** button. The station presets are shown.
- ▶ Select a position, then press and hold **☆** or the right control knob. The station selected is saved.

### Activating/deactivating the traffic information service

Audio system:

↳ SETUP ▶▶ Radio Settings ▶▶ TA

When the function is switched on a traffic announcement will interrupt the currently activated radio or media source.

- ▶ Select ON or OFF.

### Setting DAB traffic information

Audio system:

↳ SETUP ▶▶ Radio Settings

▶▶ DAB traffic information

- ▶ Select one or more settings.

- ▶  The DAB transmission range is not available in all countries.

### Selecting Intellitext™

Requirements:

- DAB is set as the station range (→ page 157).

Audio system:

↳ SETUP ▶▶ Radio Settings

▶▶ DAB Settings ▶▶ Intellitext™

If the respective station supports Intellitext™, you can have additional information shown such as news, weather information and sports alerts. This assumes that the broadcasting organization provides such information.. Intellitext™ is only available in some countries.

- ▶ Select a category, for example:
  - News
  - Weather
  - Sports

If the **News** category is selected, three sub-categories can be selected:

- ▶ Select **Business**, **Politics** or **Health**. Intellitext™ for the category selected is shown.

### Showing the current program preview (EPG)

Requirements:

- DAB is set as the transmission range (→ page 157).

Audio system:

↳ SETUP ▶▶ Radio Settings

▶▶ DAB Settings ▶▶ EPG

- ▶ Select a station. The program preview is shown for this station.
- ▶ Press the left control knob. The program preview is shown.

### Media

#### Starting playback of a USB device

Requirements:

- A USB device is connected to the audio system.

Audio system:

↳ 

- ▶ Press the  button repeatedly until the USB is the active media source.
- ▶ Press or turn the left control knob.
- ▶ Select a folder.
- ▶ Select a track. Playback starts.



#### Starting playback of Bluetooth® audio devices

Requirements:

- Bluetooth® is switched on
- A Bluetooth® audio device is connected with the audio system (→ page 160).

Audio system:

↳ 

- ▶ Press the  button repeatedly until Bluetooth® is the active media source.
- ▶ Press or turn the left control knob.
- ▶ Select **Playlists**, **Artists** or **Albums**.
- ▶  These categories are not available for the iPhone®.
- ▶ Select a track. Playback starts.

## Starting playback of an iPod®

### Requirements:

- An iPod® is connected to the audio system.

- ① Only use a certified USB-C to Lightning cable to connect an iPod®.

Audio system:



- ▶ Press the **MEDIA** button repeatedly until iPod® is the active media source.
- ▶ Press or turn the left control knob.  
The following categories are displayed:
  - **Playlists**
  - **Artists**
  - **Albums**
  - **Tracks**
- ▶ Select a category.
- ▶ Select a track.  
Playback starts.

## Showing track information

### Requirements:

- Playback from a USB device is active.

Audio system:



- ▶ Press and hold the **SETUP** button.  
Information on albums, artists and track names is shown.

## Controls playback

### Requirements:

- Playback from a USB device or Bluetooth® audio equipment is active.

- ▶ **To select the next track:** press **▶▶**.
- ▶ **To select the previous track :** press **◀◀**.
- ① If the current track has already been playing for more than eight seconds then you will skip back to the beginning of the track.
- ▶ **To pause playback:** press the left control knob.
- ▶ **To fast forward/rewind:** press the **◀◀** or **▶▶** button until the desired position is reached.

## Setting playback options

Audio system:

➔ **SETUP** ➔ **Audio settings** ➔ **Play Mode**

### Activating/deactivating random playback

- ▶ Select **Mix**.  
Depending on its previous status the function is activated/deactivated.

### Switching repeat on/off

- ▶ Select **Repeat**.  
The following settings are possible:
  - **OFF:** No repetition.
  - **ALL:** The complete playlist is repeated.
  - **ONE:** The current track is repeated.
- ▶ Press repeatedly until the desired setting is reached.

## Telephone

### Telephony

#### Notes on telephony

- ⚠ **WARNING** Risk of distraction from operating integrated communication equipment while the vehicle is in motion

If you operate communication equipment integrated in the vehicle when driving, you could be distracted from the traffic situation. This could also cause you to lose control of the vehicle.

- ▶ Only operate this equipment when the traffic situation permits.
- ▶ If you cannot be sure of this, stop the vehicle whilst paying attention to road and traffic conditions and operate the equipment with the vehicle stationary.

- ⚠ **WARNING** Risk of accident from operating mobile communication equipment while the vehicle is in motion

Mobile communication devices distract the driver from the traffic situation. This can also cause the driver to lose control of the vehicle.

- ▶ As a driver, only operate mobile communication devices when the vehicle is stationary.
- ▶ As a vehicle occupant, use mobile communication devices only in the designa-

ted area, e.g. in the rear passenger compartment.

You must observe the legal requirements for the country in which you are currently driving when operating mobile communication equipment in the vehicle.

Further information can be obtained from an Mercedes-Benz or at: <https://www.mercedes-benz.com/connect>

### ■ Activating/deactivating Bluetooth®

Audio system:



- ▶ Select **Bluetooth**.

#### Activating

- ▶ Select **ON**.

#### Deactivating

- ▶ Select **OFF**.

### ■ Switching on visibility of the audio system

#### Requirements:

- Bluetooth® is activated on the audio system.

Audio system:



- ▶ Select **Make visible**.

### ■ Connecting a mobile phone

#### Requirements:

- Bluetooth® is activated on the mobile phone (see the manufacturer's operating instructions).
- Bluetooth® is activated on the audio system.
- The visibility of the mobile phone is switched on (see the manufacturer's operating instructions).
- The visibility of the audio system is switched on.

Audio system:



#### Authorization using Secure Simple Pairing

- ▶ Select a mobile phone.  
A code is displayed on the audio system and on the mobile phone.
- ▶ **If the codes match:** select **YES** on the audio system.
- ▶ Confirm the code on the mobile phone.

### ■ Switching mobile phones

#### Requirements:

- At least two mobile phones are authorized on the audio system.

Audio system:



- ▶ Select a mobile phone.

### ■ Adjusting the call/ringtone volume

Audio system:



- ▶ Select **Volume**.
- ▶ Set the volume for **Ringtone** or **Call**.

### ■ Setting the ringtone

Audio system:



- ▶ Select **Ringtone**.
- ▶ Set the ringtone for **Car** or **Phone**.

### ■ Disconnecting a mobile phone

Audio system:



- ▶ Select a mobile phone.
- ▶ Select **Yes**.

## Calls

### ■ Telephone operation

Audio system:



#### Making a call

- ▶ Select **Dial Number**.
- ▶ Enter a number.
- ▶ Select .  
The call is made.
- ⓘ You can also make a call using the call list or the phone book.

#### Accepting a call

- ▶ Select .
- or
- ▶ Briefly press button .

#### Rejecting a call

- ▶ Select .
- or
- ▶ Press and hold the button.

## ■ Activating functions during a call

### Ending a call

▶ Select .

or

▶ Briefly press the **TEL** button.

### Transferring a call to the mobile phone (private mode)

▶ Select .

### Sending DTMF tones

▶ Select .

▶ Enter the numbers.

### Adjusting the volume

▶ Set the volume using the control knob (→ page 156).

## ■ Accepting/rejecting a waiting call

### Requirements:

- There is an active call (→ page 160).

If you receive a call while already in a call, a message is displayed.

▶ **To accept:** select .

The incoming call is active. The previous call is on hold.

▶ **To reject:** select .

▶ **To select a call:** select  (1) or  (2).

**i** This function and behavior depends on your mobile phone network provider and the mobile phone (see the manufacturer's operating instructions).

## Phone book

### ■ Downloading mobile phone contacts manually

Audio system:

→ **TEL** → **Settings**

The function is also available. When connecting the mobile phone with the audio system, contacts are downloaded automatically.

▶ Select **Phonebook download**.

### ■ Searching for contacts in the phone book

Audio system:

→ **TEL** → **Phonebook**

▶ Select the contact.

Several phone numbers can be shown for contacts.

## Call list

### ■ Making a call from the call list

Audio system:

→ **TEL** → **Call Lists**

Within the call list the following entries are available for selection:

- **Dialled calls**
- **Received calls**
- **Missed calls**

▶ Select an entry.

The stored calls are shown.

▶ Select an entry.

The call is made.

**i** Alternatively, you can call up the call list by pressing and holding the **TEL** button.

### Notes on loading guidelines

#### **⚠ WARNING** Risk of injury from unsecured objects in the vehicle

When objects are unsecured or inadequately secured, they can slip, tip over or be thrown about, striking vehicle occupants.

This also applies to:

- Luggage or loads
- Seats which have been removed and are being transported in the vehicle in an exceptional case

There is a risk of injury, particularly in the event of braking maneuvers or abrupt changes in direction.

- ▶ Always stow objects in such a way that they cannot be tossed about.
- ▶ Before traveling, secure objects, luggage or load to prevent them slipping or tipping over.
- ▶ When a seat is removed, keep it preferably outside the vehicle.

#### **⚠ WARNING** Risk of injury due to objects being stowed incorrectly

If objects in the vehicle interior are stowed incorrectly, they may slide or be thrown around and hit vehicle occupants. In addition, cup holders, open stowage spaces and mobile phone receptacles will not always be able to retain all objects that they contain in the event of an accident.

There is a risk of injury, particularly in the event of braking maneuvers or abrupt changes in direction.

- ▶ Always stow objects such that they cannot be thrown around in such situations.
- ▶ Always make sure that objects do not protrude from stowage spaces, parcel nets or stowage nets.
- ▶ Close the lockable stowage spaces before starting a journey.
- ▶ Stow and secure objects that are heavy, hard, pointed, sharp-edged, fragile or too large in the cargo compartment.

If you are using a roof luggage rack, please note the maximum roof load and the maximum load capacity of the roof luggage rack. (→ page 249)

Camera-based driving systems and the sensor functions of the inside rear-view mirror may be impaired if you are transporting a load on the roof and it protrudes more than 16 in (40 cm) over the front edge of the roof. Therefore, make sure that the load does not protrude by more than 16 in (40 cm).

The handling characteristics of your vehicle are dependent on the load distribution.

Therefore, please observe the following notes when loading:

- When transporting a load, never exceed the gross vehicle weight rating or the gross axle weight rating for the vehicle (including occupants). The figures are specified on the vehicle identification plate on the B-pillar.
- The load must not protrude above the upper edge of the seat backrests.
- If possible, always transport the load in the load compartment.
- Fasten the load to the cargo tie-down rings and distribute the load evenly among them.
- Use cargo tie-down rings and fastening materials which are suitable for the weight and size of the load.

### Notes on distributing the load within the vehicle

#### **!** NOTE Damage to the floor covering due to uneven loading

Excessive point loading on the cargo compartment floor or on the load area can negatively affect the driving characteristics and could damage the floor covering.

- ▶ Distribute the load evenly. When doing so, ensure that the overall center of gravity of the load is always as low and close to the center as possible and between the axles near the rear axle.

Observe the following notes:

- always transport loads in the cargo compartment.
- always additionally secure the load with suitable load securing aids or lashing material.

## Securing loads

### Notes on load securing

**⚠ WARNING** Risk of accident and injury due to incorrect use of the lashing straps

The following can occur:

- The tie-down eyes may detach or the lashing strap may tear if the permissible load is exceeded
- The load cannot be restrained

The load can slip, tip over or be flung about, striking vehicle occupants.

- ▶ Always tension the lashing straps in the proper manner and only between the described tie-down eyes.
- ▶ Always use lashing straps designed specifically for the loads.

- i** Observe the information relating to the maximum loading capacity of the individual cargo tie-down points. If you combine various cargo tie-down points to secure a load, always take the maximum loading capacity of the weakest cargo tie-down point into account. During maximum full-stop braking, forces may act which can multiply the weight of the load. Always use several cargo tie-down points to distribute the load. Spread the load evenly between the cargo tie-down points or tie-down eyes.

Observe the Operating Instructions or the lashing strap manufacturer's instructions for the operation of the lashing strap.

Observe the information relating to the maximum loading capacity of the cargo tie-down points (→ page 249).

As the driver, you are responsible for ensuring the following:

- The load is secured against slipping, tipping, rolling or falling off.  
Take usual traffic conditions as well as swerving or full brake application and bad roads into account.
- The applicable requirements and guidelines relating to load-securing practices are met.  
If this is not the case, this may constitute a punishable offense, depending on local legislation and any ensuing consequences. Observe country-specific laws.

Make sure that the load is secure before every journey and at regular intervals during a long journey. Adjust the load securing as necessary. Information on how to secure loads correctly can be obtained from the manufacturers of the load securing aids or tie downs for load securing, for example.

When securing loads, observe the following:

- Fill spaces between the load and the cargo compartment walls or wheel wells. For this purpose, use rigid load securing aids, such as chocks, wooden fixings or padding.
- Attach secured and stabilized loads in all directions.

Use the cargo tie-down points or tie-down eyes and the loading rails in the cargo compartment.

Only use tie downs, such as lashing rods, lock rods or lashing nets and lashing straps, which have been tested in accordance with current standards (e.g. DIN EN). Always use the cargo tie-down points closest to the load and pad sharp edges.

Loads, and heavy loads in particular, should preferably be secured using the tie-down eyes.

- i** You can obtain tie downs tested in accordance with current standards (e.g. DIN EN) from any specialist company or from a qualified specialist workshop.

### Notes on the partition

Without a partition, vehicles that are approved as commercial vehicles (vehicle category N1, N2) do not fulfill standard ISO 27956, which describes the equipment for properly securing a load in delivery vehicles. If the vehicle is used to transport goods, retrofitting the partition is strongly recommended, as properly securing the load in vehicles without a partition will always be a complex operation.

- i** Nothing may be stowed in the area between the rear side of the seats and the partition.

### Overview of cargo tie-down point

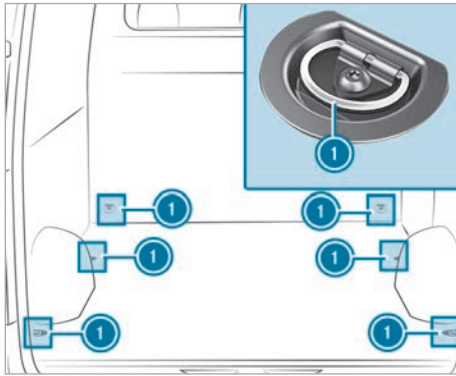

Cargo tie-down points (example: cargo van without loading rails)

#### ① Cargo tie-down rings

Secure loose loads with an approved lashing net or a tarp.

Always fasten the lashing net or tarp to all available cargo tie-down points. Make sure that the fastening hooks are secured against accidental opening.

If your vehicle is equipped with loading rails in the cargo floor, you can place lashing rods directly in front of and behind the load. The lashing rods directly absorb the potential shifting forces.

Securing loads on the cargo floor by lashing them down is recommended only for lightweight loads. Lay anti-slip mats under the load to assist in securing it.

### Installing and removing cargo tie-down rings

▶ **To install:** slide the cargo tie-down ring through a recess in the loading rail close to the load until the locking mechanism engages in the recess.

① When you pull the locking mechanism up and out of the recess, the cargo tie-down ring is able to move within the loading rail. Make sure that the locking mechanism is always engaged in a recess.

▶ Check the cargo tie-down ring for firm seating.

▶ **To remove:** pull the locking mechanism up and pull the cargo tie-down ring towards the locking mechanism and out of the loading rail through a recess.

### Carrier systems

#### Information on the roof luggage rack

⚠ **WARNING** Risk of injury if maximum roof load is exceeded

The vehicle center of gravity and the usual driving characteristics as well as the steering and braking characteristics will change.

If you exceed the maximum roof load, the handling as well as steering and braking characteristics are severely affected.

▶ Always comply with the maximum roof load and adjust your driving style.

⚠ **NOTE** Vehicle damage due to failure to observe the maximum permissible clearance height

If the vehicle height exceeds the maximum permissible clearance height, the roof and other vehicle parts may be damaged.

▶ Please observe the maximum clearance height indicated.

▶ If the vehicle exceeds the permissible clearance height, do not drive in.

▶ Take the modified vehicle height into account in the case of roof superstructures or other carrier systems.

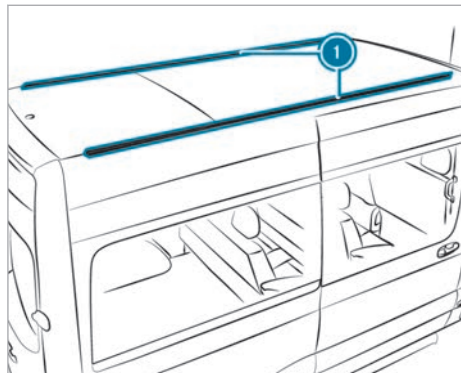

#### ① Mounting rails

Information about the maximum roof load can be found in the "Technical data" section (→ page 249).

Observe the following points for installing roof luggage racks:

- Tighten the screws of the roof luggage rack to a torque of 6.0 lb-ft (8 Nm) – 7.4 lb-ft (10 Nm) in the designated sliding blocks.
- The tightened screws should not touch the rails.
- Ensure that the sliding blocks are not located in the areas around the plastic caps.
- The sliding blocks must have the right cross-section.
- The insides of the mounting rails must be free of dirt.
- Re-tighten the screws uniformly after around 300 miles (500 km).

Mercedes-Benz recommends that you use only roof luggage racks that have been tested and approved for Mercedes-Benz. These will help to prevent vehicle damage.

Have mounting rails retrofitted only at a qualified specialist workshop. Otherwise, you could damage the vehicle.

If your vehicle is equipped with mounting rails on the roof, you can install a roof luggage rack on the roof. Special mounting elements (sliding blocks) are available as accessories for this purpose.

These mounting elements are available from any authorized Mercedes-Benz Center.

**i** A wheel arch may be subjected to a load of 330 lb (150 kg).

### Placing a load on the wheel arch

Comply with the important safety notes under "Notes on loading" (→ page 162).

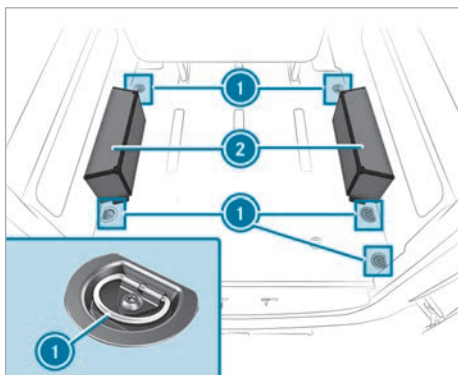

- Place the objects on wheel arch **2** and lash them using tie-down eyes **1** (→ page 164).

## ASSYST PLUS service interval display

### Function of the ASSYST PLUS service interval display

The ASSYST PLUS service interval display on the instrument cluster provides information on the remaining time or distance before the next service due date.

You can hide this service message by using the back button on the left-hand side of the steering wheel.

You can obtain further information concerning the servicing of your vehicle from a qualified specialist workshop, e.g. an authorized Mercedes-Benz Center.

### Displaying the service due date

On-board computer:

➔ Service ➔ ASSYST PLUS

The next service due date is displayed.

▶ **To exit the display:** press the back button on the left-hand side of the steering wheel.

Bear in mind the following related topic:

- Operating the on-board computer (→ page 145)

### Have service work carried out regularly

**!** **NOTE** Premature wear through failure to observe service due dates

Maintenance work which is not carried out at the right time or incompletely can lead to increased wear and damage to the vehicle.

- ▶ Adhere to the prescribed service intervals.
- ▶ Always have the prescribed maintenance work carried out at a qualified specialist workshop.

### Special service requirements

The prescribed service interval is based on normal vehicle use. Perform maintenance work more often than prescribed if the vehicle is operated under arduous operating conditions or increased loads.

Examples of arduous operating conditions:

- Frequent operation in mountainous terrain or on poor road surfaces
- Operation in particularly dusty conditions and/or if air-recirculation mode is frequently used

In these or similar operating conditions, have the interior air filter, for example, changed more frequently. Check the tires more frequently if the vehicle is operated under increased stress. You can obtain further information at a qualified specialist workshop.

### Non-operational times with the battery disconnected

**The ASSYST PLUS service interval display can calculate the service due date only when the battery is connected.**

▶ Display and note down the service due date on the instrument cluster before disconnecting the battery (→ page 166).

## Calibrating the high-voltage battery

### Notes on calibrating the high-voltage battery

Your vehicle's high-voltage battery is equipped with LFP technology (lithium iron phosphate). In comparison to NMC (nickel manganese cobalt), this technology is characterized by a particularly long service life and environmental safety.

In order to provide the most accurate range display, charging time prediction and charge level display, LFP technology requires regular calibrations of the high-voltage battery.

Two types of calibration are required for an accurate calibration of the high-voltage battery:

- A regular normal calibration of the state of charge of the high-voltage battery. This takes place during the process of fully charging the high-voltage battery (→ page 109).
- A special calibration of the high-voltage battery. This is used to determine the age-related battery capacity, ideally twice a year. Among other things, the special calibration requires the high-voltage battery to be charged from a low state of charge (→ page 167).

A special calibration can also be performed manually (→ page 168).

## Calibrating the high-voltage battery

### Requirements:

- There is enough time and space to completely charge the high-voltage battery even if the charging time is extended.
- You are familiar with the notes on calibrating the high-voltage battery (→ page 166).

### Calibrating the high-voltage battery

The high-voltage battery can be calibrated in different ways:

- You confirm the display messages regarding calibration and follow the recommendations shown.
- You call up the **Battery Calibration** menu and start the normal or special calibration from there (→ page 150).
- You perform the special calibration of the high-voltage battery manually (→ page 168).  
Manual calibration is also possible when charging with direct current (DC).

The requirements for calibration are indicated by the following display messages:

- **To Ensure Max. Range, Perform Battery Calibration Start Charge Process to 100%**  
A normal calibration is required.
- **To Ensure Max. Range, Perform Battery Calibration Extra Charging Time: XX min Start AC Charging to 100%**  
A special calibration is required.
- **Battery Calibration Required AC Charging to 100% Start Possible at State of Charge: Max. XX% Outside Temp.: Min. XX °F**  
A special calibration is required.

- ▶ Perform a normal or special calibration as described below.

### Performing a normal calibration

- ⓘ Calibration will be carried out automatically during the next suitable charging process, once you have confirmed the calibration in the instrument cluster.  
A charging process is suitable if the following criteria are met:
  - You charge the vehicle up to a state of charge of 100%.
- ▶ Allow the vehicle to be charged until a state of charge of 100% has been reached.

### Performing a special calibration

- ⓘ Calibration will be carried out automatically during the next suitable charging process, once you have confirmed the calibration in the instrument cluster.  
A charging process is suitable if the following criteria are met:
  - The state of charge is a maximum of XX% at the beginning of the charging process, see display message in the instrument cluster.
  - You charge the vehicle using alternating current (AC) until a state of charge of 100% has been reached.
  - The outside temperature is at least 59°F (15°C).
  - No departure time is set before the end of the charging time.

- ⓘ During calibration, charging breaks may occur. Do not disconnect the charging cable from the vehicle. Otherwise the calibration may be interrupted.

- ⓘ During the calibration, the charging time may be extended once only.

- ⓘ Calibration can be interrupted if electrical consumers are connected or pre-entry climate control is activated.

- ▶ Confirm all display messages regarding calibration, provided the outside temperature and the state of charge conform to the required values shown in the display message. Calibration starts.
- ▶ Allow calibration to continue until the display message **Battery Calibration Successful Max. Battery Capacity and Range Restored** or **Battery Calibration Was Not Possible See Operator's Manual** appears.

### Battery Calibration Was Not Possible See Operator's Manual

- ▶ Check if a departure time has been preset that starts before the end of the charging time (incl. charging time extension) and deactivate it if possible (→ page 109).
- ▶ Check that the maximum state of charge is set to 100% (→ page 109).
- ▶ Check if an electrical consumer was used during calibration or the power supply was switched on.

- ▶ If possible, prevent the vehicle from cooling down too much or postpone calibration until the weather conditions are more favorable.
- ▶ Restart the calibration via the menu **Battery Calibration** on the instrument cluster (→ page 149).
- ▶ If the problems persist, perform a manual calibration of the high-voltage battery (→ page 168). Manual calibration is also possible when charging with direct current (DC).

### Manually calibrating the high-voltage battery

#### Requirements:

- The outside temperature must be at least 59 °F (15 °C)
- The state of charge must be less than 15%.
- You must be familiar with the notes on calibrating the high-voltage battery (→ page 166).

#### Manually calibrating the high-voltage battery

The high-voltage battery can be manually calibrated if the automatic calibration fails repeatedly or it is not possible to charge the battery using alternating current (AC).

- ▶ Park the vehicle in the immediate vicinity of a charging station that has a minimum output of 11 kW.
- ▶ The vehicle must remain parked for at least six hours.
- ⓘ The remaining range of the high-voltage battery must be sufficient to reach the nearest charging station.
- ⓘ Do not start or move the vehicle during the six hours in which it is non-operational. The doors must remain closed and neither the pre-entry climate control nor any electrical consumers can be active.
- ▶ Connect the vehicle to the charging station.
- ⓘ While the vehicle is charging, electrical consumers can be active and the power supply can be switched on.
- ▶ Charge the vehicle up to a state of charge of 100%.  
When a state of charge of 100% has been reached, the calibration is finished.

#### Further information on high-voltage calibration

- ⓘ The amount of time the vehicle remains connected to a public charging station is

increased if the high-voltage battery is calibrated during or after the charging process. Attention is drawn to extended charging times via display messages. If a public charging station is locked, additional fees may be incurred, depending on the operator's terms of use.

- ⓘ If the power supply is switched on or electrical consumers are used during calibration, the calibration may be aborted.
- ⓘ Setting a departure time may result in there being insufficient time for the planned calibration.  
If you require the state of charge to be as high as possible by the departure time, set a departure time (→ page 109).
- ⓘ Low outside temperatures can have a negative impact on the calibration. It is advisable to perform the calibration at temperatures above 59 °F (15 °C).
- ⓘ The need for calibration:
  - is dependent on use
  - is indicated by display messages in the instrument cluster (→ page 260).
  - can be verified via the on-board computer (→ page 150).
  - can be covered by performing a manual calibration (→ page 168).

#### Why is regular calibration necessary?

- ⓘ If the battery continues to be insufficiently calibrated, large deviations in the predicted range may result. There is a risk the vehicle's drive may experience a loss of output which either comes unexpectedly or for which a warning is issued too late. As a result, it may no longer be possible to continue the journey.

Batteries age over time and slowly lose some of their capacity, in other words, their ability to provide energy. This means that the 100% state of charge displayed in a vehicle that is one year old, for example, has a lower energy content than the 100% state of charge displayed in a new vehicle. During the calibration process, the exact energy content of the 100% state of charge is determined. The lower states of charge, the range and the charging time are calculated based on this determination.

Without calibration, the information displayed with respect to the range, the predicted range and the state of charge will become increasingly imprecise.

## Engine compartment

### Opening and closing the hood

- ⚠ DANGER** Risk of fatal injuries when carrying out maintenance work during the charging process

During the charging process, the high-voltage on-board electrical system is under high voltage.

- ▶ Do not perform any maintenance work during the charging process.

- ⚠ WARNING** Risk of accident due to driving with the hood unlocked

The hood may open and block your view.

- ▶ Never release the hood when driving.
- ▶ Before every trip, ensure that the hood is locked.

- ⚠ WARNING** Risk of injury due to overheated vehicle

If you open the hood in the event of an overheated vehicle or fire in the engine compartment, the following situations may occur:

- You may come into contact with hot gases.
  - You may come into contact with other escaping hot operating fluids.
- ▶ In the event of overheating or fire in the engine compartment, keep the hood closed and call the fire service.
  - ▶ Allow the overheated vehicle to cool down first if you need to open the hood.

- ⚠ WARNING** Risk of injury due to moving parts

Components in the engine compartment can continue to run or start unexpectedly even when the vehicle is switched off.

Observe the following before performing tasks in the engine compartment:

- ▶ Switch off the vehicle.
- ▶ Never touch the danger zone surrounding moving components, e.g. the rotation area of the fan.
- ▶ Remove jewelry and watches.
- ▶ Keep items of clothing and hair away from moving parts.

- ⚠ WARNING** Risk of burns from hot components in the engine compartment

Certain components in the engine compartment can be very hot, e.g. the drive system and the cooler.

- ▶ Allow the drive system to cool down and touch only the components described below.

If you have to carry out any work in the engine compartment, touch only the following components:

- Hood
- Washer fluid reservoir cap
- Coolant expansion reservoir cap

- ⚠ WARNING** Risk of injury from using the windshield wipers when the hood is open

If the windshield wipers start moving when the hood is open, you could be trapped by the wiper linkage.

- ▶ Always switch off the windshield wipers and vehicle before opening the hood.

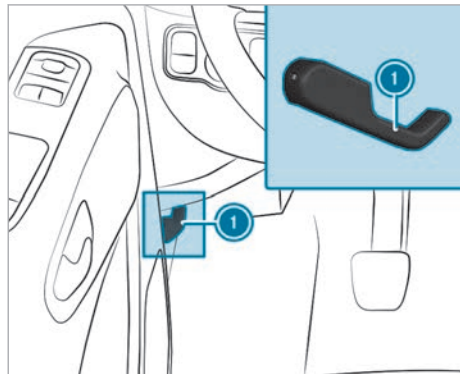

- ▶ Park the vehicle safely and on a surface that is as level as possible.
- ▶ Switch off the drive system.
- ▶ Secure the vehicle against rolling away.

- ⚠ WARNING** Risk of injury when the hood is opened

The hood may suddenly drop into the end position.

There is a risk of injury for anyone in the hood's range of movement.

- ▶ Before releasing the hood, ensure that the support is firmly seated in the holder.
- ▶ Open the hood only when there is no-one in its range of movement.

### Opening the hood

- ▶ Pull handle ① to release the hood.
- ▶ Reach into the gap and push the hood catch handle upwards.
- ▶ Open the hood and hold it up.

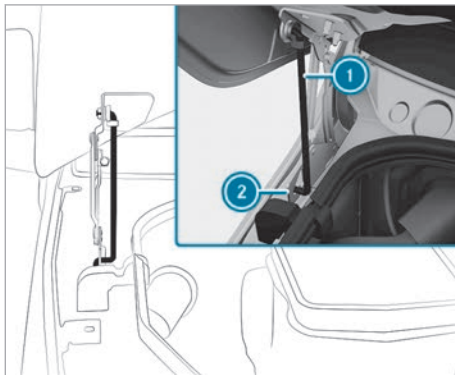

- ▶ Take support ① from the holder on the hood and pull it downwards.
- ▶ Insert the support into bracket ② below.

### Closing the hood

**⚠ WARNING** Risk of accident and injury when opening and closing the hood

The hood may suddenly drop into the end position.

There is a risk of injury for anyone in the hood's range of movement.

- ▶ Do not open or close the hood if there is a person in the hood's range of movement.

**! NOTE** Damage to the hood

Pushing the hood closed with your hands could damage it.

- ▶ To close the hood, let it drop from the specified height.

- ▶ Lift the hood slightly.

- ▶ Move support ① to the holder on the hood and apply light pressure to engage it.
- ▶ Lower the hood and let it drop from a height of approximately 0.5 ft (15 cm).
- ▶ If it is still possible to lift the hood a little, open the hood again and let it drop from a height of approximately 0.7 ft (20 cm) until it engages correctly.

### Checking the coolant level

If you have to carry out any work in the engine compartment, touch only the following components:

- Hood
- Washer fluid reservoir cap
- Coolant expansion reservoir cap

**⚠ WARNING** Risk of scalding from hot coolant

You may scald yourself if you open the cap when the drive system is at normal operating temperature.

- ▶ Allow the drive system to cool down before opening the cap.
- ▶ When opening the cap, wear protective gloves and safety glasses.
- ▶ Open the cap slowly to release pressure.

Allow the drive system and the cooling system to cool down before checking the coolant level or adding coolant.

The coolant temperature must be below 122°F (50°C).

**! NOTE** Paintwork damage due to coolant

If coolant gets on painted surfaces, the paintwork can be damaged.

- ▶ Add coolant carefully.
- ▶ Remove spilled coolant.

### Checking the coolant level

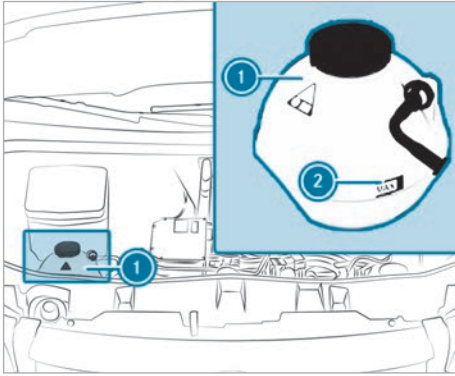

#### Coolant expansion reservoir (example)

- ▶ Park the vehicle on a level surface.
- ▶ Open the hood (→ page 169).
- ▶ Slowly turn coolant expansion reservoir cap ① half a turn counter-clockwise to release overpressure.
- ▶ Turn coolant expansion reservoir cap ① further and remove it.
- ▶ Check the coolant level.  
There is enough coolant in the coolant expansion reservoir if the coolant reaches upper MAX mark ②.

#### Adding coolant

- ▶ Refill the coolant to upper MAX mark ② on the coolant expansion reservoir.

Use only coolant approved by Mercedes-Benz to avoid damaging the engine cooling system.

- ▶ Replace coolant expansion reservoir cap ① and tighten it in a clockwise direction.
- ▶ Start the vehicle.
- ▶ After about five minutes, switch off the vehicle again and allow it to cool down.
- ▶ Check the coolant level again and add coolant if necessary.

① Observe additional coolant information (→ page 244).

### Filling the windshield washer system

**⚠ WARNING** Risk of fire and injury from windshield washer concentrate

Windshield washer concentrate is highly flammable.

- ▶ Avoid fire, open flames, smoking and the creation of sparks when using windshield washer concentrate.

**⚠ NOTE** Damage to the exterior lighting due to unsuitable windshield washer fluid

Unsuitable windshield washer fluid may damage the plastic surface of the exterior lighting.

- ▶ Only use windshield washer fluids that are also suitable for use on plastic surfaces, e.g. MB SummerFit or MB WinterFit.

#### Adding washer fluid

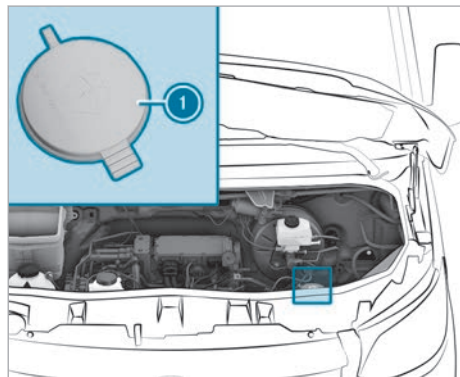

#### Washer fluid reservoir (example)

- ▶ Pre-mix the washer fluid in the correct mixing ratio in a container.
- ▶ Open the hood (→ page 169).
- ▶ Pull cap ① of the washer fluid reservoir upwards by the tab.
- ▶ Pour in the pre-mixed washer fluid.
- ▶ Push cap ① onto the filler opening until it audibly engages.
- ▶ Close the hood (→ page 169).

① Observe the further information about windshield washer fluid (→ page 245)

## Cleaning and care

### Notes on washing the vehicle in an automatic car wash

**⚠ WARNING** Risk of accident due to reduced braking effect after washing the vehicle

The braking effect is reduced after washing the vehicle.

- ▶ After the vehicle has been washed, brake carefully while paying attention to the traffic conditions until the braking effect has been fully restored.

**! NOTE** Risk of damage to the paintwork and plastic components

If you wash your vehicle in Touchless Automatic Car Wash systems that use special cleaning agents, the cleaning agents used can damage the paintwork or plastic components of the vehicle.

- ▶ Do not wash the vehicle in Touchless Automatic Car Wash systems that use special cleaning agents.

Make sure that the automatic car wash is suitable for the size of the vehicle.

Before washing the vehicle in an automatic car wash, fold in the outside mirrors and remove any additional antennas. Otherwise, the outside mirrors, antennas or the vehicle itself could be damaged.

Make sure any additional antennas are re-installed and that the outside mirrors are fully folded out again when you leave the automatic car wash.

To avoid damage to your vehicle, observe the following before using an automatic car wash:

- the side windows and the sliding window are completely closed.
- the blower for ventilation and heating is switched off.
- the windshield wiper switch is in position .

If the vehicle is very dirty, wash off excess dirt before cleaning the vehicle in an automatic car wash.

- ⓘ Removing the wax from the windshield and the wiper rubbers after washing the vehicle, will help avoid smearing and reduce wiper noise.

### Notes on using a power washer

**⚠ WARNING** Risk of an accident when using power washers with round-spray nozzles

The water jet can cause externally invisible damage.

Components damaged in this way may unexpectedly fail.

- ▶ Do not use a power washer with round-spray nozzles.
- ▶ Have damaged tires or chassis parts replaced immediately.

Never use a power washer in the vehicle interior. The amount of water accumulated by the pressure the power washer generates and the associated spray could cause considerable damage to the vehicle.

To avoid damage to your vehicle, observe the following when using a power washer:

- Maintain a distance of at least 11.8 in (30 cm) to the vehicle when using 25° flat-spray nozzles and concentrated-power jets and observe the information in the equipment manufacturer's operator's manual.
- Do not direct the nozzle of the power washer directly at sensitive parts such as tires, gaps, electrical components, batteries, lights and ventilation louvers.
- Maintain a minimum distance of 19.7 in (50 cm) from a reversing camera.

### Washing the vehicle by hand

Observe the legal requirements. For example, in a number of countries, washing by hand is permitted only in specially designated wash bays. In this case, make sure that a specially designated wash bay is used for washing by hand.

- ▶ Use a mild cleaning product, e.g. car shampoo.
- ▶ Wash the vehicle with lukewarm water and a soft car sponge. When doing so, do not expose the vehicle to direct sunlight.
- ▶ Carefully spray the vehicle with water and dry off with a chamois. Be careful not to point the water jet directly towards the air inlet grilles. Do not run the blower.
- ▶ Do not let the cleaning product dry on the paintwork.

At the onset of winter, remove all traces of road salt deposits carefully and as soon as possible.

**Notes on paintwork care**

**!** **NOTE** Paintwork damage and corrosion due to inadequate care

Failure to promptly and thoroughly remove dirt from bird droppings or other residue could result in paintwork damage and corrosion at a later date.

▶ Clean dirt off paint and matte finish thoroughly and as soon as possible.

Observe the notes on cleaning and care to avoid paintwork damage.

**Paint**

- Insect remnants: soak with insect remover and then wipe the treated areas clean.
- Bird droppings: soak with water and then wipe the treated areas clean.
- Tree resin, oils and greases: remove by rubbing gently with a cloth soaked in surgical spirit or lighter fluid.
- Coolant and brake fluid: remove with a damp cloth and clean water.
- Tar stains: use tar remover.
- Wax: use silicone remover.
- Do not attach stickers, films or similar materials.
- Remove any staining as soon as possible.

**Observe the following notes:**

|                    | Notes on cleaning and care   | Preventing damage to the vehicle  |
|--------------------|--|---|
| <b>Wheels/rims</b> | Use water and acid-free wheel cleaner.   | <ul style="list-style-type: none"> <li>• Do not use acidic alloy wheel cleaners to remove brake dust. Otherwise, wheel bolts and brake components could become damaged.</li> <li>• To avoid corrosion of brake discs and pads, drive for a few minutes after cleaning before parking the vehicle. The brake discs and pads will warm up and dry out.</li> </ul> |
| <b>Windows</b>     | Clean windows on the inside and outside with a damp cloth and with a cleaning agent recommended for Mercedes-Benz. | Do not use dry cloths or abrasive or solvent-based cleaning agents to clean the insides of windows.   |

**Matte finish**

- Use only care products approved for Mercedes-Benz.
- Do not polish the vehicle and light-alloy wheels.
- Use only car washes that comply with the latest engineering standards. If in doubt, always consult the car wash operator, in particular regarding whether the car wash is suitable for cleaning and care of matte paint finishes.
- Do not use a car wash program with a final hot wax treatment.
- Do not use paint cleaners, buffing or polishing products, gloss preservers, e.g. wax.
- Always have paintwork repairs carried out at a qualified specialist workshop.

**Notes on care of vehicle parts**

**⚠** **WARNING** Risk of entrapment if the windshield wipers are switched on while the windshield is being cleaned

If the windshield wipers are set in motion while you are cleaning the windshield or wiper blades, you can be trapped by the wiper arm.

▶ Always switch off the windshield wipers and the vehicle before cleaning the windshield or wiper blades.

|                          | Notes on cleaning and care  | Preventing damage to the vehicle                                       |
|--------------------------|---|--|
| <b>Wiper blades</b>      | With the wiper blades folded out, carefully clean them with a damp cloth.   | Do not clean the wiper blades too often.                               |
| <b>Exterior lighting</b> | Clean the lenses with a wet sponge and mild cleaning agent (e.g. car shampoo).  | Use only cleaning agents or cloths suitable for plastic lenses.        |
| <b>Sensors</b>           | Clean the sensors in the front and rear bumper and in the radiator grill with a soft cloth and car shampoo.   | When using a power washer, keep a minimum distance of 11.8 in (30 cm). |
| <b>Rear view camera</b>  | Use clean water and a soft cloth to clean the camera lens.  | Do not use a power washer.   |
| <b>Trailer hitch</b>     | <ul style="list-style-type: none"> <li>Remove traces of rust on the ball (e.g. with a wire brush).</li> <li>Remove dirt with a lint-free cloth.</li> <li>After cleaning, lightly oil or grease the ball head.</li> <li>Observe the notes on care in the trailer hitch manufacturer's operating instructions.</li> </ul> | Do not clean the ball neck with a power washer or solvent.             |
| <b>Sliding door</b>      | <ul style="list-style-type: none"> <li>Remove foreign objects from the vicinity of the contact plates and contact pins of the sliding door.</li> <li>Clean the contact plates and contact pins with a mild cleaning agent and a soft cloth.</li> </ul>  | Do not oil or grease the contact plates or the contact pins.           |

### Notes on cleaning and care of the interior

**⚠ WARNING** Risk of injury from plastic parts breaking off after the use of solvent-based care products

Care and cleaning products containing solvents can cause surfaces in the cockpit to become porous. When the airbags are deployed, plastic parts may break away.

▶ Do not use any care or cleaning products containing solvents to clean the cockpit.

**⚠ WARNING** Risk of injury or fatal injuries from bleached seat belts

Bleaching or dyeing seat belts can severely weaken them.

This can, for example, cause seat belts to tear or fail in an accident.

▶ Never bleach or dye seat belts.

**⚠ DANGER** Risk of fatal injuries due to electric shock

If you clean the 115 V socket with a wet cloth, you can get an electric shock.

There is a risk of fatal injury!

▶ Avoid the area around the 115 V socket when cleaning.

**! NOTE** Damage to property due to incorrect leather care

The steering wheel, seat covers and other parts of the vehicle interior can be made of leather.

Leather becomes brittle and can crack if it is incorrectly cared for or cleaned.

▶ If it gets dirty, thoroughly wipe it with a damp cloth (water or mild soapy water) or use leather care agents or cleaners that have been recommended and

approved by Mercedes-Benz. Then wipe it over again with a dry cloth.

- ▶ Do not use a microfiber cloth for cleaning.
- ▶ Do not soak the leather.
- ▶ Do not use cleaning agents containing solvents such as tar remover or wheel cleaner, polishes or waxes.

**!** **NOTE** Property damage due to disinfectants

The interior includes a number of sensitive surfaces such as displays, plastics and leather.

Disinfectants can contain alcohol and other substances that penetrate and damage surfaces. Technology behind buttons and displays can also be damaged.

- ▶ Do not use disinfectant on interior surfaces.

To prevent damage to the vehicle, observe the following notes for cleaning and care:

#### Seat belts

- Clean with lukewarm soapy water.
- Do not use chemical cleaning agents.
- Do not dry seat belts by heating them to over 176 °F (80 °C) or exposing them to direct sunlight.

#### Plastic trim

- Clean with a damp microfiber cloth.
- If very dirty: use a cleaning agent recommended for Mercedes-Benz.
- Do not attach stickers, films or similar materials.
- Do not allow to come into contact with cosmetics, insect repellent or sun creams.

#### Headliner

- Clean with a brush or dry shampoo.

#### Carpet

- Use a carpet and textile cleaning agent recommended for Mercedes-Benz.

#### Genuine leather seat covers

**!** **NOTE** Damage caused by wrong cleaners

- ▶ Do not use solvent-based cleaning agents such as tar remover or wheel cleaner; neither should you use polishes

or waxes. Otherwise you may damage the finish.

- Clean with a damp cloth and then wipe with a dry cloth.
- Leather care: use a leather care agent recommended for Mercedes-Benz.
- Do not allow the leather to become too damp.
- Do not use a microfiber cloth.

#### Imitation leather seat covers

- Vacuum up dirt such as crumbs or dust and then use a damp cotton cloth and a 1% soap solution to clean the entire seat cover.
- Use cleaning and care products recommended for Mercedes-Benz.
- Do not use a microfiber cloth.
- Do not use any oil-based cleaning and care products.
- Do not spot-clean.

#### Cloth seat covers

- Vacuum up dirt such as crumbs or dust and then use a damp microfiber cloth and a 1% soap solution to clean the entire seat cover.
- Use cleaning and care products recommended for Mercedes-Benz.
- Do not use any oil-based cleaning and care products.
- Do not spot-clean.

#### Steering wheel and gear or selector lever

- Clean with a damp cloth.

#### Steering wheel made from genuine leather

**!** **NOTE** Damage caused by wrong cleaners

- ▶ Do not use solvent-based cleaning agents such as tar remover or wheel cleaner; neither should you use polishes or waxes. Otherwise you may damage the finish.

- Clean with a damp cloth and a 1% soap solution and then wipe with a dry cloth.
- If very dirty: use a cleaning agent recommended for Mercedes-Benz.
- Leather care: use a leather care agent recommended for Mercedes-Benz.
- Do not allow the leather to become too damp.
- Do not use a microfiber cloth.

- i** Leather is a natural product. It exhibits natural surface properties, such as differences in structure, marks caused by growth and injury or subtle color differences.

**Pedals and floor mats**

- Clean with a damp cloth.
- Do not use any cleaning and care products.

**Real wood and trim elements**

- Clean with a microfiber cloth.
- Black piano-lacquer look: clean with a damp cloth and soapy water.
- If very dirty: use a cleaning agent recommended for Mercedes-Benz.
- Do not use any cleaning agents, polishes or waxes containing solvents.

**Vehicle interior**

- Clean with a damp cloth.
- Do not use a power washer.
- Allow the vehicle interior to dry completely after cleaning.
- Do not allow liquids to penetrate into gaps or cavities.

**Curtains**

- The curtains may be dry-cleaned only.
- Do not wash the curtains.

## Emergency

### Removing the safety vest

▶ Remove the safety vest from the storage compartment in the driver's door.

- ⓘ Safety vests can also be stored in the storage compartments of the rear doors and the co-driver door.

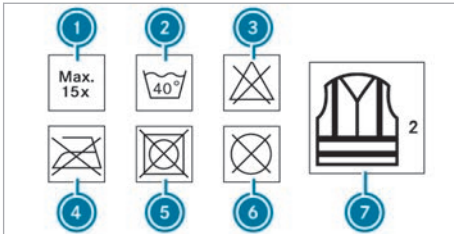

- ① Maximum number of washes
- ② Maximum wash temperature
- ③ Do not bleach
- ④ Do not iron
- ⑤ Do not tumble dry
- ⑥ Do not dry-clean
- ⑦ This is a class 2 vest

The safety vest only fulfills the legally required standards if it is the correct size and is completely closed.

Replace the safety vest if:

- Damaged or if the reflex strips are dirty
- The maximum permitted number of washes is exceeded
- The safety vest's fluorescence has faded

### Removing the first-aid kit (soft sided)

The first-aid kit (soft sided) is located in the storage compartment in the front passenger door.

▶ Remove the first-aid kit (soft sided) from the storage compartment.

### Removing the warning lamp

The warning lamp is located in the stowage compartment in the front-passenger door.

▶ Remove the warning lamp from the stowage compartment.

## Emergency hammer

**⚠ WARNING** Risk of injury if the emergency hammer is used

If you smash the windows with the emergency hammer, you may injure yourself:

- Due to glass splinters flying around
- On glass splinters lying around
- On pieces of glass that remain in the window seal

▶ It is essential to protect skin and eyes, e.g. with an item of clothing.

▶ Be particularly careful when leaving the vehicle through a smashed window.

## Emergency Call System

### Information on the emergency call system

**USA only:** Your vehicle is equipped with the Emergency Call System ("eCall"). This feature can help save lives in the event of an accident. eCall in no way replaces assistance provided from dialing 911.

The emergency call system ("eCall") is generally available for your vehicle for 10 years ex works.

eCall only functions in areas where mobile phone coverage is available from the wireless service providers. Insufficient network coverage from the wireless service providers may result in an emergency call not being transmitted.

eCall is a standard feature in your Mercedes-Benz vehicle. In order to function as intended, the system relies on the transmission of data detailed in the Transmitted Data section that follows (→ page 179). To disable eCall, a customer must visit an authorized Mercedes-Benz Service department to deactivate the vehicle's communication module.

**Deactivating this module prevents the activation of all Digital Extras. After the deactivation of eCall, automatic emergency call and manual emergency call will not be available.**

The vehicle must be switched on before an automatic emergency call can be made.

ⓘ eCall is activated at the factory.

- i** eCall can be deactivated by an authorized Mercedes-Benz dealer. Please note that in the event ownership of the vehicle is transferred to another owner in its deactivated state, eCall will remain deactivated unless the new owner visits an authorized Mercedes-Benz dealership to reactivate the system.

### Overview of the emergency call system

eCall can help to reduce the time between an accident and the arrival of emergency services at the site of the accident. It helps locate an accident site in places that are difficult to access. However, even if a vehicle is equipped with eCall, this does not mean the system is ON. As such, eCall does not replace dialing 911 in the event of an accident.

An emergency call can be made automatically (→ page 178) or manually (→ page 178). Only make emergency calls if you or others are in need of rescue. Do not make an emergency call in the event of a breakdown or a similar situation.

If there is a malfunction of the emergency call system, the speakers, microphone, air bag or the SOS button, for example, are faulty.

You can recognize a malfunction in the emergency call system by the following displays:

- The red SOS NOT READY message appears in the display of the instrument cluster or in the media display.
- The SOS button lights up red continuously.

### Triggering an automatic emergency call

#### Requirements:

- The vehicle is switched on.
- The 12 V on-board electrical system battery is sufficiently charged.

If restraint systems such as air bags or Emergency Tensioning Devices have been activated after an accident, eCall may automatically initiate an emergency call.

When the emergency call is made:

- A voice connection is made to the Mercedes-Benz emergency call center.
- A message with accident data is transmitted to the Mercedes-Benz emergency call center.

The Mercedes-Benz emergency call center can transmit the vehicle position data to one of the emergency call centers.

The SOS button in the overhead control panel flashes until the emergency call is finished.

It is not possible to immediately end an automatic emergency call.

If no connection can be made to the emergency services either, a corresponding message appears in the media display.

- ▶ Dial the local emergency number on your mobile phone.

If an emergency call has been initiated:

- Remain in the vehicle if the road and traffic conditions permit you to do so until a voice connection is established with the emergency call center operator.
- Based on the call, the operator decides whether it is necessary to call rescue teams and/or the police to the accident site.
- If no vehicle occupant answers, an ambulance is sent to the vehicle immediately.

### Triggering a manual emergency call

- ▶ **Via the SOS button in the overhead control panel:** press the SOS button for at least one second.

When the emergency call is made:

- A voice connection is made to the Mercedes-Benz emergency call center.
  - A message with accident data is transmitted to the Mercedes-Benz emergency call center.
- The Mercedes-Benz emergency call center can transmit the vehicle position data to one of the emergency call centers.
- Remain in the vehicle if the road and traffic conditions permit you to do so until a voice connection is established with the emergency call center operator.
  - Based on the call, the operator decides whether it is necessary to call rescue teams and/or the police to the accident site.

If no connection can be made to the public emergency services, a corresponding message appears in the display.

- ▶ Dial the local emergency number on your mobile phone.

### Transmitted data with the emergency call

Data transmitted by the eCall includes but is not limited to:

- Vehicle's GPS position data
- GPS position data on the route (a few () hundred meters before the incident)
- Direction of travel
- Vehicle identification number
- Vehicle drive type
- Estimated number of people in the vehicle
- Whether the emergency call was initiated manually or automatically
- Time of the accident

Data transmitted is vehicle information. For any questions about the collection, use and sharing of the eCall system data, please contact MBUSA's Customer Assistance Center at 800-FOR-MERC.

For Canada, please contact MBC's Customer Assistance Center at 1-800-387-0100.

Customer requests for covered information should be submitted via the same channels.

For accident clarification purposes, the following measures can be taken up to an hour after the emergency call has been initiated:

- The current vehicle position can be determined
- A voice connection to the vehicle occupants can be established

### Function of the emergency call system self-diagnosis

Your car verifies the operability of the emergency call system each time the ignition is ON.

In the event of a system malfunction, you will be informed by the following signals:

- The **SOS NOT READY** message in the instrument cluster display or the red **SOS NOT READY** message on the media display, if available
- The flashing indicator lamp in the overhead control panel

Please, make sure, that during 30 seconds after switching ignition ON the red indicator **SOS NOT READY** in the upper right corner of the multimedia display is switched OFF, this means the emergency call system passed diagnostics successfully.

### Flat tire

#### Notes on flat tires

**⚠ WARNING** Risk of accident due to a flat tire

A flat tire strongly impairs the vehicle's driving characteristics, as well as its steering and braking characteristics.

- ▶ Do not drive with a flat tire.
- ▶ Replace the flat tire with the spare wheel. Alternatively, consult a qualified specialist workshop.

In the event of a flat tire, the following options are available depending on your vehicle's equipment:

- You can make a breakdown assistance call using the me button for a service and information call in the overhead control panel (→ page 151).
- Change the wheel (→ page 204).

### Battery

#### Notes on the 12 V on-board electrical system battery

**⚠ WARNING** Risk of an accident due to work carried out incorrectly on the battery

Work carried out incorrectly on the battery can, for example, lead to a short circuit. This can restrict functions relevant for safety systems and impair the operating safety of your vehicle.

You could lose control of the vehicle in the following situations in particular:

- When braking
- In the event of abrupt steering maneuvers and/or when the vehicle's speed is not adapted to the road conditions
- ▶ In the event of a short circuit or a similar incident, contact a qualified specialist workshop immediately.
- ▶ Do not drive on.
- ▶ Always have work on the battery carried out at a qualified specialist workshop.

- ⓘ Further information on ABS (→ page 120)  
Further information on ESP® (→ page 121)

For safety reasons, Mercedes-Benz recommends that you use only batteries that have been tested and approved for your vehicle by Mercedes-Benz. These batteries provide increased impact protection to prevent vehicle occupants from suffering acid burns should the battery be damaged in an accident.

**⚠ WARNING** Risk of explosion due to electrostatic charge

Electrostatic charge can ignite the highly explosive gas mixture in the battery.

- ▶ To discharge any electrostatic charge that may have built up, touch the metal vehicle body before handling the battery.

The highly flammable gas mixture is created while the battery is charging and when jump-starting.

**⚠ WARNING** Danger of chemical burns from the battery acid

Battery acid is caustic.

- ▶ Avoid contact with the skin, eyes or clothing.
- ▶ Do not lean over the battery.
- ▶ Do not inhale battery gases.
- ▶ Keep children away from the battery.
- ▶ Immediately rinse battery acid off thoroughly with plenty of clean water and seek medical attention immediately.

**♻ ENVIRONMENTAL NOTE** Environmental damage due to improper disposal of batteries



Batteries contain pollutants. It is illegal to dispose of them with the household rubbish.



Dispose of batteries in an environmentally responsible manner. Take discharged batteries to a qualified specialist workshop or to a collection point for used batteries.

Observe the safety notes and protective measures when handling batteries.



Risk of explosion



Fire, naked flames and smoking are prohibited when handling the battery. Avoid creating sparks.



Electrolyte or battery acid is corrosive. Avoid contact with the skin, eyes and clothing. Wear suitable protective clothing, in particular gloves, an apron and a safety mask. Immediately rinse electrolyte acid splashes off with clean water. If necessary, seek medical advice.



Wear eye protection.



Keep children at a safe distance.



Observe this Operator's Manual.

Consult a qualified specialist workshop if you wish to leave your vehicle parked up for long periods.

### Notes on the high-voltage battery

**⚠ DANGER** Risk of fire and explosion from excessive internal pressure of the high-voltage battery

In the event of a vehicle fire, flammable gas can escape and ignite.

- ▶ If there is an unusual smell, smoke or burn marks, stop the charging process immediately.
- ▶ Leave the danger zone immediately. Secure the danger area at a sufficient distance.
- ▶ Call the fire service.

In order for the high-voltage battery to achieve the maximum possible service life, it should always be sufficiently charged. Have the battery's state of charge checked if you park the vehicle for a longer period of time. Exhaustive discharging caused by the vehicle standing idle for lengthy periods can

damage the high-voltage battery. If the vehicle is idle for lengthy periods, run it for a few minutes once every four weeks to maintain the high-voltage battery.



Risk of explosion



Fire, open flames and smoking are prohibited when handling the battery. Avoid creating sparks.



Electrolyte or battery acid is corrosive. Avoid contact with the skin, eyes and clothing. Wear suitable protective clothing, in particular gloves, an apron and a safety mask. Immediately rinse electrolyte acid splashes off with clean water. Consult a doctor if necessary.



Wear eye protection.



Keep children at a safe distance.



Observe this Operator's Manual.

Further information on charging the high-voltage battery (→ page 107).

### Starting assistance and charging the 12 V on-board electrical system battery

- ▶ Have starting assistance provided only by a qualified specialist workshop, e.g. an authorized Mercedes-Benz Center.
- ▶ Have the 12 V on-board electrical system battery charged only at a qualified specialist workshop, e.g. an authorized Mercedes-Benz Center.

### Replacing the 12 V on-board electrical system battery

- ▶ Only have the 12 V on-board electrical system battery replaced at a qualified specialist workshop, e.g. an authorized Mercedes-Benz Center.

### 12-V-auxiliary battery under the front passenger seat or in the engine compartment

- ▶ Only have work on the 12 V auxiliary battery carried out at a qualified specialist workshop, e.g. in a authorized Mercedes-Benz Center.

### Towing or tow-starting

#### Permitted towing methods

In the event of a breakdown, Mercedes-Benz recommends that you have the vehicle transported instead of towed.

Use a tow rope or a tow bar when towing with both axles on the ground; other towing methods are not permissible.

If you notice that the vehicle has lost coolant, towing it away is not permitted. Have the vehicle transported.

**⚠ WARNING** Risk of accident due to limited safety-related functions during the towing process

Safety-related functions are limited or no longer available in the following situations:

- The vehicle is switched off.
- The brake system or power steering system is malfunctioning.
- The energy supply or the on-board electrical system is malfunctioning.

When your vehicle is towed away, significantly more effort may be required to steer and brake than is normally required.

- ▶ Use a tow bar.
- ▶ Make sure that the steering wheel can move freely before towing the vehicle away.

**! NOTE** Damage to the vehicle due to towing away incorrectly

- ▶ Observe the instructions and notes on towing away.

**! NOTE** Damage due to automatic braking

When Active Brake Assist or the HOLD function is activated, the vehicle brakes automatically in certain situations.

To avoid damage to the vehicle, deactivate these systems in the following or similar situations:

- ▶ When towing
- ▶ In a car wash

**I** **NOTE** Damage to drive system due to incorrect maneuvering

If the vehicle is moved rearwards when the drive system has failed, e. g. when pushing

or maneuvering, the drive system can be damaged.

- ▶ Move the vehicle rearwards only briefly and slowly.

### Permitted towing methods



#### Both axles on the ground

Yes, a maximum of 30 miles (50 km) at 30 mph (50 km/h)



#### Rear axle raised

Yes, if the steering wheel is fixed in the center position with a steering wheel lock

- ① If the transmission cannot be shifted into position **N**, transport the vehicle (→ page 183). A towing vehicle with lifting equipment is required for vehicle transport.
- ① If there is damage to the engine cooling system, the vehicle may only be moved with the drive axle raised.

If the 12 V on-board electrical system battery is discharged, please note the following points:

- The drive system cannot be started.
- It is not possible to release or apply the electric parking brake.
- It is not possible to shift the transmission to position **N** or **P**.

### Towing the vehicle with both axles on the ground

**I** **NOTE** Damage due to towing away at excessively high speeds or over long distances

The drivetrain could be damaged when towing at excessively high speeds or over long distances.

- ▶ A towing speed of 30 mph (50 km/h) must not be exceeded.
- ▶ A towing distance of 30 miles (50 km) must not be exceeded.

- ▶ Observe the notes on permissible towing methods (→ page 181).
- ▶ Make sure that the battery is connected and charged.

① Towing is not permitted in the following cases:

- If the drive system is not switched on.
- If there is no driver in the vehicle being towed.
- If the transmission cannot be shifted to position **N**.
- If the instrument cluster display is not working.
- If the display message  **Towing Not Permitted See Operator's Manual** is shown or another display message that indicates a problem.

Transporting the vehicle (→ page 183).  
A tow truck with lifting equipment is required to transport the vehicle.

**⚠ WARNING** Risk of accident when towing a vehicle which is too heavy

If the vehicle to be tow-started or towed away is heavier than the permissible gross mass of your vehicle, the following situations can occur:

- The towing eye may become detached.
- The vehicle/trailer combination may swerve or rollover.

▶ Before tow-starting or towing away, check if the vehicle to be tow-started or towed away exceeds the permissible gross mass.

- ▶ Information on the vehicle's gross mass vehicle rating can be found on the vehicle identification plate (→ page 241).
- ▶ Do not open the driver's door or the front passenger door. Otherwise the transmission automatically shifts to position **P**.
- ▶ Install the towing eye (→ page 184).
- ▶ Secure the towing device.

**! NOTE** Damage due to incorrect connection of the tow bar

▶ Only connect the tow rope or tow bar to the towing eyes.

- ▶ Deactivate automatic locking (→ page 43).
- ▶ Do not activate the HOLD function.
- ▶ Deactivate the tow-away alarm (→ page 55).
- ▶ Deactivate Active Brake Assist (→ page 125).
- ▶ Shift the transmission to position **N** (→ page 106).
- ▶ (→ page 118)Release the parking brake.

**! NOTE** Damage due to excessive tractive power

If you pull away sharply, the tractive power may be too high and the vehicles could be damaged.

▶ Pull away slowly and smoothly.

### Towing the vehicle with the rear axle raised

**⚠ WARNING** Risk of accident when towing with the vehicle switched on

When towing with the rear axle raised and the vehicle switched on, ESP® may apply the brakes on the front axle in an uncontrolled manner.

The vehicle may skid.

▶ Switch the vehicle off before towing with the rear axle raised.

**! NOTE** Damage if the vehicle is switched on

If you leave the vehicle switched on while towing it with the rear axle raised, intervention by ESP® may damage the brake system.

▶ Switch off the vehicle.

- ▶ Observe the notes on permissible towing methods (→ page 181).
- ▶ Switch on the hazard warning light system (→ page 73).
- ▶ Move the front wheels to the straight-ahead position.
- ▶ Release the parking brake (→ page 118).
- ▶ Switch off the vehicle.

### Loading the vehicle for transport

- ▶ Observe the notes on permissible towing methods (→ page 181).
- ▶ Connect the tow bar to the towing eye to load the vehicle.
- ▶ Load the vehicle onto the transporter.
- ▶ Use the parking brake to secure the vehicle against rolling away.
- ▶ Only secure the vehicle by the wheels.

### Towing eye storage location

The towing eye is located in the vehicle tool kit in the front passenger footwell (→ page 186).

## Installing/removing the towing eye

### Installing the front towing eye

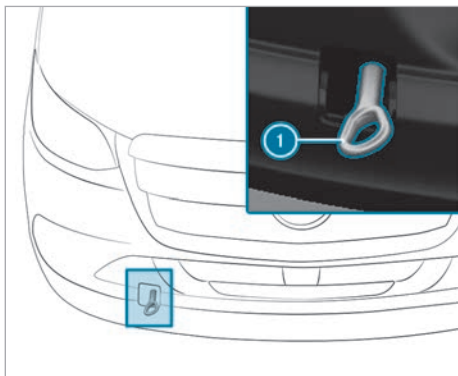

- ▶ Press the top of the cover and remove the cover.
- ▶ Screw in the towing eye ① clockwise as far as it will go and tighten.

### Removing the front towing eye

- ▶ Unscrew the towing eye ① counter-clockwise.
- ▶ Insert the cover with the tabs at the top and push in at the bottom until the cover engages.

### Rear towing eye

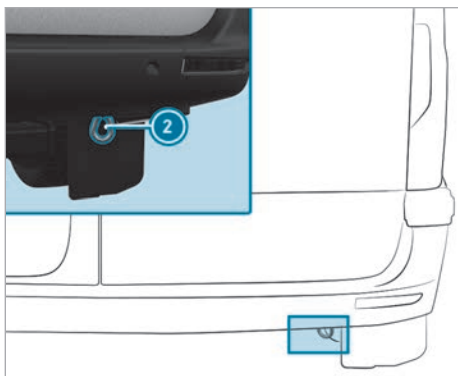

### Rear towing eye

- ① The rear towing eye ② is permanently attached to the vehicle.

**!** **NOTE** Damage to the vehicle due to incorrect use of the towing eye or trailer hitch

When a towing eye or trailer hitch is used to recover a vehicle, the vehicle may be damaged in the process.

- ▶ Only use the towing eye or trailer hitch to tow away or tow start the vehicle.
- ▶ Do not use the towing eye or trailer hitch to tow the vehicle during recovery.

## Tow-starting the vehicle

- ▶ If the drive system does not start, have the vehicle transported to the nearest qualified specialist workshop, e.g. an authorized Mercedes-Benz Center.
- ▶ The drive system cannot be started by tow-starting. Do not attempt to tow-start the vehicle.

## Electrical fuses

### Notes on electrical fuses

**!** **WARNING** Risk of accident and injury due to overloaded lines

If you manipulate or bridge a faulty fuse or if you replace it with a fuse with a higher amperage, the electric line could be overloaded.

This could result in a fire.

- ▶ Always replace faulty fuses with specified new fuses containing the correct amperage.

**!** **NOTE** Damage due to incorrect fuses

Electrical components or systems could be damaged by incorrect fuses.

- ▶ Only use fuses which have been approved by Mercedes-Benz and which have the correct fuse rating.

The electrical fuses in your vehicle isolate defective circuits. If a fuse blows, all the components on the circuit and their functions will cease to operate.

Blown fuses must be replaced with fuses of an equivalent specification, which you can determine by the color and fuse rating. The fuse allocation chart and further information on the electric fuses

and relays can be found in the "Fuse allocation chart" supplement.

**!** **NOTE** Damage or malfunctions caused by moisture

Moisture may cause damage to the electrical system or cause it to malfunction.

- ▶ When the fuse box is open, make sure that no moisture can enter the fuse box.
- ▶ When closing the fuse box, make sure that the seal of the lid is positioned correctly on the fuse box.

If the new fuse which has been inserted also blows, have the cause traced and rectified at a qualified specialist workshop.

Make sure of the following before replacing a fuse:

- The vehicle is secured such that it does not roll away.
- All electrical consumers are switched off.
- The vehicle is switched off.

The fuses are located in various fuse boxes:

- Fuse box in the co-driver footwell (→ page 185)
- Fuse box in the seat base of the driver's seat (→ page 185)

### Opening the fuse box in the seat base of the driver's seat

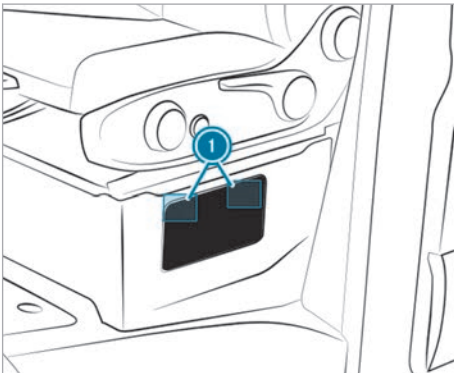

- ▶ **To open:** press down and unclip fasteners ❶ on the cover.
- ▶ Remove the cover.
- ▶ **To close:** press the cover firmly into the seat base until fasteners ❶ clip in.

### Opening and closing the fuse box in the front passenger's footwell

#### Opening the fuse box

The fuse box is under the vehicle toolkit in the stowage compartment of the front passenger's footwell.

- ▶ Unlocking and removing the stowage compartment cover in the front passenger's footwell (→ page 186).



Example: vehicle tool kit insert

- ▶ Lift the insert at marked positions ❶.
- ▶ Pull the insert out of clips ❷.

#### Closing the fuse box

- ▶ Slide the insert into clips ❷.
- ▶ Close the insert by pressing on marked positions ❶.
- ▶ Position the stowage compartment cover in the front passenger's footwell and lock it (→ page 186).

### Vehicle tool kit

#### Information on the vehicle tool kit

The vehicle tool kit is located in the stowage compartment in the footwell on the front passenger side (→ page 186).

The vehicle tool kit contains:

- a towing eye
- a screwdriver with Torx®, Phillips and slotted heads

The vehicle tool kit may also contain the following, for example:

- an open-end wrench
- a wheel wrench
- a release tool for the parking lock
- an insert bit
- a socket wrench

### Unlocking and removing the stowage compartment cover

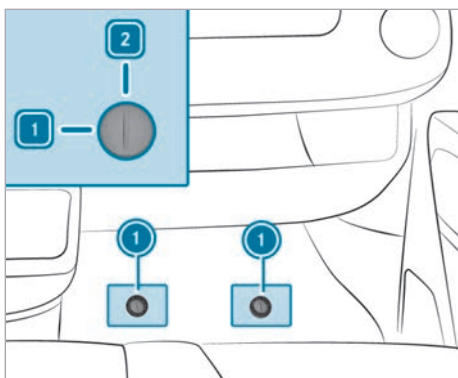

▶ Remove the rubber mat from the co-driver's footwell.

▶ **To unlock:** turn quick-release fastener ① counter-clockwise to position 1.

▶ Slightly raise and pull out the cover.

### Inserting and locking the cover

▶ Slide in the cover and press it downwards.

▶ Press down quick-release fastener ① until it engages.

▶ **To lock:** turn quick-release fastener ① clockwise to position 2.

### Removing the vehicle tool kit

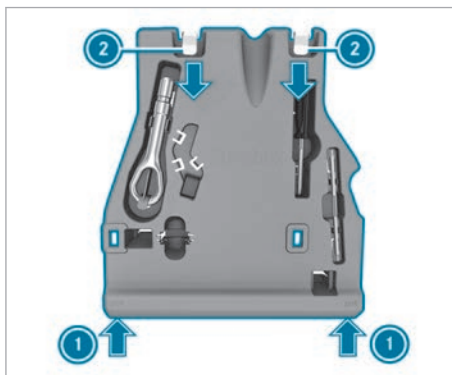

Example: vehicle tool kit insert

- ▶ Lift the insert at marked positions ①.
- ▶ Pull the insert out of clips ②.

### Storing the vehicle tool kit

- ▶ Slide the insert into clips ②.
- ▶ Close the insert by pressing on marked positions ①.

### Hydraulic jack

#### Information on the hydraulic jack

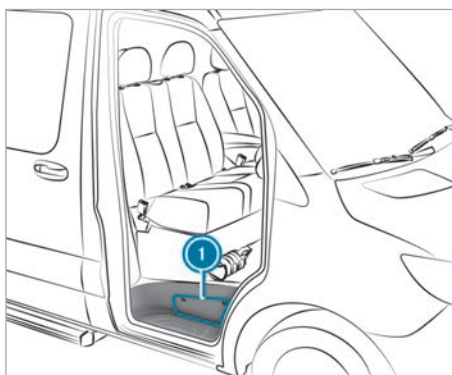

The hydraulic jack is located in side compartment ① above the co-driver door step.

The jack has a maximum weight of 16.5 lbs (7.5 kg) depending on the vehicle's equipment. You will find the maximum load capacity of the jack stated on the adhesive label attached to the jack. If there is a malfunction, please contact a qualified specialist workshop.

Jack maintenance:

- Clean and grease all moving parts after use.
- Extend and retract the pistons fully every six months.

### Removing the pump lever rod and the jack

**Requirements:**

- The co-driver door is open.

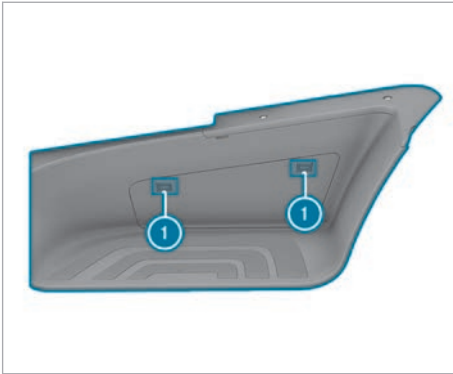

- ▶ **To open:** press down and unclip fasteners ① on the cover.
- ▶ Remove the cover.
- ▶ Pull out the holder completely and place it on the step.



- ▶ Remove jack ② and the pump lever rod.
- ▶ **To close:** press the cover firmly so that fasteners ① engage.

### Information on noise or unusual driving characteristics

While driving, pay attention to vibrations, noises and unusual driving characteristics, e.g. pulling to one side. This may indicate damage to the wheels or tires. If you suspect that a tire is defective, reduce your speed. Stop the vehicle as soon as possible to check if wheels and tires have been damaged or are no longer functioning properly. Hidden tire damage could also be causing the unusual driving characteristics. If no signs of damage can be detected, have the tires and wheels checked at a qualified specialist workshop.

### Notes on regularly inspecting wheels and tires

#### **⚠ WARNING** Risk of injury through damaged tires

Damaged tires can cause tire pressure loss.

- ▶ Check the tires regularly for signs of damage and replace any damaged tires immediately.

Check the wheels and tires of your vehicle for damage regularly, i.e. at least every two weeks, as well as after driving off-road or on rough roads. Damaged wheels can lead to a loss of tire pressure.

Look out for the following types of damage, for example:

- cuts in the tires
- punctures in the tires
- tears in the tires
- bulges on tires
- deformation or severe corrosion on wheels

#### **⚠ WARNING** Risk of hydroplaning due to insufficient tire tread

Insufficient tire tread will result in reduced tire grip.

- ▶ Thus, you should regularly check the tread depth and the condition of the tread across the entire width of all tires.

Minimum tread depth for:

- Summer tires:  $\frac{1}{8}$  in (3 mm)
- M+S tires:  $\frac{1}{6}$  in (4 mm)

- ▶ For safety reasons, replace the tires before the legally prescribed limit for the minimum tread depth is reached.

Conduct the following checks regularly on all wheels, at least once a month or as required, e.g. before a long journey or when driving off-road:

- Check the tire pressure (→ page 190)
- Check the valve caps

The valves must be protected against moisture and dirt by the valve caps approved especially for your vehicle by Mercedes-Benz.

- Visually inspect the tread depth and the tire tread across the whole tire width

The minimum tire tread depth for summer use is  $\frac{1}{8}$  in (3 mm) and for winter use  $\frac{1}{6}$  in (4 mm).

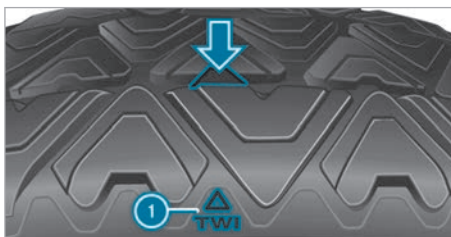

Markings ① show in which places the bar indicators (arrow) are integrated into the tire tread. They are visible as soon as the tread depth is approximately  $\frac{1}{16}$  in (1.6 mm).

### Information on driving with summer tires

At temperatures below 50 °F (10 °C) summer tires significantly lose elasticity and thus traction and stopping power. Change the tires on your vehicle to M+S tires. Using summer tires at very cold temperatures could cause cracks to form, thereby damaging the tires permanently. Mercedes-Benz cannot accept responsibility for this type of damage.

Always observe the maximum permissible speed specified for the mounted summer tires (→ page 199).

After you mount the summer tires:

- restart the tire pressure monitoring system (→ page 194)
- check the tire pressure (→ page 190)

### Information on M+S tires

**⚠ WARNING** Risk of an accident due to insufficient tire tread

M+S tires with a tread depth of less than  $\frac{1}{8}$  in (4 mm) are not suitable for use in winter and do not provide sufficient grip.

▶ M+S tires with a tread depth of less than  $\frac{1}{8}$  in (4 mm) must be replaced immediately.

At temperatures below 50 °F (10 °C) use winter tires or all-season tires marked M+S.

Only winter tires bearing the  snowflake symbol in addition to the M+S marking provide the best possible grip in wintry road conditions.

Only these tires allow driving safety systems, e.g. ABS and ESP® to function optimally also in winter. These tires have been developed specifically for driving in snow.

Use M+S tires of the same make and tread on all wheels to maintain safe handling characteristics.

Observe the maximum permissible speed specified for the M+S tires you have installed (→ page 199).

If you install M+S tires that have a lower maximum permissible speed than the maximum design speed of the vehicle, affix an appropriate information label in the driver's field of vision. You can obtain this at a qualified specialist workshop.

Once you have installed the M+S tires, take the following measures:

- Restart the tire pressure monitoring system (→ page 194)
- Check the tire pressure (→ page 193)

### Notes on snow chains

**⚠ WARNING** Risk of accident due to incorrectly installed snow chains

If you have installed snow chains on the front wheels, they may drag against the vehicle body or chassis components.

- ▶ Never install snow chains on the front wheels.
- ▶ Only install snow chains on the rear wheels in pairs.

**⚠ WARNING** Risk of accident due to unsuitable snow chains

Commercially available snow chains can come loose and damage chassis components or brake hoses.

- ▶ Only install snow chains that have been approved by Mercedes-Benz for these tires.

For safety reasons, Mercedes-Benz recommends that you only use snow chains that have been tested and approved. You can obtain information about snow chains from any qualified specialist workshop.

**⚠ WARNING** Risk of accident due to snow chains breaking

If you drive too fast with snow chains, they can break, injure other persons, and damage the vehicle.

- ▶ Observe the maximum permissible speed for operation with snow chains.

**! NOTE** Damage to the wheel trim from mounted snow chains

If snow chains are mounted to steel wheels, the wheel trims can be damaged.

- ▶ Remove the wheel trims of steel wheels before mounting snow chains.

Observe the following notes when using snow chains:

- Snow chains are only permissible for certain wheel/tire combinations. You can obtain information on this matter at a qualified specialist workshop.
- For safety reasons, only use snow chains that have been specifically approved for your vehicle by Mercedes-Benz, or snow chains with the same quality standard.
- The snow chains must be retightened after driving approximately 0.6 miles (1 km). This is the only way to ensure the snow chains are optimally installed with clearance to adjacent components.
- Use snow chains only when the road surface is completely snow-covered. Remove the snow chains as soon as possible when you come to a road that is not snow-covered.

- Local regulations may restrict the use of snow chains. Observe the applicable regulations before installing snow chains.
  - If snow chains are installed, the maximum permissible speed is 30 mph (50 km/h).
- i** You can deactivate ESP® to start off (→ page 122). This allows the wheels to spin, achieving an increased propulsive force.

### Tire pressure

#### Notes on tire pressure

**⚠ WARNING** Risk of an accident due to tire pressure that is too low or too high

Tires with pressure that is too high or too low pose the following dangers:

- The tires can burst.
  - The tires can wear excessively and/or unevenly.
  - The driving characteristics as well as the steering- and braking may be greatly impaired.
- ▶ Observe the recommended tire pressure and check the tire pressure of all tires including the spare wheel:
- monthly
  - when the load changes
  - before leaving on a longer journey
  - when the operating conditions change, e.g. off-road driving
  - when driving at over 155 mph (250 km/h)
- ▶ Adjust the tire pressure if necessary.

Driving with tire pressure that is too high or too low can:

- shorten the service life of the tires
- contribute to tire damage
- adversely affect driving characteristics and thus driving safety, e.g. due to hydroplaning

**⚠ WARNING** Risk of accident due to too low a tire pressure

Tires with pressure that is too low can overheat and burst as a consequence.

In addition, they also suffer from irregular wear, which can significantly impair the braking properties and the handling characteristics.

▶ Avoid excessively low tire pressure.

Tire pressure that is too low can result in:

- tire defects as a result of overheating
- impaired handling characteristics
- uneven wear
- increased fuel consumption

**⚠ WARNING** Risk of accident due to too high a tire pressure

Tires with excessively high pressure can burst. In addition, they also suffer from irregular wear, which can significantly impair the braking properties and the handling characteristics.

▶ Avoid excessively high tire pressures.

Tire pressure that is too high can result in:

- increased braking distance
- impaired handling characteristics
- uneven wear
- impaired driving comfort
- susceptibility to damage

**⚠ WARNING** Risk of accident due to repeated pressure drop in the tires

The wheels, valves or tires could be damaged. Too low a tire pressure can lead to the tires bursting.

- ▶ Examine the tires for foreign objects.
- ▶ Check whether the tire has a puncture or the valve has a leak.
- ▶ If you are unable to rectify the damage, contact a qualified specialist workshop.

You can find information on recommended tire pressure for the vehicle's factory-installed tires on the following labels:

- tire and loading information and tire pressure table on the B-pillar of your vehicle (→ page 195).

Please also note the maximum tire pressure (→ page 199).

Use a suitable pressure gage to check the tire pressure. The outward appearance of a tire does not allow any reliable conclusion about the tire pressure.

**ENVIRONMENTAL NOTE** Environmental damage due to insufficient or excessive tire pressure

Overinflating or underinflating your tires will shorten their service life.

▶ Check the tire pressure regularly, but at least every 14 days.

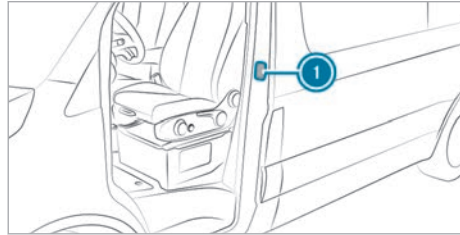

① Tire pressure table B-pillar

② The data in the illustrations are shown as examples.

**Vehicles with a tire pressure monitoring system:** you can also check the tire pressure via the instrument cluster.

Only check tire pressure when the tires are cold. Conditions for cold tires:

- The vehicle has been parked with the tires out of direct sunlight for at least three hours.
- The vehicle has traveled less than 1 mile (1.6 km).

A rise in the tire temperature of 18°F (10°C) increases the tire pressure by approx. 10 kPa (0.1 bar/1.5 psi). Take this into account when checking the tire pressure of warm tires.

The tire pressure recommended for increased load/speed in the tire pressure table may affect the ride comfort.

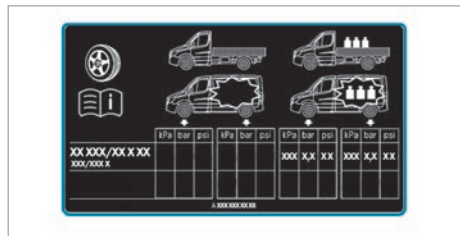

**WARNING** Risk of accident due to unsuitable accessories on tire valves

If you mount unsuitable accessories onto tire valves, the tire valves may be overloaded and malfunction, which can cause tire pressure loss.

▶ Only screw standard valve caps or valve caps specifically approved by Mercedes-Benz for your vehicle onto the tire valve.

The tire pressure table shows the recommended tire pressure for the tires installed on this vehicle at the factory. The recommended tire pressure are valid for cold tires and different vehicle load conditions.

If one or more tire sizes precede a tire pressure, the tire pressure information following is only valid for those tire sizes.

If the preceding tire sizes are supplemented by the  symbol, the tire pressure information following shows alternative tire pressures.

The load conditions "partially laden" and "fully laden" are defined in the table by varying weights.

Some tire pressure tables only show the rim diameter instead of the complete tire size, e.g. **R16**. The rim diameter is part of the tire size and can be found on the side wall of the tire (→ page 199).

**Notes on trailer operation**

The applicable tire pressure for the tires of the rear axle is always the recommended tire pressure for a full load.

**Overview of the tire pressure table**

The tire pressure table can be found on the B-pillar on the driver's side.

**Front axle tire pressures on vehicles with rear-wheel drive and single tires****Max. front axle load 4101 lbs (1860 kg)**

| Tire/disk wheel       | Load condition | Max. front axle load<br>4101 lbs (1860 kg) |
|-----------------------|----------------|--|
| LT245/75 R16 120/116Q | Fully laden    | 320 kPa (3.2 bar/46 psi)                   |

**Front axle tire pressures on vehicles with rear-wheel drive and single tires****Max. front axle load 4409 lbs (2000 kg)**

| Tire/disk wheel       | Load condition | Max. front axle load<br>4409 lbs (2000 kg) |
|-----------------------|----------------|--|
| LT245/75 R16 120/116Q | Fully laden    | 360 kPa (3.6 bar/52 psi) <sup>1)</sup>     |

<sup>1)</sup> Only valid for vehicles with long wheelbase 171 in (4350 mm) and a permissible gross mass of over 7716 lbs (3.5 t).

**Rear axle tire pressures on vehicles with rear-wheel drive and single tires****Max. rear axle load 5357 lbs (2430 kg)**

| Tire/disk wheel       | Load condition                | Max. rear axle load<br>5357 lbs (2430 kg) |
|-----------------------|-------------------------------|---|
| LT245/75 R16 120/116Q | Fully laden                   | 480 kPa (4.8 bar/70 psi)                  |
| LT245/75 R16 120/116Q | Partially laden <sup>2)</sup> | 440 kPa (4.4 bar/64 psi) <sup>2)</sup>    |

<sup>2)</sup> The use of this reduced tire pressures is only permissible if it can be ensured by weighing the vehicle that the rear axle load of 4960 lbs (2250 kg) is not exceeded. In case of doubt, inflate to 480 kPa (4.8 bar/70 psi).

Be sure to also observe the following further related subjects:

- Notes on tire pressure (→ page 190)
- Tire and Loading Information placard (→ page 195)
- Maximum tire pressure (→ page 199)

**Tire pressure monitoring system****Function of the tire pressure monitoring system**

**⚠ DANGER** Risk of accident due to incorrect tire pressure

Each tire, including the spare (if provided), should be checked monthly when cold and inflated to the inflation pressure recommended

by the vehicle manufacturer on the vehicle placard or tire inflation pressure label. (If your vehicle has tires of a different size than the size indicated on the vehicle placard or tire inflation pressure label, you should determine the proper tire inflation pressure for those tires.)

As an added safety feature, your vehicle has been equipped with a tire pressure monitoring system (TPMS) that illuminates a low tire pressure telltale when one or more of your tires is significantly under-inflated. Accordingly, when the low tire pressure telltale illuminates, you should stop and check your tires as soon as possible, and inflate them to the proper pressure. Driving on a significantly under-inflated tire causes the tire to overheat and can lead to tire failure. Under-inflation also reduces fuel efficiency and tire tread life, and may affect the vehicle's handling and stopping ability. Please note that the TPMS is not a substitute for proper tire maintenance, and it is the driver's

responsibility to maintain correct tire pressure, even if under-inflation has not reached the level to trigger illumination of the TPMS low tire pressure telltale.

Your vehicle has also been equipped with a TPMS malfunction indicator to indicate when the system is not operating properly. The TPMS malfunction indicator is combined with the low tire pressure telltale. When the system detects a malfunction, the telltale will flash for approximately one minute and then remain continuously illuminated. This sequence will continue upon subsequent vehicle start-ups as long as the malfunction exists.

When the malfunction indicator is illuminated, the system may not be able to detect or signal low tire pressure as intended. TPMS malfunctions may occur for a variety of reasons, including the installation of replacement or alternate tires or wheels on the vehicle that prevent the TPMS from functioning properly.



The system measures the tire pressure and the temperature of the tires installed on the vehicle by means of a tire pressure sensor.

New tire pressure sensor, e.g. in winter tires, are automatically taught-in during the first journey.

The tire pressure and the tire temperature appear in the display of the instrument cluster (→ page 146).

If there is a substantial loss of tire pressure, a warning is issued:

- via display messages (→ page 268)
- via the  warning lamp in the instrument cluster (→ page 280)

It is the driver's responsibility to set the tire pressure to the recommended cold tire pressure suitable for the operating situation. Set the tire pressure for cold tires using a tire pressure gauge. Note that the tire pressure monitoring system must first learn the correct tire pressure for the current operating situation.

In most cases, the tire pressure monitoring system will automatically update the new reference values after you have changed the tire pressure. You can, however, also update the reference values by restarting the tire pressure monitoring system manually (→ page 194).

### System limits

The system may be impaired or may be inoperative in the following situations:

- if the tire pressure has been set incorrectly
- if there is a sudden pressure loss caused, for example, by a foreign object penetrating the tire
- if there is a malfunction caused by another radio signal source
- if there is a change of tire size

Bear in mind the following related topic:

- Notes on tire pressure (→ page 190)

### Checking the tire pressure with the tire pressure monitor

#### Requirements:

- The vehicle is switched on.

Instrument cluster:

 Service  Tires

One of the following displays appears:

- The current tire pressure and tire temperature of the individual wheels.

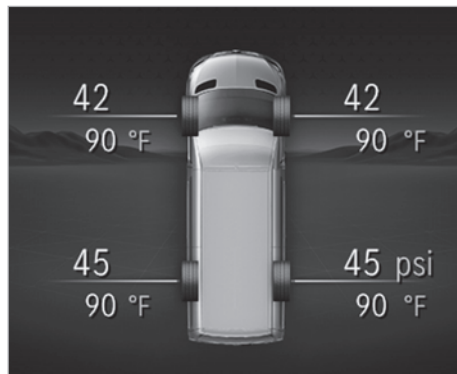

Instrument cluster display

- **Tire pressure will be displayed after driving a few minutes:** The teach-in process of the system is not yet complete. The tire pressures are already being monitored.

 Compare the tire pressure with the recommended tire pressure for the current operating status (→ page 191). Observe the notes on tire temperature (→ page 190).

- i** The values displayed on the instrument cluster may deviate from those of the tire pressure gauge because they refer to sea level. At high altitudes, the tire pressure values indicated by a pressure gauge are higher than those shown in the instrument cluster. If that is the case, do not reduce the tire pressure.

Bear in mind the following related topic:

- Notes on tire pressure (→ page 190)

### Restarting the tire pressure monitoring system

#### Requirements:

- The recommended tire pressure is correctly set for the respective operating condition on each of the wheels (→ page 190).
- **Restart the tire pressure monitoring system in the following situations:**
  - If the tire pressure has changed.
  - If the wheels or tires have been changed or newly installed.

Instrument cluster:

↳ [Service](#) ▶▶ [Tires](#)

- ▶ Scroll down in the menu. The message [Use current pressures as new reference values?](#) appears in the instrument cluster.
- ▶ Confirm the message to initiate a restart. The message [Tire Press. Monitor Restarted](#) appears in the instrument cluster. Current warning messages are deleted and the  yellow warning lamp goes out. After you have driven for a few minutes, the system checks whether the current tire pressure is within the specified range. The current tire pressure is then accepted as a reference value and monitored.

Bear in mind the following related topic:

- Notes on tire pressure (→ page 190)

### Radio equipment approval of the tire pressure monitoring system

| Country | Radio equipment approval number   |
|---------|---|
| Canada  | IC: 4008C-TSSRE4A<br>Operation is subject to the following two conditions:<br>(1) this device may not cause harmful interference, and<br>(2) this device must accept any interference received, including interference that may cause undesired operation.  |
| Mexico  | Model: TSSRE4A & TSSSG4G6, IFETEL: RLVHUTS17-0806   |
| USA     | FCC ID: YGOTSSRE4A<br>This device complies with Part 15 of the FCC Rules. Operation is subject to the following two conditions: (1) this device may not cause harmful interference, and (2) this device must accept any interference received, including interference that may cause undesired operation.<br>WARNING: Any changes or modification not expressly approved by the party responsible for compliance could void the user's authority to operate this equipment. |

## Loading the vehicle

### Tire and Loading Information placard

**⚠ WARNING** Risk of an accident when driving with an overloaded tire

Overloaded tires may overheat and burst. Overloaded tires can impair the steering and handling characteristics and lead to brake failure.

- ▶ Observe the load rating of the tires.
- ▶ The load rating must be at least half the permissible axle load of the vehicle.
- ▶ Mercedes-Benz recommends you use the load-bearing index, which is given in the vehicle documents.
- ▶ Never overload the tires by exceeding the maximum load.

Only vehicles with a gross vehicle weight of less than 10,000 lbs (4,536 kg) have a Tire and Loading Information placard on the B-pillar on the driver's side.

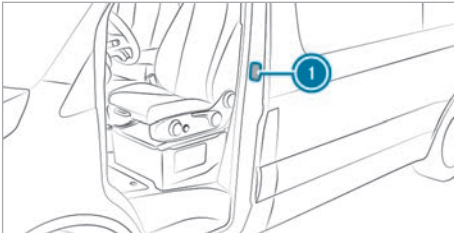

① Tire and Loading Information placard

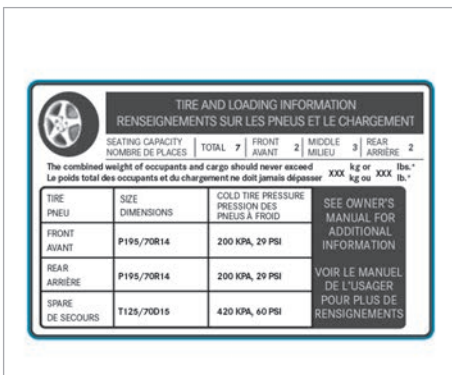

① The data shown in the illustration are sample data.

The Tire and Loading Information placard shows:

- The maximum number of seats indicates the maximum number of occupants permitted to travel in the vehicle.
- The maximum permissible load equals the gross weight of all vehicle occupants, the luggage and any payload.
- The recommended tire pressure for cold tires. The recommended tire pressures apply to the maximum permissible load and up to the maximum permissible vehicle speed.

Also observe the following information:

- The information about permissible weights on the vehicle identification plate (→ page 241)
- The information about tire pressures in the tire pressure table (→ page 191)

Additional related subjects:

- Determining the maximum payload (→ page 195)
- Notes on tire pressure (→ page 190)

### Steps to determine the correct maximum load

The following steps have been developed based on the mandatory requirements for all manufacturers under Title 49, Code of U.S. Federal Regulations, Part 575 in accordance with the "National Traffic and Motor Vehicle Safety Act of 1966".

- ▶ **Step 1:** Locate the statement, "The combined weight of occupants and cargo should never exceed XXX kg or XXX lbs." ("Das kombinierte Gewicht von Insassen und Ladung sollte niemals XXX kg bzw. XXX lbs übersteigen") on the Tire and Loading Information placard of your vehicle.
- ▶ **Step 2:** Determine the combined weight of the driver and passengers who will be traveling in your vehicle.
- ▶ **Step 3:** Subtract the combined weight of the driver and passengers from XXX kg or XXX lbs.
- ▶ **Step 4:** The resulting figure equals the permissible load capacity for cargo and luggage. For example, if the "XXX" amount equals 1400 lbs and there will be five 150 lb passengers in your vehicle, the amount of available cargo and luggage load capacity is 650 lbs (1400 - 750 (5 x 150) = 650 lbs).
- ▶ **Step 5:** Determine the combined weight of any cargo and luggage being loaded into the vehicle. For safety reasons, this weight must not

exceed the permissible load capacity calculated in step 4.

▶ **Step 6:** If your vehicle is towing a trailer, load from the trailer is transferred to your vehicle. Consult these instructions in order to determine how this reduces the potential load and luggage capacity of your vehicle.

ⓘ Note that not all vehicles are approved for trailer operation. Trailer operation is only permissible if a trailer hitch is installed and a towing capacity is specified in your vehicle documents. If in doubt, ask an authorized Mercedes-Benz dealer.

Even if you have calculated the total payload carefully, you should still make sure that the maximum permissible gross mass and the maximum permissible axle loads of your vehicle are not exceeded. Information for this can be found on the vehicle identification plate.

▶ Weigh the laden vehicle – including driver, passengers and payload – on a suitable vehicle weighbridge. The measured values must not exceed the maximum permitted values listed on the vehicle identification plate.

Additional related subjects:

- Sample calculation for determining the maximum payload (→ page 196)
- Tire and Loading Information placard (→ page 195)
- Tire pressure table (→ page 191)
- Vehicle identification plate (→ page 241)

**Sample calculation for determining the maximum load**

The following table has examples of how to calculate total and cargo load capacities with varying seating configurations and different numbers and sizes of occupants. The following examples use a maximum load of 1,500 lbs (680 kg). **This value is for illustrative purposes only.** Make sure you are using the actual load limit for your vehicle stated on your vehicle's Tire and Loading Information placard (→ page 195).

The higher the weight of all the occupants, the smaller the maximum load for luggage.

**Step 1**

|  | Example 1         | Example 2         |
|--|-------------------|-------------------|
| Combined maximum weight of occupants and load (data from the Tire and Loading Information placard) | 1500 lbs (680 kg) | 1500 lbs (680 kg) |

**Step 2**

|  | Example 1   | Example 2                   |
|--|---|-----------------------------|
| Number of people in the vehicle (driver and occupants) | 5   | 1                           |
| Distribution of the occupants                          | Front: 2<br>Rear: 3   | Front: 1                    |
| Weight of occupants                                    | Occupant 1: 150 lbs (68 kg)<br>Occupant 2: 180 lbs (82 kg)<br>Occupant 3: 160 lbs (73 kg)<br>Occupant 4: 140 lbs (63 kg)<br>Occupant 5: 120 lbs (54 kg) | Occupant 1: 200 lbs (91 kg) |
| Total weight of all occupants                          | 750 lbs (340 kg)  | 200 lbs (91 kg)             |

Step 3

|  | Example 1   | Example 2   |
|--|---|---|
| Permissible load (maximum gross vehicle weight rating from the Tire and Loading Information placard minus the gross weight of all occupants) | 1500 lbs (680 kg) - 750 lbs (340 kg) = 750 lbs (340 kg) | 1500 lbs (680 kg) - 200 lbs (91 kg) = 1300 lbs (589 kg) |

Tire labeling

Overview of tire labeling

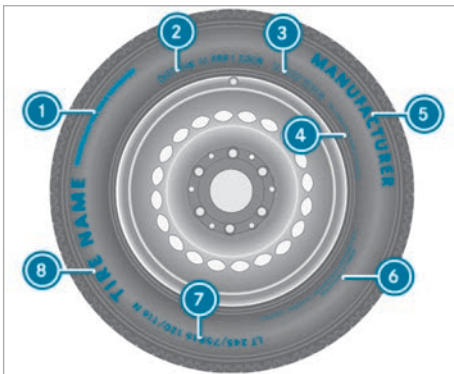

- ① Uniform Tire Quality Grading Standards (→ page 197)
- ② DOT (Department of Transportation), (TIN) Tire Identification Number (→ page 198)
- ③ Maximum tire load (→ page 198)
- ④ Maximum tire pressure (→ page 199)
- ⑤ Manufacturer
- ⑥ Characteristics of the tire (→ page 199)
- ⑦ Tire size designation, load-bearing capacity and speed rating (→ page 199)
- ⑧ Tire name
- ⓘ The data shown in the illustration is sample data.

Information on tire quality grades

According to the requirements of the U.S. Department of Transportation's "Uniform Tire Quality Grading Standards" tire manufacturers must grade their tires using the following three performance factors:

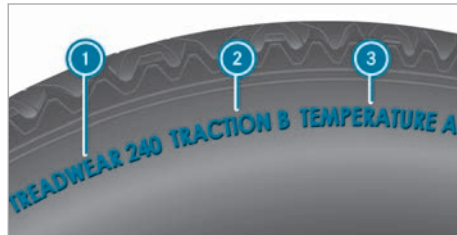

- ① Tread wear grade
- ② Traction grade
- ③ Temperature grade
- ⓘ The data shown in the illustration is sample data.
- ⓘ This grading is not legally prescribed for Canada, but specified in most cases anyway.

Tread wear grade

The tread wear grade is a comparative grading based on tread wear grade tests conducted under controlled conditions on a specified U.S. Department of Transportation test track. For example, a tire graded 150 would wear one and one-half times as well on the government test track as a tire graded 100.

The relative performance of tires depends upon the actual conditions of their use, however, and may depart significantly from the norm due to variations in driving habits, service practices and differences in road characteristics and climate conditions.

Traction grade

**⚠ DANGER** Risk of accident due to inadequate traction

The traction grade assigned to this tire is based on straight-ahead braking traction tests.

- ▶ Always adapt your driving style and drive at a speed to suit the prevailing traffic and weather conditions.

**I NOTE** Damage to the drivetrain from wheelspin

▶ Avoid wheelspin.

The traction grades – from highest to lowest – are AA, A, B and C. These grades relate to the tire's ability to come to a standstill on a wet pavement under controlled conditions on a specified U.S. government test surface made from asphalt and concrete.

### Temperature grade

**A WARNING** Risk of accident from tire overheating and tire failure

Excessive speed, underinflation, or excessive loading, either separately or in combination, can cause excessive heat build-up and possible tire failure.

- ▶ Observe the recommended tire pressure.
- ▶ Regularly check the pressure of all the tires.
- ▶ Adjust the tire pressure, if necessary.

The temperature grades are A (highest grade), B and C. These relate to a tire's resistance to heat and its ability to release heat on a specified test wheel in laboratory tests under controlled conditions. Sustained high temperatures can cause the material of the tire to degenerate and reduce tire life. In addition, excessively high temperatures can lead to sudden tire failure. Grade C refers to a performance which all passenger vehicle tires must exhibit, according to the U.S. Department of Transportation's requirements.

### Information on DOT and TIN (Tire Identification Number)

U.S. tire regulations indicate that every tire manufacturer or retreader must imprint a TIN in or on the sidewall of each tire produced.

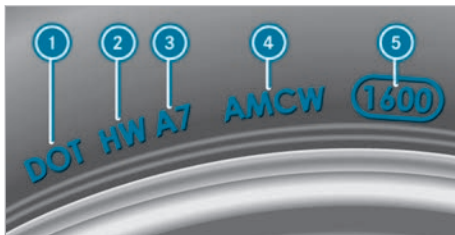

**i** The data shown in the illustration is sample data.

The TIN is a unique identification number for tires and consists of the following components:

- **DOT (Department of Transportation):** tire symbol **1** indicates that the tire complies with the requirements of the U.S. Department of Transportation.
- **Manufacturer identification code:** manufacturer identification code **2** provides information about the tire manufacturer. New tires have a code with two symbols. Retreaded tires have a code with four symbols. For further information about retreaded tires, see (→ page 202).
- **Tire size:** identifier **3** describes the tire size.
- **Tire type code:** tire type code **4** can be used by the manufacturer as a code to describe specific characteristics of the tire.
- **Date of manufacture:** date of manufacture **5** provides information about the age of a tire. The 1st and 2nd numbers indicate the calendar week and the 3rd and 4th numbers indicate the year of manufacture (e.g. "3208" refers to the 32nd week of the year 2008).

### Information on maximum tire load

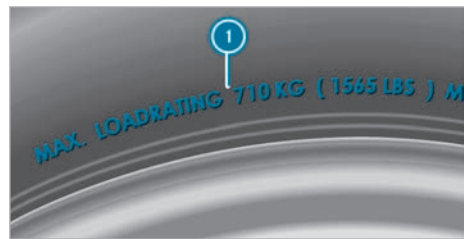

**i** The data shown in the illustration is sample data.

Maximum tire load **1** is the maximum permissible weight for which the tire is approved.

Do not overload the tires by exceeding the maximum permissible load. The maximum permissible load can be found on the vehicle's Tire and Loading Information placard on the B-pillar on the driver's side (→ page 195).

### Information on maximum tire pressure



**i** The data shown in the illustration is sample data.

Maximum permitted tire pressure **1** for which the tire is approved must not be exceeded.

### Information on tire characteristics

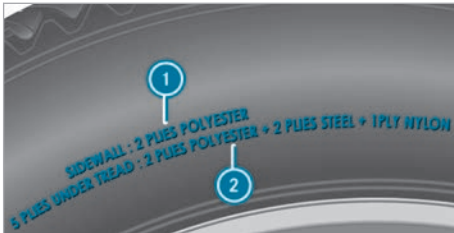

**i** The data shown in the illustration is sample data.

This information describes the type of tire cord and the number of layers in sidewall **1** and under tire tread **2**.

### Tire size designation, load-bearing capacity and speed rating

**⚠ WARNING** Risk of injury through exceeding the specified tire load-bearing capacity or the permissible speed rating

Exceeding the specified tire load rating or the permissible speed rating may lead to tire damage and to the tires bursting.

- ▶ Therefore, only use tire types and sizes approved for your vehicle model.
- ▶ Observe the tire load rating and speed rating required for your vehicle.

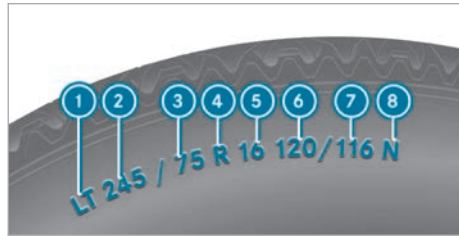

- 1** First letter(s)
- 2** Nominal tire width in millimeters
- 3** Aspect ratio in %
- 4** Tire code
- 5** Rim diameter
- 6** Load-bearing index, Single tires
- 7** Load-bearing index, twin tires
- 8** Speed rating

**i** The data shown in the illustration is sample data.

Further information about reading tire data can be obtained from any qualified specialist workshop.

#### First letter(s) **1**:

- "LT": light truck tires according to US manufacturing standards
- "C": tires for commercial usage in accordance with European manufacturer standards

#### Aspect ratio (in percent) **3**:

The size ratio between the tire height and tire width and is shown in percent (tire height divided by tire width).

#### Tire code **4** (tire type):

- "R": radial tire

#### Rim diameter **5**:

The diameter of the bead seat (not the diameter of the rim flange). The rim diameter is specified in inches (in).

#### Load-bearing index **6** and **7**:

Numerical code which specifies the maximum load-bearing capacity of a tire ("91" equals, e.g. 1,356 lb (615 kg)).

The tire load-bearing capacity must be at least half the permissible axle load of the vehicle. Do not overload the tires by exceeding the maximum permissible load of the tires.

See also:

- Maximum permissible load on the Tire and Loading Information placard (→ page 195)
- Maximum tire load (→ page 198)

### Speed rating

Specifies the approved maximum design speed of the tire.

-  An electronic speed limiter prevents your vehicle from exceeding a speed of 130 mph (210 km/h).

Ensure that your tires have the required speed rating. You can obtain information on the required speed rating at an authorized Mercedes-Benz Center.

### Summer tires

| Index | Speed rating                |
|-------|-----------------------------|
| L     | Up to 75 mph<br>(120 km/h)  |
| M     | Up to 81 mph<br>(130 km/h)  |
| N     | Up to 87 mph<br>(140 km/h)  |
| P     | Up to 93 mph<br>(150 km/h)  |
| Q     | Up to 100 mph<br>(160 km/h) |
| R     | Up to 106 mph<br>(170 km/h) |

### Summer, all-season and winter tires

| Index              | Speed rating               |
|--------------------|----------------------------|
| L M+S <sup>1</sup> | Up to 75 mph<br>(120 km/h) |
| M M+S <sup>1</sup> | Up to 81 mph<br>(130 km/h) |
| N M+S <sup>1</sup> | Up to 87 mph<br>(140 km/h) |
| P M+S <sup>1</sup> | Up to 93 mph<br>(150 km/h) |

| Index              | Speed rating                |
|--------------------|-----------------------------|
| Q M+S <sup>1</sup> | Up to 100 mph<br>(160 km/h) |
| R M+S <sup>1</sup> | Up to 118 mph<br>(170 km/h) |

<sup>1</sup>: Or "M+S  " for winter tires.

Winter tires are marked with the  snowflake symbol and fulfill the requirements of the Rubber Manufacturers Association (RMA) and the Rubber Association of Canada (RAC) regarding the tire traction on snow.

### Information on definitions (tires and loading)

**Tire structure and characteristics:** describes the number of layers or the number of rubber-coated layers in the tire tread and the tire wall. These are made of steel, nylon, polyester and other materials.

**Bar:** metric unit for tire pressure. 14.5038 pounds per square inch (psi) and 100 kilopascals (kPa) are the equivalent of 1 bar.

**DOT (Department of Transportation):** DOT marked tires fulfill the requirements of the U.S. Department of Transportation.

**Average weight of vehicle occupants:** the number of occupants for which the vehicle is designed multiplied by 150 lbs (68 kg).

**Uniform Tire Quality Grading Standards:** a uniform standard to grade the quality of tires with regards to tread quality, tire traction and temperature characteristics. The quality grading assessment is made by the manufacturer in accordance with test specifications of the U.S. government. The quality grade of a tire is imprinted on the sidewall of the tire.

**Recommended tire pressure:** the recommended tire pressure is the pressure specified for the tires installed on the vehicle at the factory.

The Tire and Loading Information placard contains the recommended tire pressures for cold tires, the maximum permissible load and the maximum permissible vehicle speed.

The tire pressure table contains the recommended tire pressures for cold tires under various operating conditions, i.e. load and/or speed of the vehicle.

**Increased vehicle weight due to optional equipment:** the combined weight of all standard and

optional equipment available for the vehicle, regardless of whether it is actually installed on the vehicle or not.

**Rim:** the part of the wheel on which the tire is installed.

**GAWR (Gross Axle Weight Rating):** GAWR is the gross axle weight rating. The actual load on an axle must never exceed the Gross Axle Weight Rating. You can find the Gross Axle Weight Rating on the B-pillar on the driver's side.

**Speed rating:** the speed rating is part of the tire identification. It specifies the speed range for which a tire is approved.

**GVW (Gross Vehicle Weight):** the Gross Vehicle Weight includes the weight of the vehicle including fuel, tools, the spare wheel, accessories installed, occupants, luggage and the trailer drawbar noseweight if applicable. The Gross Vehicle Weight must never exceed the Gross Vehicle Weight Rating (GVWR) specified on the B-pillar on the driver's side.

**GVWR (Gross Vehicle Weight Rating):** the GVWR is the maximum permitted gross weight of the fully laden vehicle (weight of the vehicle including all accessories, occupants, fuel, luggage and the trailer drawbar noseweight if applicable). The Gross Vehicle Weight Rating is specified on the vehicle identification plate on the B-pillar on the driver's side.

**Maximum weight of the laden vehicle:** the maximum weight is the sum of the vehicle's curb weight, weight of the accessories, maximum load and the weight of the factory-installed optional equipment.

**Kilopascal (kPa):** metric unit for tire pressure. 6.9 kPa are the equivalent of 1 psi. Another unit for tire pressure is bar. 100 kilopascals (kPa) are the equivalent of 1 bar.

**Curb weight:** the weight of a vehicle with standard equipment including the maximum capacity of fuel, oil and coolant. It also includes the air-conditioning system and optional equipment if these are installed on the vehicle, but does not include passengers or luggage.

**Maximum tire load:** the maximum tire load is the maximum permissible weight in kilograms or lbs for which a tire is approved.

**Maximum permissible tire pressure:** maximum permissible tire pressure for one tire.

**Maximum load on one tire:** maximum load on one tire. This is calculated by dividing the maximum axle load for one axle by two.

**PSI (pounds per square inch):** standard unit of measurement for tire pressure.

**Aspect ratio:** relationship between tire height and tire width in percent.

**Tire pressure:** pressure inside the tire applying outward force to every square inch of the tire's surface. The tire pressure is specified in pounds per square inch (psi), in kilopascals (kPa) or in bar. The tire pressure should only be corrected when the tires are cold.

**Tire pressure of cold tires:** the tires are cold when the vehicle has been parked with the tires out of direct sunlight for at least three hours and the vehicle has been driven less than 1 mile (1.6 km).

**Tire contact surface:** the part of the tire that comes into contact with the road.

**Tire bead:** the purpose of the tire bead is to ensure that the tire sits securely on the wheel rim. There are several wire cores in the tire bead to prevent the tire from changing length on the wheel rim.

**Side wall:** the part of the tire between the tread and the tire bead.

**Special equipment weight:** the combined weight of those optional extras that weigh more than the replaced standard parts and more than 5 lbs (2.3 kg). Special equipment, such as high-performance brakes, level control system, a roof luggage rack or a high-performance battery, are not included in the curb weight and the weight of the accessories.

**TIN (Tire Identification Number):** a unique identification number which can be used by a tire manufacturer to identify tires, for example, in a product recall, and thus identify the purchasers. The TIN is made up of the manufacturer identification code, tire size, tire type code and the manufacturing date.

**Load-bearing index:** the load-bearing index (also load index) is a code that contains the maximum load-bearing capacity of a tire.

**Traction:** traction is the result of friction between the tires and the road surface.

**Wear indicator:** narrow bars (tread wear bars) that are distributed over the tire tread. If the tire tread is level with the bars, the wear limit of 1/16 in (1.6 mm) has been reached.

**Distribution of vehicle occupants:** distribution of vehicle occupants over designated seat positions in a vehicle.

**Maximum permissible payload weight:** nominal load and luggage load plus 150 lbs (68 kg) multiplied by the number of seats in the vehicle.

### Changing a wheel

#### Notes on selecting, installing and replacing tires

You can obtain information regarding permissible wheel/tire combinations at a qualified specialist workshop.

**▲ WARNING** Risk of accident due to incorrect wheel and tire dimensions

If wheels and tires of the wrong size are used, the service brakes or wheel suspension components may be damaged.

- ▶ Always replace wheels and tires with ones that fulfill the specifications of the original part.

For wheels, pay attention to the following:

- Designation
- Type
- Permissible wheel load
- Wheel offset

For tires, pay attention to the following:

- Designation
- Manufacturer
- Type
- Load-bearing index
- Speed rating

**▲ WARNING** Risk of injury through exceeding the specified tire load-bearing capacity or the permissible speed rating

Exceeding the specified tire load rating or the permissible speed rating may lead to tire damage and to the tires bursting.

- ▶ Therefore, only use tire types and sizes approved for your vehicle model.
- ▶ Observe the tire load rating and speed rating required for your vehicle.

**! NOTE** Vehicle and tire damage due to tire types and sizes that have not been approved

For safety reasons, only use tires, wheels and accessory parts which have been specially approved by Mercedes-Benz for your vehicle.

These tires have been specially adapted for use with driving systems and driving safety systems, such as ABS or ESP®.

Otherwise, certain properties, such as handling characteristics, vehicle noise emissions and consumption could be adversely affected. Other wheel sizes may cause the tires to come into contact with the vehicle body and axle components when under load. This may result in damage to the tire or the vehicle.

- ▶ Only use tires, wheels and accessory parts that have been checked and recommended by Mercedes-Benz.

**! NOTE** Driving safety put at risk by retreaded tires

Retreaded tires are not checked or recommended by Mercedes-Benz, as previous damage is not always detected during the retread process.

Driving safety cannot, therefore, be guaranteed.

- ▶ Do not use used tires when their previous usage is unknown.

Accessories that are not approved for your vehicle by Mercedes-Benz, or are not being used correctly, can impair operating safety.

Before purchasing and using non-approved accessories, visit a qualified specialist workshop and inquire about:

- suitability
- legal provisions
- factory recommendations

Observe the following points when selecting, installing and replacing tires:

- Use only tyres and wheels of the same type, design (winter tyres, all-season tyres) and make.
- Only install wheels of the same size and tread pattern on one axle (left and right).

It is only permissible to deviate from this in the event of a flat tire to drive to the specialist workshop.

- Only install tires of the correct size on the wheels.
- **Vehicles with a tire pressure monitoring system:** all installed wheels must be equipped with functioning sensors for the tire pressure monitoring system.
- At temperatures below 50 °F (10 °C), use winter tires or all-season tires marked M+S on all wheels.

Winter tires bearing the  snowflake symbol in addition to the M+S marking provide the best possible grip in wintry road conditions.

- Only use tires with the same tread pattern.
- Observe the maximum permissible speed for the mounted tires.

If this is below the vehicle's maximum permissible speed, this must be indicated on a label in the driver's field of vision.

- Break in new tires at moderate speeds for the first 60 miles (100 km).
- Replace the tires after six years at the latest, regardless of wear.

For more information on wheels and tires, contact a qualified specialist workshop.

#### **Vehicles with single tires:**

For vehicles with single tires and a GVWR of less than or equal to 9,480 lbs, only use tires of size LT 245/75 R16 that have been approved for this vehicle by the manufacturer. It is not permissible to use tires of different dimensions; doing so may lead to the general operating permit being rendered invalid.

Also observe the following further related subjects:

- Notes on tire pressure (→ page 190)
- Tire and Loading Information placard (→ page 195)
- Tire size designation, load capacity and speed rating (→ page 199)
- Tire pressure table (→ page 191)
- Notes on the emergency spare wheel (→ page 208)

### Notes on changing wheels

#### **WARNING** Risk of injury through different wheel sizes

Rotating the front and rear wheels can severely impair the driving characteristics.

The wheel brakes or suspension components may also be damaged.

- ▶ Rotate front and rear wheels only if the wheels and tires are of the same dimensions.

On vehicles that have the same size front and rear wheels, rotate the wheels according to the intervals in the tire manufacturer's warranty book in your vehicle documents. If this is not available, rotate the tires every 3,000 (5,000) to 6,000 miles (10,000 km), depending on the degree of wear. Ensure that the direction of rotation is maintained.

It is imperative to observe the instructions and safety notes on "Changing a wheel" when doing so.

### Information on the direction of the tires' rotation

Tires with a specified direction of rotation have additional benefits, e.g. if there is a risk of hydroplaning. You will only gain these benefits if the correct direction of rotation is observed.

An arrow on the sidewall of the tire indicates its correct direction of rotation.

You may also install a spare wheel against the direction of rotation. Observe the time restriction on use as well as the speed limitation specified on the spare wheel.

### Notes on storing wheels

Observe the following when storing wheels:

- Wheels that have been removed should be stored in a cool, dry and, if possible, dark place.
- Protect the tires from oil, grease and fuel.

### Overview of tire-change tool kit

Required tire-changing tools may include, for example:

- Jack
- Wheel wrench

- i** You will find the maximum load capacity of the jack stated on the adhesive label attached to the jack.  
The jack is maintenance-free. If there is a malfunction, please contact a qualified specialist workshop.

#### Vehicles with rear wheel drive

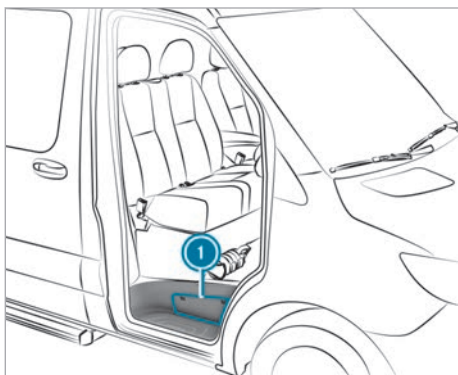

The tire-change tool kit is located in stowage compartment **1** above the step of the front passenger door and in the stowage compartment in the footwell on the front passenger side.

#### Preparing the vehicle for a wheel change

##### Requirements:

- The wheel-change tool kit is available.
  - There is a spare wheel available.
  - The vehicle is not on a slope.
  - The vehicle is on solid, non-slippery and level ground.
- ▶ Apply the parking brake.
  - ▶ Move the front wheels to the straight-ahead position.
  - ▶ Shift the transmission to position **P**.
  - ▶ Switch off the vehicle.
  - ▶ Make sure that the vehicle cannot be switched on.
  - ▶ Take the vehicle tool kit from the footwell on the front passenger side (→ page 185).

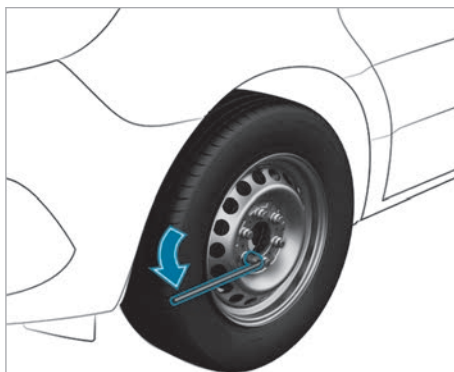

#### Vehicles with rear-wheel drive

- ▶ Take the jack and the tire-change tool kit out of the stowage compartment (→ page 203).
- ▶ If necessary, remove the wheel trim.
- ▶ Assemble the wheel wrench extension using the middle rod and the rod with the largest diameter from the three-part jack pump lever.
- ▶ Starting with the middle rod, slide the wheel wrench extension as far as it will go onto the wheel wrench.
- ▶ Using the wheel wrench, loosen the wheel nuts or bolts on the wheel you wish to change by about one full turn. Do not unscrew the wheel nuts or bolts completely.
- ▶ Raise the vehicle (→ page 204).

#### Raising the vehicle when changing a wheel

##### **⚠ WARNING** Risk of injury from incorrect positioning of the jack

If you do not position the jack correctly at the appropriate jacking point of the vehicle, the jack could tip with the vehicle raised.

- ▶ Only position the jack at the appropriate jacking point of the vehicle. The base of the jack must be positioned vertically under the jacking point of the vehicle.

##### **⚠ WARNING** Risk of injury from vehicle tipping

On slopes, the jack could tip with the vehicle raised.

- ▶ Never change a wheel on a slope.
- ▶ Consult a qualified specialist workshop.

**!** **NOTE** Damage to the vehicle due to the jack

If the jack has not been positioned at the prescribed jack support points, the vehicle may suffer damage.

▶ Only position the jack at the jack support points provided for this purpose.

#### Requirements:

- There is nobody in the vehicle.
- The vehicle is prepared for changing a wheel (→ page 204).

Only position the jack on the jack support points intended for this purpose. Otherwise you could damage the vehicle.

Important notes on using the jack:

- Only use the vehicle-specific jack that has been tested and approved by Mercedes-Benz to raise the vehicle. If the jack is used incorrectly, it could tip over while the vehicle is raised.
- The jack is designed only to raise the vehicle for a short time while a wheel is being changed and is not suitable for carrying out maintenance work under the vehicle.
- Avoid changing a wheel on uphill or downhill slopes.
- The jack must be placed on a firm, flat and non-slip surface. If necessary, use a large, flat, load-bearing and non-slip underlay.
- The foot of the jack must be positioned vertically under the jack support point.

Safety instructions while the vehicle is raised:

- Do not put your hands or feet under the vehicle.
- Do not lie underneath the vehicle.
- Do not start the vehicle and do not release the parking brake.
- Do not open or close any doors.

#### Vehicles with rear-wheel drive

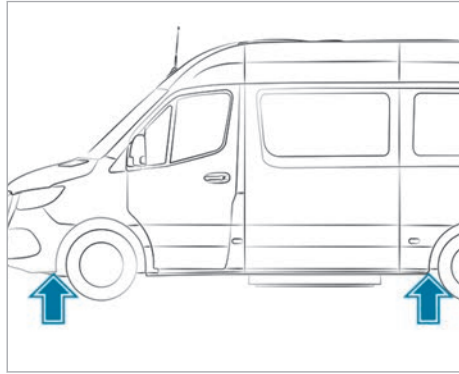

Jack support points

Only use the middle rod and the pump lever rod with the largest diameter for the jack as a wheel wrench extension. Only insert the middle rod on the wheel wrench, and always as far as it will go. Otherwise, the rods could bend and deform so much that they can no longer be used as pump levers for the jack.

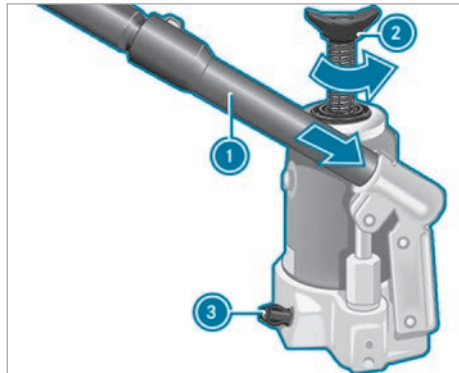

▶ **To prepare the hydraulic jack:** insert the third rod of the pump lever ① for the jack into the wheel wrench extension.

▶ Close the pressure release screw ③.

▶ To do this, use the flattened section on the pump lever ① to turn the pressure release screw ③ clockwise to the stop.

**i** Do not turn the pressure release screw ③ more than one or two full turns. Hydraulic fluid could otherwise escape.

- ▶ Insert the pump lever  with the largest rod into the recess on the jack and secure by turning it clockwise.
- ▶ Place the jack vertically beneath the jack support points described below.

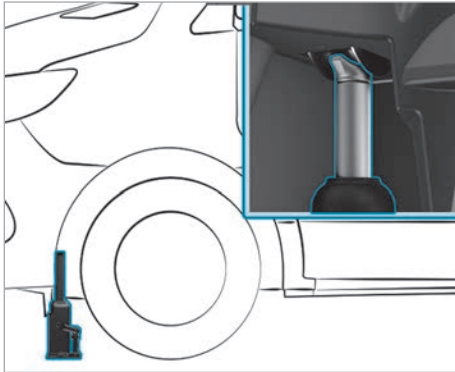

Jack support point, front axle

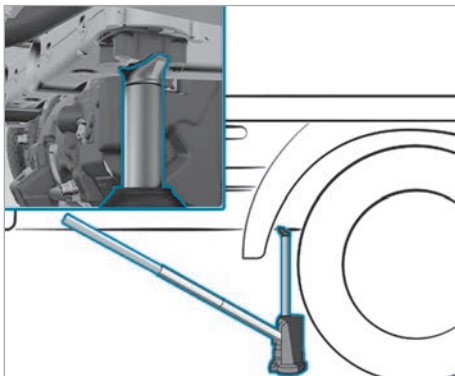

Jack support point, rear axle

- ▶ Place the jack beneath the jack support point.
- ▶ Raise the vehicle until the tire is raised a maximum of 1.2 in (3 cm) off the ground.
- ▶ Loosen and remove the wheel (→ page 206).

### Removing a wheel

#### Requirements:

- The vehicle is raised (→ page 204).

When changing a wheel, avoid applying any force to the brake disks since this could impair the level of comfort when braking.

**!** **NOTE** Damage to threading from dirt on wheel bolts

- ▶ Do not place wheel bolts in sand or on a dirty surface.

- ▶ Unscrew the wheel bolts or nuts with the wheel nut wrench.
- ▶ On front wheels with wheel nuts, remove the wheel nut cover.
- ▶ Remove the wheel.
- ▶ Install the new wheel (→ page 206)

### Installing a new wheel

#### Requirements:

- The wheel has been removed (→ page 206).

**!** **WARNING** Risk of accident from losing a wheel

Oiled, greased or damaged wheel bolt/wheel nut threads or wheel hub/wheel mounting bolt threads can cause the wheel bolts/wheel nuts to come loose.

- ▶ Never oil or grease the threads.
- ▶ In the event of damage to the threads, contact a qualified specialist workshop immediately.
- ▶ Have the damaged wheel bolts or damaged hub threads replaced.
- ▶ Do not continue driving.

**!** **WARNING** Risk of injury from tightening wheel bolts and nuts

If you tighten the wheel bolts or wheel nuts when the vehicle is raised, the jack could tip.

- ▶ Only tighten wheel bolts or wheel nuts when the vehicle is on the ground.

- ▶ Observe the instructions and safety notes on wheel-changing and the notes on tire selection (→ page 202).
- ▶ For safety reasons, only use wheel bolts or wheel nuts which have been approved by Mercedes-Benz and for the wheel in question.

When you install the steel spare wheel, it is essential you use the short wheel bolts for a steel wheel. Using other wheel bolts when installing the steel spare wheel may damage the brake system.

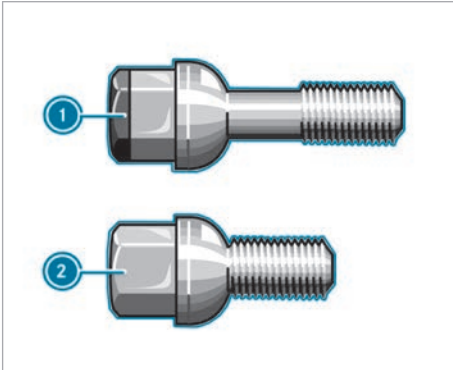

- ① Wheel bolt for light-alloy wheel
- ② Wheel bolt for steel wheel

- ▶ Clean the wheel and wheel hub contact surfaces.
- ▶ Slide the wheel which is to be installed onto the wheel hub and push it on.

#### Vehicles with steel wheels

- ▶ Use the short wheel bolts intended for the steel spare wheel, which are found in the vehicle tool kit.
- ▶ Screw in the wheel bolts until they are hand-tight.

#### Vehicles with light-alloy wheels

- ▶ Use the long wheel bolts intended for the light-alloy spare wheel, which are found in the vehicle tool kit.
- ▶ Screw in the wheel bolts until they are hand-tight.

#### Lowering the vehicle after a wheel change

**⚠ WARNING** Risk of accident due to incorrect tightening torque

The wheels could come loose if the wheel bolts or wheel nuts are not tightened to the prescribed torque.

- ▶ Ensure that the wheel bolts or wheel nuts are tightened to the prescribed tightening torque.
- ▶ If you are not sure, do not move the vehicle. Contact a qualified specialist workshop and have the tightening torque checked immediately.

#### Requirements:

- The new wheel has been installed (→ page 206).

Observe the notes on raising the vehicle (→ page 204).

#### Vehicles with rear-wheel drive

Only use the middle rod and the pump lever rod with the largest diameter for the jack as a lug wrench extension. Only insert the middle rod on the lug wrench, and always as far as it will go. Otherwise, the rods could bend and deform so much that they can no longer be used as pump levers for the jack.

- ▶ Using the pump lever, slowly turn the drain screw on the jack approximately one revolution and carefully lower the vehicle.
- ▶ Place the jack to one side.
- ▶ Pull the rod with the smallest diameter off the pump lever. The shortened pump lever serves as a lug wrench extension.
- ▶ Starting with the middle rod, slide the lug wrench extension as far as it will go onto the lug wrench.

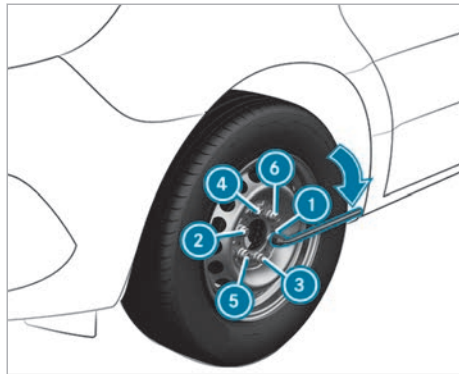

- ▶ Tighten the wheel bolts or nuts evenly in the sequence indicated (① to ⑥).  
Specified tightening torque:
  - Steel wheel bolts: 177 lb-ft (240 Nm)
  - Light alloy wheel bolts: 133 lb-ft (180 Nm)
- ▶ Push the piston on the hydraulic jack in again and close the pressure release screw.

- i** You can now install the hub caps on steel wheels with wheel bolts. The installing procedure depends on whether the hub cap acts as a trim that covers the whole wheel, or just covers the center.

▶ **Wheel with wheel trim:** position the opening in the wheel trim for the tire valve over the tire valve.

▶ Push the edge of the hub cap onto the wheel rim with both hands until it engages into place. Make sure the hub cap retaining catches engage on the steel wheel.

▶ **Wheel with central hub cap:** position the retaining lugs of the central hub cap over the wheel bolts.

▶ Hit the middle of the hub cap to engage it on the wheel.

▶ Secure the faulty wheel in the spare wheel holder.

▶ Check the tire pressure of the newly installed wheel and adjust it if necessary.

▶ Retighten the wheel bolts or wheel nuts to the specified tightening torque after the vehicle has been driven 31 miles (50 km).

▶ When using a wheel or spare wheel with a new or newly painted wheel rim, have the wheel bolts or wheel nuts retightened after approximately 620 miles (1,000 km) to 3,100 miles (5,000 km).

- i** **Vehicles with a tire pressure monitoring system:** all wheels installed must be equipped with functioning sensors.

Make sure to observe the following further related subject:

- Notes on tire pressure (→ page 190)

## Spare wheel

### Notes on the emergency spare wheel and spare wheel

**Emergency spare wheel:** wheel and/or tire dimensions as well as the type of tire are different from the wheel to be replaced.

- i** A label with the speed limitation can be found on the emergency spare wheel.

**Spare wheel:** wheel and tire dimensions as well as the type of tire correspond to the other installed wheels.

A installed emergency spare wheel or spare wheel changes the driving characteristics and bears risks.

### **⚠ WARNING** Risk of accident due to incorrect wheel and tire dimensions

Mounting an emergency spare wheel or spare wheel may severely impair the driving characteristics.

There is an increased risk of an accident.

To prevent hazardous situations:

- ▶ Check the tire pressure of the spare wheel or emergency spare wheel once installed and, if necessary, adjust.
- ▶ The emergency spare wheel may only be used temporarily and must be replaced with a standard wheel as soon as possible.
- ▶ Never install more than one emergency spare wheel.
- ▶ Adapt your driving style and drive carefully in emergency spare wheel mode.
- ▶ Do not switch off ESP®.
- ▶ Do not use snow chains on the emergency spare wheel.
- ▶ Replace the emergency spare wheel after six years at the latest, regardless of wear.

- When using an emergency spare wheel or spare wheel (different from the wheel to be replaced), you must not exceed a permissible top speed of 50 mph (80 km/h).
- Have the emergency spare wheel or spare wheel replaced by a qualified specialist workshop (→ page 202).
- The tire pressure of the emergency spare wheel or spare wheel must be checked before starting a journey and, if necessary, adjusted (→ page 191).

The following should be checked regularly, particularly prior to long journeys:

- that the emergency spare wheel or spare wheel is firmly secured
- the tire pressure of the emergency spare wheel or spare wheel (adjust the tire pressure if necessary) (→ page 191)
- the fastenings of the emergency spare wheel holder or spare wheel holder

The spare wheel is located either in the load compartment or in a spare wheel holder under the vehicle.

Replace the tires after six years at the latest, regardless of wear. This also applies to the spare wheel.

- ❗ If you have installed an emergency spare wheel or a spare wheel, the tire pressure monitoring system will not function for this wheel. The emergency spare wheel or spare wheel is not equipped with a sensor for the tire pressure monitoring system.

### Installing and removing the spare wheel

#### Vehicles with rear-wheel drive: removing the spare wheel (Panel Van or Tourer)

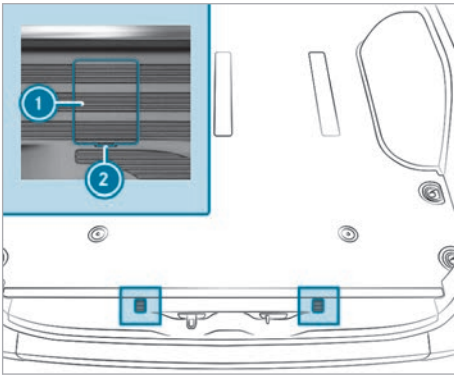

Bolt covers for the retaining hooks (example: Panel Van)

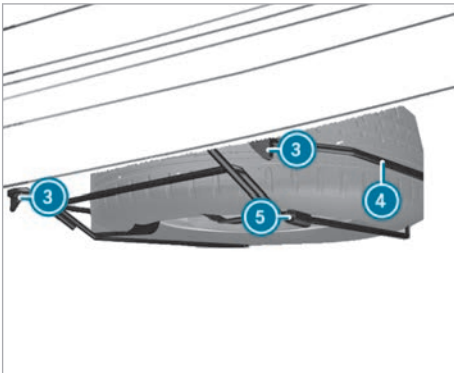

- ▶ Open the rear-end doors.

- ▶ Place a screwdriver into the recesses ② and pry off the covers ①.
- ▶ Using the wheel wrench from the vehicle tool kit, unscrew the now visible bolts counter-clockwise by approximately 20 turns.
- ▶ Slightly raise the spare wheel carrier ④ and unhook the left-hand retaining hook ③.
- ▶ Assemble the pump lever for the jack and slide it into the sleeve ⑤ on the right-hand side of the spare wheel carrier ④.
- ▶ Raise the spare wheel carrier ④ with the pump lever and unhook the right-hand retaining hook ③.
- ▶ Slowly lower the spare wheel carrier ④ to the ground.
- ▶ Lift the spare wheel carrier ④ slightly and pull the pump lever out of the sleeve.
- ▶ Use the pump lever to lift the spare wheel beyond the rear edge of the spare wheel carrier ④.
- ▶ Carefully remove the spare wheel from the spare wheel carrier ④. The spare wheel is heavy. When the spare wheel is removed, the center of gravity changes due to the heavy weight of the wheel. The spare wheel may slip down or tip over.

#### Vehicles with rear-wheel drive: installing the spare wheel (Panel Van or Tourer)

- ▶ Carefully place the spare wheel onto the spare wheel carrier ④. The spare wheel is heavy. When you place the spare wheel onto the spare wheel carrier ④, the center of gravity changes due to the weight of the wheel. The spare wheel may slip down or tip over.
- ▶ Slide the pump lever for the jack into the sleeve ⑤ on the spare wheel carrier ④.
- ▶ Raise the spare wheel carrier ④ with the pump lever and attach the right-hand retaining hook ③.
- ▶ Slightly raise the spare wheel carrier ④ and attach the left-hand retaining hook ③.
- ▶ Pull the pump lever out of the sleeve ⑤.
- ▶ Using the wheel wrench, tighten the bolts for the retaining hooks ③ by turning them clockwise.
- ▶ Replace and engage the covers ①.
- ▶ Close the rear-end doors.

### Vehicles with rear-wheel drive: removing the spare wheel (vehicle with lowered chassis)

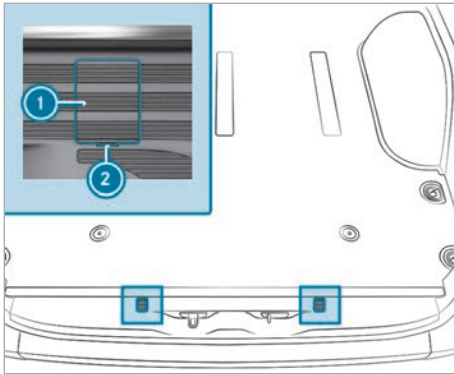

Bolt covers for the retaining hooks (example: Panel Van)

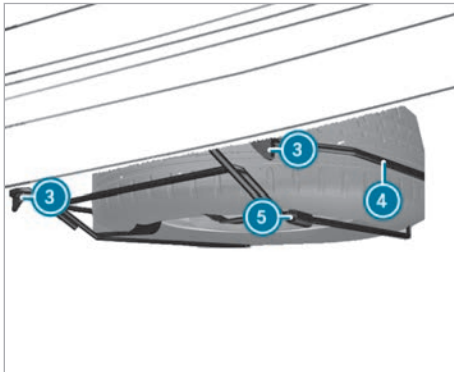

- ▶ Open the rear-end doors.
- ▶ Place a screwdriver into the recesses (2) and pry off the covers (1).
- ▶ Using the wheel wrench from the vehicle tool kit, unscrew the now visible bolts counter-clockwise by approximately 20 turns.
- ▶ Slightly raise the spare wheel carrier (4) and unhook the left-hand retaining hook (3).
- ▶ Assemble the pump lever for the jack and slide it into the sleeve (5) on the right-hand side of the spare wheel carrier (4).
- ▶ Raise the spare wheel carrier with the pump lever and unhook the right-hand retaining hook (3).
- ▶ Prepare the jack.

- ▶ Place the jack beneath the corresponding jack support point.
- ▶ Move the pump lever up and down until the tire is raised a maximum of 1.18 in (3 cm) off the ground.
- ▶ Carefully remove the spare wheel from the spare wheel carrier (4). The spare wheel is heavy. When the spare wheel is removed, the center of gravity changes due to the heavy weight of the wheel. The spare wheel may slip down or tip over.
- ▶ Install the spare wheel on the vehicle.
- ▶ Lower the vehicle.

### Vehicles with rear-wheel drive: installing the spare wheel (vehicle with lowered chassis)

- ▶ **i** In the event of a flat tire, you may only store the defective wheel inside the vehicle. An intact wheel may be stored in the spare wheel carrier only when the vehicle is unladen. A laden vehicle must first be raised.
- ▶ Carefully place the spare wheel onto the spare wheel carrier (4). The spare wheel is heavy. When you place the spare wheel onto the spare wheel carrier (4), the center of gravity changes due to the weight of the wheel. The spare wheel may slip down or tip over.
- ▶ Slide the pump lever for the jack into the sleeve (5) on the spare wheel carrier (4).
- ▶ Raise the spare wheel carrier (4) with the pump lever and attach the right-hand retaining hook (3).
- ▶ Slightly raise the spare wheel carrier (4) and attach the left-hand retaining hook (3).
- ▶ Pull the pump lever out of the sleeve (5).
- ▶ Using the wheel wrench, tighten the bolts for the retaining hooks (3) by turning them clockwise.
- ▶ Replace and engage the covers (1).
- ▶ Close the rear-end doors.

### Vehicles with rear-wheel drive: removing the spare wheel (chassis)

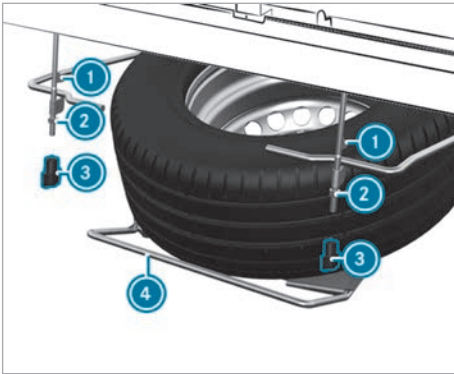

- ▶ Loosen the wing nuts (3) manually and remove them.
- ▶ Loosen the nuts (2) as far as the thread end.
- ▶ Slightly raise the spare wheel carrier (4) and unhook the left-hand retaining hook (1).
- ▶ Assemble the pump lever for the jack and slide it into the sleeve on the right-hand side of the spare wheel carrier (4).
- ▶ Raise the spare wheel carrier (4) with the pump lever and unhook the right-hand retaining hook (1).
- ▶ Slowly lower the spare wheel carrier (4) to the ground.
- ▶ Lift the spare wheel carrier (4) slightly and pull the pump lever out of the sleeve.
- ▶ Use the pump lever to lift the spare wheel beyond the rear edge of the spare wheel carrier.
- ▶ Carefully remove the spare wheel from the spare wheel carrier. The spare wheel is heavy. When the spare wheel is removed, the center of gravity changes due to the heavy weight of the wheel. The spare wheel may slip down or tip over.

### Vehicles with rear-wheel drive: installing the spare wheel (chassis)

- ▶ Carefully place the spare wheel onto the spare wheel carrier (4). The spare wheel is heavy. When you place the spare wheel onto the spare wheel carrier, the center of gravity changes due to the weight of the wheel. The spare wheel may slip down or tip over.

- ▶ Slide the pump lever for the jack into the sleeve on the spare wheel carrier (4).
- ▶ Raise the spare wheel carrier (4) with the pump lever and attach the right-hand retaining hook (1).
- ▶ Slightly raise the spare wheel carrier and attach the left-hand retaining hook (1).
- ▶ Pull the pump lever out of the sleeve.
- ▶ Tighten the nuts (2).
- ▶ Put the wing nuts (3) in place and tighten them.

**Information on the technical data**

The given data only applies to vehicles with standard equipment. You can obtain further information at a qualified specialist workshop.

**On-board electronics**

**Notes on work on the engine electronics**

**! NOTES** Premature wear through improper maintenance

Improper maintenance may cause vehicle components to wear more quickly and the vehicle's operating permit may be invalidated.

- ▶ Always have work on the engine electronics and related components carried out at a qualified specialist workshop.

**Two-way radios**

**Installation notes for two-way radios**

**⚠ WARNING** Risk of accident due to improper work on two-way radios

If two-way radios are manipulated or retrofitted incorrectly, the electromagnetic radiation from the two-way radios can interfere with the vehicle electronics and jeopardize the operating safety of the vehicle.

- ▶ You should have all work on electrical and electronic components carried out at a qualified specialist workshop.

**⚠ WARNING** Risk of accident due to improper operation of two-way radios

If you use two-way radios in the vehicle improperly, their electromagnetic radiation can disrupt the vehicle's electronics. This is the case in the following situations, in particular:

- The two-way radio is not connected to an exterior antenna.
- The exterior antenna is installed incorrectly or is not a low-reflection antenna.

This could jeopardize the operating safety of the vehicle.

- ▶ Have the low-reflection exterior antenna installed at a qualified specialist workshop.

- ▶ When operating two-way radios in the vehicle, always connect them to the low-reflection exterior antenna.

**! NOTE** Invalidation of the operating permit due to failure to comply with the instructions for installation and use

The operating permit may be invalidated if the instructions for installation and use of two-way radios are not observed.

- ▶ Only use approved frequency bands.
- ▶ Observe the maximum permissible output power in these frequency bands.
- ▶ Only use approved antenna positions.

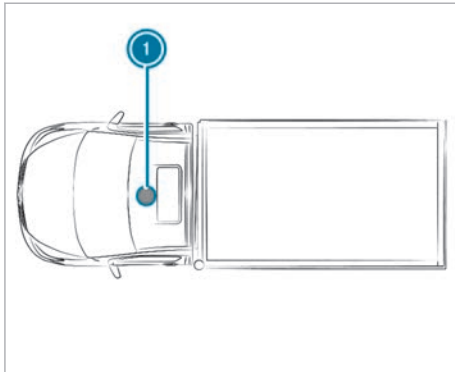

Cab Chassis (standard cab)

① Front roof area

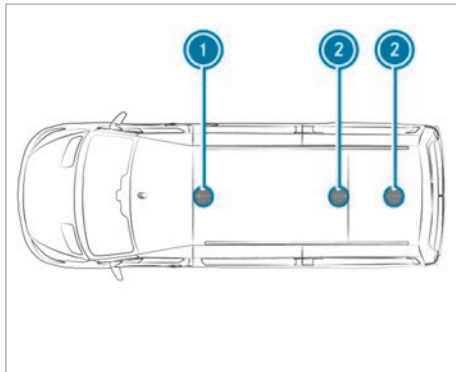

Cargo Van

① Front roof area

② Rear roof area

Use Technical Specification ISO/TS 21 609 (Road Vehicles - EMC guidelines for installation of after-market radio frequency transmitting equipment) when retrofitting two-way radios. Comply with the legal requirements for detachable parts.

If your vehicle has pre-installation for two-way radio equipment, use the power supply or antenna connections intended for use with the pre-installation. Observe the manufacturer's supplements during installation.

**Transmission output of two-way radios**

The maximum transmission outputs (PEAK) at the base of the antenna must not exceed the values in the following table:

**Frequency band and maximum transmission output**

| Frequency band                                     | Maximum transmission output |
|--|-----------------------------|
| 2-m- frequency band<br>144 - 174 MHz               | 50 W                        |
| 4-m-frequency band<br>74 - 88 MHz                  | 30 W                        |
| Terrestrial Trunked Radio (TETRA)<br>380 - 460 MHz | 10 W                        |
| Mobile telephony<br>2G                             | 2 W                         |
| Mobile telephony<br>3G/4G/5G                       | 0.5 W                       |

There are no restrictions on use of the following devices in the vehicle:

- Two-way radios with a maximum transmission output of up to 100 mW
- Two-way radios with transmitter frequencies in the 380-410 MHz frequency band and a maximum transmission output of up to 2 W (trunked radio system/Tetra)
- Mobile phones (2G/3G/4G/5G)

There are no restrictions on positioning the antenna on the outside of the vehicle for the following frequency bands:

- Terrestrial Trunked Radio (TETRA)
- 2G/3G/4G/5G

**Radio regulations**

**Regulatory radio identifiers and specific notes**

The tables and sections contain the following regulatory radio information:

- Manufacturer information
- Required regulatory radio identifiers, listed by country/region:
  - Manufacturer's specifications
  - Model designations
  - Radio equipment approval numbers
- Specific information on wireless components

Further information and updates are available at the following web address:

<https://regulatoryradioinformation.corpinter.net/vans/us>



**Manufacturer overview**

| Manufacturer                        | Manufacturer information   |
|-------------------------------------|--|
| ADC                                 | ADC Automotive Distance Control Systems GmbH, Peter-Dornier-Straße 10, 88131 Lindau, Germany |
| Bosch                               | Robert Bosch GmbH, Daimlerstraße 6, 71229 Leonberg, Germany                                  |
| Continental Automotive              | Continental Automotive GmbH, Siemensstraße 12, 93055 Regensburg, Germany                     |
| Continental Automotive Technologies | Continental Automotive Technologies GmbH, VDO-Straße 1, 64832 Babenhausen, Germany           |
| Garmin                              | Garmin International, Inc., 1200 E. 151st Street, Olathe, Kansas 66062, United States        |

| Manufacturer       | Manufacturer information   |
|--------------------|--|
| Harman Becker      | Harman Becker Automotive Systems GmbH, Becker-Goehring-Straße 18, 76307 Karlsbad, Germany                      |
| HELLA              | HELLA KGaA Hueck & Co., Rixbecker Straße 75, 59552 Lippstadt, Germany  |
| Hirschmann         | Hirschmann Car Communication GmbH, Stuttgarter Straße 45-51, 72654 Neckartenzlingen, Germany                   |
| Huf Baolong        | Huf Baolong Electronics Bretten GmbH, Gewerbestraße 40, 75015 Bretten, Germany                                 |
| MARQUARDT          | MARQUARDT GmbH, Schloßstraße 16, 78604 Rietheim-Weilheim, Germany  |
| Meta System        | Meta System S.P.A., Via T. Galimberti 5, 42124 Reggio Emilia, Italy  |
| Molex Technologies | Molex Technologies GmbH, Mizarstraße 3, 12529 Schönefeld, Germany  |
| Schrader           | Schrader Electronics Ltd., 11 Technology Park, Belfast Road, Antrim BT41 1QS, Northern Ireland, United Kingdom |
| Veoneer            | Veoneer Sweden AB, Wallentinsvägen 22, 44737 Vårgårda, Sweden  |

| Manufacturer  | Manufacturer information   |
|---------------|--|
| Visteon       | Visteon Electronics GmbH, Amalienbadstraße 41a, 76227 Karlsruhe, Germany |
| WITTE-Velbert | WITTE-Velbert GmbH & Co. KG, Hoefenstr. 3-15, 42551 Velbert, Germany     |

#### Algeria

|   |
|---|
| <p><b>Agréé par l'ANF</b><br/> <b>Référence du Certificat de conformité</b></p> |
|---|

|  |
|--|
| <p><b>Homologué par l'ARPC</b><br/> <b>Référence du Certificat de conformité</b></p> |
|--|

#### Regulatory radio identification

| Manufacturer           | Model designation              | Radio equipment approval number |
|------------------------|--------------------------------|---------------------------------|
| Continental Automotive | MARS Keyless (locking system)  | 122/H/ANF/2021                  |
| HELLA                  | DM4 (locking system)           | 123/H/ANF/2021                  |
| Hirschmann             | 920510A (locking system)       | 4001/1.69-DA/3005/DT/DG/ARPT/17 |
| Huf Baolong            | TSSRE4A (tire pressure sensor) | 198/H/ANF/2021                  |

| Manufacturer | Model designation  | Radio equipment approval number |
|--------------|--|---------------------------------|
| Huf Baolong  | TSSSG4G6b (tire pressure monitoring system control unit) | 67/H/ANF/2021                   |
| MARQUARDT    | DC12B (locking system)                                   | 189/H/ANF/2021                  |

### Argentina

#### Regulatory radio identification

|  |                                |                                 |
|---|--------------------------------|---------------------------------|
| Manufacturer  | Model designation              | Radio equipment approval number |
| Continental Automotive  | MARS Keyless (locking system)  | H-17929                         |
| Huf Baolong   | TSSRE4A (tire pressure sensor) | H-20027                         |
| Hirschmann  | 920510A (locking system)       | H-21033                         |
| MARQUARDT   | DC12B (locking system)         | H-21034                         |
| MARQUARDT   | MS2 (locking system)           | H-17598                         |
| Schrader  | HSW4T (tire pressure sensor)   | H-12336                         |

### Australia

#### Regulatory radio identification

|  |  |
|---|--|
| Manufacturer  | Model designation  |
| ADC   | SRR6-A (control unit)                                    |
| Bosch   | MRR1Rear (radar sensor)                                  |
| Bosch   | MRRe14FCR (radar sensor)                                 |
| Bosch   | FR5CPCCF (radar sensor)                                  |
| Bosch   | F5CP12 (radar sensor)                                    |
| Continental Automotive  | MARS Keyless (locking system)                            |
| Continental Automotive Technologies   | NTG7Q MID LF2 (head unit)                                |
| Continental Automotive Technologies   | NTG7Q HIGH LF2 (head unit)                               |
| Continental Automotive Technologies   | NTG7Q PREMIUM LF2 (head unit)                            |
| Huf Baolong   | TSSRE4Uf (tire pressure sensor)                          |
| Huf Baolong   | TSSSG4G6b (tire pressure monitoring system control unit) |

### Bahamas

#### Regulatory radio identification

| Manufacturer | Model designation        | Radio equipment approval number |
|--------------|--------------------------|---------------------------------|
| Bosch        | MRR1Rear (radar sensor)  | URCA_TA/2017_184                |
| Bosch        | MRRe14FCR (radar sensor) | URCA_TA/2017_157                |
| Bosch        | FR5CPCCF (radar sensor)  | URCA_TA_2019_195                |

| Manufacturer           | Model designation              | Radio equipment approval number |
|------------------------|--------------------------------|---------------------------------|
| Bosch                  | F5CP12 (radar sensor)          | URCA_TA_2022_077                |
| Continental Automotive | MARS Keyless (locking system)  | URCA_TA/2017_119                |
| HELLA                  | DM4 (locking system)           | URCA_TA/2017_078                |
| Hirschmann             | 920510A (locking system)       | URCA_TA/2019_019                |
| Huf Baolong            | TSSRE4A (tire pressure sensor) | URCA_TA/2017_094                |
| MARQUARDT              | DC12B (locking system)         | URCA_TA_2019_128                |
| MARQUARDT              | MS2 (locking system)           | URCA_TA/2017_021                |

#### Belarus

##### Regulatory radio identification

|  |                                 |
|--|---------------------------------|
| Manufacturer   | Model designation               |
| Bosch  | MRR1Rear (radar sensor)         |
| Bosch  | MRRre14FCR (radar sensor)       |
| Bosch  | FR5CPCCF (radar sensor)         |
| Bosch  | F5CP12 (radar sensor)           |
| Continental Automotive   | MARS Keyless (locking system)   |
| HELLA  | DM4 (locking system)            |
| Huf Baolong  | TSSRE4A (tire pressure sensor)  |
| Huf Baolong  | TSSRE4Uf (tire pressure sensor) |



| Manufacturer | Model designation  |
|--------------|--|
| Huf Baolong  | TSSSG4G6b (tire pressure monitoring system control unit) |
| MARQUARDT    | DC12B (locking system)                                   |
| MARQUARDT    | MS2 (locking system)                                     |

#### Botswana

##### Regulatory radio identification

| Manufacturer           | Model designation               | Radio equipment approval number |
|------------------------|---------------------------------|---------------------------------|
| Bosch                  | MRRre14FCR (radar sensor)       | BOCRA/TA/2019/4674              |
| Bosch                  | FR5CPCCF (radar sensor)         | BOCRA/TA/2019/4975              |
| Bosch                  | MRR1Rear (radar sensor)         | BOCRA/TA/2017/3788              |
| Bosch                  | F5CP12 (radar sensor)           | BOCRA/TA/2022/7110              |
| Continental Automotive | MARS Keyless (locking system)   | BOCRA/TA/2019/4661              |
| HELLA                  | DM4 (locking system)            | BOCRA/TA/2019/4662              |
| Huf Baolong            | TSSRE4Uf (tire pressure sensor) | BOCRA/TA/2019/5079              |
| MARQUARDT              | DC12B (locking system)          | BOCRA/TA/2019/4388              |
| MARQUARDT              | MS2 (locking system)            | BOCRA/TA/2019/5135              |

#### Brazil

##### Note on the two-way radio systems in the vehicle:

These systems are not protected against harmful interference and must not cause interference in properly approved systems.

## Regulatory radio identification

|  |                                   |                                 |
|---|-----------------------------------|---------------------------------|
| Manufacturer  | Model designation                 | Radio equipment approval number |
| ADC   | SRR6-A (control unit)             | 00512-24-02496                  |
| Continental Automotive  | MARS Keyless (locking system)     | 03189-17-02856                  |
| Continental Automotive Technologies   | NTG7Q MID LF2 (head unit)         | 04336-23-02149                  |
| Continental Automotive Technologies   | NTG7Q HIGH LF2 (head unit)        | 04338-23-02149                  |
| Continental Automotive Technologies   | NTG7Q PRE-MIUM LF2 (head unit)    | 04337-23-02149                  |
| HELLA   | DM4 (locking system)              | 04689-17-05364                  |
| Hirschmann  | 920510A (locking system)          | 20595-22-08058                  |
| Huf Baolong   | TSSRE4A (tire pressure sensor)    | 05181-17-06643                  |
| Huf Baolong   | TSSRE4Uf (tire pressure sensor)   | 07137-19-08137                  |
| MARQUARDT   | DC12B (locking system)            | 01395-11-02930                  |
| MARQUARDT   | MS2 (locking system)              | 00616-17-02930                  |
| Molex Technologies  | HUB-8 (charger for mobile phones) | 19286-23-12116                  |

## Brunei Darussalam

## Regulatory radio identification

|  |  |                                 |
|---|--|---------------------------------|
| Manufacturer  | Model designation  | Radio equipment approval number |
| Bosch   | FR5CPCCF (radar sensor)                                  | DTA-004222                      |
| Bosch   | LRR3 (radar sensor)                                      | DTA-011039                      |
| Bosch   | MRR1Rear (radar sensor)                                  | DTA-006601                      |
| Bosch   | MRRe14FCR (radar sensor)                                 | DTA-006678                      |
| Bosch   | F5CP12 (radar sensor)                                    | DTA-018042                      |
| Continental Automotive  | MARS Keyless (locking system)                            | DTA-017264                      |
| HELLA   | DM4 (locking system)                                     | DTA-020187                      |
| Hirschmann  | 920510A (locking system)                                 | DTA-000718                      |
| Huf Baolong   | TSSRE4A (tire pressure sensor)                           | DTA-000310                      |
| Huf Baolong   | TSSRE4Uf (tire pressure sensor)                          | DTA-021806                      |
| Huf Baolong   | TSSSG4G6b (tire pressure monitoring system control unit) | DTA-003757                      |
| MARQUARDT   | DC12B (locking system)                                   | DTA-000068                      |
| MARQUARDT   | MS2 (locking system)                                     | LPD-38890                       |

## Eurasian Economic Union

## Regulatory radio identification

|  |  |
|---|--|
| Manufacturer  | Model designation  |
| Bosch   | FR5CPCCF (radar sensor)                                  |
| Bosch   | LRR3 (radar sensor)                                      |
| Bosch   | MRR1Rear (radar sensor)                                  |
| Bosch   | MRRre14FCR (radar sensor)                                |
| Bosch   | F5CP12 (radar sensor)                                    |
| Continental Automotive  | MARS Keyless (locking system)                            |
| HELLA   | DM4 (locking system)                                     |
| Hirschmann  | 920510A (locking system)                                 |
| Huf Baolong   | TSSRE4A (tire pressure sensor)                           |
| Huf Baolong   | TSSRE4Uf (tire pressure sensor)                          |
| Huf Baolong   | TSSSG4G6b (tire pressure monitoring system control unit) |
| MARQUARDT   | DC12B (locking system)                                   |
| MARQUARDT   | MS2 (locking system)                                     |

## Ghana





## Regulatory radio identification

| Manufacturer | Model designation       | Radio equipment approval number |
|--------------|-------------------------|---------------------------------|
|              |                         | NCA APPROVED                    |
| Bosch        | FR5CPCCF (radar sensor) | ZRO-M8-7E3-230                  |

| Manufacturer                        | Model designation               | Radio equipment approval number |
|-------------------------------------|---------------------------------|---------------------------------|
| Bosch                               | F5CP12 (radar sensor)           | 7E6-M1-X9B-SRD                  |
| Continental Automotive              | MARS Keyless (locking system)   | BR3-1M-GE2-16A                  |
| Continental Automotive Technologies | NTG7Q MID LF2 (head unit)       | 7M-7E7-X09-DSR                  |
| Continental Automotive Technologies | NTG7Q HIGH LF2 (head unit)      | 7M-7E7-X05-DSR                  |
| Continental Automotive Technologies | NTG7Q PRE-MIUM LF2 (head unit)  | 7M-7E7-X03-DSR                  |
| HELLA                               | DM4 (locking system)            | BR3-1M-GE2-157                  |
| Huf Baolong                         | TSSRE4A (tire pressure sensor)  | SR0-1M-7E4-24B                  |
| Huf Baolong                         | TSSRE4Uf (tire pressure sensor) | 7E5-7M-XCB-RDR                  |
| MARQUARDT                           | DC12B (locking system)          | ZRO-M8-7E3-X51                  |
| MARQUARDT                           | MS2 (locking system)            | BR3-1M-GE-129                   |









Indonesia









Regulatory radio identification







| Manufacturer | Model designation        | Radio equipment approval number   |
|--------------|--------------------------|---|
| Bosch        | LRR3 (radar sensor)      | 74264/<br>SDPPI/2021<br>7163<br>   |
| Bosch        | MRR1Rear (radar sensor)  | 74267/<br>SDPPI/2021<br>7163<br>   |
| Bosch        | MRRevo14F (radar sensor) | 74265/<br>SDPPI/2021<br>7163<br>  |
| Bosch        | MRRe14FCR (radar sensor) | 74266/<br>SDPPI/2021<br>7163<br> |



| Manufacturer | Model designation       | Radio equipment approval number  |
|--------------|-------------------------|--|
| Bosch        | FR5CPCCF (radar sensor) | 67882/<br>SDPPI/2020<br>7163<br><br>Dilarang melakukan perubahan spesifikasi yang dapat menimbulkan gangguan fisik dan/atau elektromagnetik terhadap lingkungan sekitarnya<br> |
| Bosch        | F5CP12 (radar sensor)   | 86858/<br>SDPPI/2022<br>84754<br><br>Dilarang melakukan perubahan spesifikasi yang dapat menimbulkan gangguan fisik dan/atau elektromagnetik terhadap lingkungan sekitarnya  |



| Manufacturer                        | Model designation             | Radio equipment approval number   | Manufacturer                        | Model designation              | Radio equipment approval number   |
|-------------------------------------|-------------------------------|---|-------------------------------------|--------------------------------|---|
| Continental Automotive              | MARS Keyless (locking system) | 69379 / SDPPI/2020 7163<br><br>Dilarang melakukan perubahan spesifikasi yang dapat menimbulkan gangguan fisik dan/atau elektromagnetik terhadap lingkungan sekitarnya<br>     | Continental Automotive Technologies | NTG7Q HIGH LF2 (head unit)     | 88579 / SDPPI/2023 7163<br><br>Dilarang melakukan perubahan spesifikasi yang dapat menimbulkan gangguan fisik dan/atau elektromagnetik terhadap lingkungan sekitarnya<br>     |
| Continental Automotive Technologies | NTG7Q MID LF2 (head unit)     | 88477 / SDPPI/2023 7163<br><br>Dilarang melakukan perubahan spesifikasi yang dapat menimbulkan gangguan fisik dan/atau elektromagnetik terhadap lingkungan sekitarnya<br> | Continental Automotive Technologies | NTG7Q PRE-MIUM LF2 (head unit) | 88478 / SDPPI/2023 7163<br><br>Dilarang melakukan perubahan spesifikasi yang dapat menimbulkan gangguan fisik dan/atau elektromagnetik terhadap lingkungan sekitarnya<br> |

| Manufacturer     | Model designation   | Radio equipment approval number  | Manufacturer     | Model designation   | Radio equipment approval number |
|------------------|---|--|------------------|---|---------------------------------|
| Garmin           | VIS (head unit)   | 69984/<br>SDPPI/2020<br>7163<br><br>Dilarang melakukan perubahan spesifikasi yang dapat menimbulkan gangguan fisik dan/atau elektromagnetik terhadap lingkungan sekitarnya<br>     | Harman<br>Becker | NTG6N HIGH<br>(head unit)<br>Production:<br>Germany<br><br>Dilarang melakukan perubahan spesifikasi yang dapat menimbulkan gangguan fisik dan/atau elektromagnetik terhadap lingkungan sekitarnya<br>             |                                 |
| Harman<br>Becker | NTG6N<br>ENTRY/MID<br>(head unit)<br>Production:<br>Germany | 64019/<br>SDPPI/2019<br>7163<br><br>Dilarang melakukan perubahan spesifikasi yang dapat menimbulkan gangguan fisik dan/atau elektromagnetik terhadap lingkungan sekitarnya<br> | Harman<br>Becker | NTG6N<br>ENTRY/MID<br>(head unit)<br>Production:<br>Hungary<br><br>Dilarang melakukan perubahan spesifikasi yang dapat menimbulkan gangguan fisik dan/atau elektromagnetik terhadap lingkungan sekitarnya<br> |                                 |

| Manufacturer     | Model designation                                   | Radio equipment approval number  | Manufacturer     | Model designation                | Radio equipment approval number  |
|------------------|---|--|------------------|----------------------------------|--|
| Harman<br>Becker | NTG6N HIGH<br>(head unit)<br>Production:<br>Hungary | 63774/<br>SDPPI/2019<br>7163<br><br>Dilarang melakukan perubahan spesifikasi yang dapat menimbulkan gangguan fisik dan/atau elektromagnetik terhadap lingkungan sekitarnya<br>     | Harman<br>Becker | NTG7 HIGH<br>(head unit)         | 70513/<br>SDPPI/2020<br>7163<br><br>Dilarang melakukan perubahan spesifikasi yang dapat menimbulkan gangguan fisik dan/atau elektromagnetik terhadap lingkungan sekitarnya<br>     |
| Harman<br>Becker | NTG7 MID<br>(head unit)                             | 65544/<br>SDPPI/2020<br>7163<br><br>Dilarang melakukan perubahan spesifikasi yang dapat menimbulkan gangguan fisik dan/atau elektromagnetik terhadap lingkungan sekitarnya<br> | Harman<br>Becker | NTG7 PRE-<br>MIUM (head<br>unit) | 65543/<br>SDPPI/2020<br>7163<br><br>Dilarang melakukan perubahan spesifikasi yang dapat menimbulkan gangguan fisik dan/atau elektromagnetik terhadap lingkungan sekitarnya<br> |

| Manufacturer     | Model designation                     | Radio equipment approval number  | Manufacturer | Model designation           | Radio equipment approval number  |
|------------------|---------------------------------------|--|--------------|-----------------------------|--|
| Harman<br>Becker | NTG7 PRE-<br>MIUM PLUS<br>(head unit) | 70512/<br>SDPPI/2020<br>7163<br><br><br><br>Dilarang melakukan perubahan spesifikasi yang dapat menimbulkan gangguan fisik dan/atau elektromagnetik terhadap lingkungan sekitarnya<br><br>     | Hirschmann   | 920510A<br>(locking system) | 81434/<br>SDPPI/2022<br>7163<br><br><br><br>Dilarang melakukan perubahan spesifikasi yang dapat menimbulkan gangguan fisik dan/atau elektromagnetik terhadap lingkungan sekitarnya<br><br>     |
| Harman<br>Becker | NTG7 RSU<br>(control unit)            | 66387/<br>SDPPI/2020<br>7163<br><br><br><br>Dilarang melakukan perubahan spesifikasi yang dapat menimbulkan gangguan fisik dan/atau elektromagnetik terhadap lingkungan sekitarnya<br><br> | HELLA        | DM4 (locking system)        | 69378/<br>SDPPI/2020<br>7163<br><br><br><br>Dilarang melakukan perubahan spesifikasi yang dapat menimbulkan gangguan fisik dan/atau elektromagnetik terhadap lingkungan sekitarnya<br><br> |

| Manufacturer | Model designation              | Radio equipment approval number   |
|--------------|--------------------------------|---|
| Huf Baolong  | TSSRE4A (tire pressure sensor) | 72438 / SDPPI/2021 7163<br>  |
| MARQUARDT    | DC12B (locking system)         | 59840 / SDPPI/2019 7163<br><br>Dilarang melakukan perubahan spesifikasi yang dapat menimbulkan gangguan fisik dan/atau elektromagnetik terhadap lingkungan sekitarnya<br> |

| Manufacturer | Model designation    | Radio equipment approval number   |
|--------------|----------------------|---|
| MARQUARDT    | MS2 (locking system) | 67372 / SDPPI/2020 7163<br><br>Dilarang melakukan perubahan spesifikasi yang dapat menimbulkan gangguan fisik dan/atau elektromagnetik terhadap lingkungan sekitarnya<br> |

| Manufacturer | Model designation                                      | Radio equipment approval number  |
|--------------|--|--|
| Schrader     | MC34MA4 (tire pressure monitoring system control unit) | 25626/SDPPI/2015 3612  |
| Visteon      | Connect 5 (head unit)                                  | 61671/SDPPI/2019 7163<br><br>Dilarang melakukan perubahan spesifikasi yang dapat menimbulkan gangguan fisik dan/atau elektromagnetik terhadap lingkungan sekitarnya<br> |

**Israel**
**Regulatory radio identification**

| Manufacturer | Model designation       | Radio equipment approval number                    |
|--------------|-------------------------|--|
|              |                         | Approval number of the Ministry of Communications: |
| Bosch        | LRR3 (radar sensor)     | 55-08334   |
| Bosch        | MRR1Rear (radar sensor) | 55-08333   |

| Manufacturer                        | Model designation  | Radio equipment approval number |
|-------------------------------------|--|---------------------------------|
| Bosch                               | MRRe14FCR (radar sensor)                                 | 55-08395                        |
| Bosch                               | FR5CPCCF (radar sensor)                                  | 55-08783                        |
| Bosch                               | F5CP12 (radar sensor)                                    | 55-12854                        |
| Continental Automotive              | MARS Keyless (locking system)                            | 55-13749                        |
| Continental Automotive Technologies | NTG7Q MID LF2 (head unit)                                | 51-90718                        |
| Continental Automotive Technologies | NTG7Q HIGH LF2 (head unit)                               | 51-90717                        |
| Continental Automotive Technologies | NTG7Q PRE-MIUM LF2 (head unit)                           | 51-90719                        |
| Harman Becker                       | NTG7 HIGH-IL (head unit)                                 | 51-89476                        |
| Harman Becker                       | NTG7 PRE-MIUMPLUS-IL (head unit)                         | 51-89475                        |
| HELLA                               | DM4 (Schließsystem)                                      | 55-14271                        |
| Huf Baolong                         | TSSRE4A (tire pressure sensor)                           | 63-66757                        |
| Huf Baolong                         | TSSRE4Uf (tire pressure sensor)                          | 63-66757                        |
| Huf Baolong                         | TSSSG4G6b (tire pressure monitoring system control unit) | 63-68102                        |
| MARQUARDT                           | DC12B (locking system)                                   | 55-12215                        |

| Manufacturer  | Model designation           | Radio equipment approval number |
|---------------|-----------------------------|---------------------------------|
| MARQUARDT     | MS2 (locking system)        | 51-85192                        |
| WITTE-Velbert | SDHTAG3NFC (locking system) | 55-12216                        |

### Jamaica

#### Regulatory radio identification

| Manufacturer           | Model designation  |
|------------------------|--|
| Continental Automotive | MARS Keyless (locking system)                            |
| HELLA                  | DM4 (locking system)                                     |
| Hirschmann             | 920510A (locking system)                                 |
| Huf Baolong            | TSSRE4A (tire pressure sensor)                           |
| Huf Baolong            | TSSRE4Uf (tire pressure sensor)                          |
| Huf Baolong            | TSSSG4G6b (tire pressure monitoring system control unit) |
| MARQUARDT              | DC12B (locking system)                                   |
| MARQUARDT              | MS2 (locking system)                                     |

### Japan

#### Regulatory radio identification

|  |                                |                                 |
|---|--------------------------------|---------------------------------|
| Manufacturer  | Model designation              | Radio equipment approval number |
| Continental Automotive Technologies   | NTG7Q HIGH LF2 (head unit)     | 003-230113                      |
| Continental Automotive Technologies   | NTG7Q PRE-MIUM LF2 (head unit) | 003-230112                      |

### Canada

#### Regulatory radio identification

| Manufacturer                        | Model designation               | Radio equipment approval number |
|-------------------------------------|---------------------------------|---------------------------------|
| ADC                                 | SRR6-A (control unit)           | IC: 4135A-SRR6A                 |
| Continental Automotive Technologies | NTG7Q MID LF2 (head unit)       | IC: NTG7QMIDLF2                 |
| Continental Automotive Technologies | NTG7Q HIGH LF2 (head unit)      | IC: NTG7QHIGLF2                 |
| Continental Automotive Technologies | NTG7Q PRE-MIUM LF2 (head unit)  | IC: NTG7QPREF2                  |
| Hirschmann                          | 920510A (locking system)        | IC:8653A-920510A                |
| Huf Baolong                         | TSSRE4A (tire pressure sensor)  | IC: 4008C-TSSRE4A               |
| Huf Baolong                         | TSSRE4Uf (tire pressure sensor) | IC: 3702A-TSSRE4UF              |

### Kuwait

#### Regulatory radio identification

| Manufacturer | Model designation  | Radio equipment approval number |
|--------------|--|---------------------------------|
| Huf Baolong  | TSSRE4A (tire pressure sensor)                           | 5420                            |
| Huf Baolong  | TSSRE4Uf (tire pressure sensor)                          | 3591                            |
| Huf Baolong  | TSSSG4G6b (tire pressure monitoring system control unit) | 3271                            |

**Malaysia**
**Regulatory radio identification**

|  |                                |                                 |
|---|--------------------------------|---------------------------------|
| Manufacturer  | Model designation              | Radio equipment approval number |
| Bosch   | FR5CPCCF (radar sensor)        | CIDF15000490                    |
| Bosch   | LRR3 (radar sensor)            | CIDF15000490                    |
| Bosch   | MRR1Rear (radar sensor)        | CIDF15000490                    |
| Bosch   | MRRe14FCR (radar sensor)       | CIDF15000490                    |
| Bosch   | MRRevo14F (radar sensor)       | CIDF15000490                    |
| Bosch   | F5CP12 (radar sensor)          | RGLN/30A/0522/S(22-2490)        |
| Continental Automotive  | MARS Keyless (locking system)  | CIDF15000578                    |
| Continental Automotive Technologies   | NTG7Q MID LF2 (head unit)      | RCCT/92G/0423/S(23-0350)        |
| Continental Automotive Technologies   | NTG7Q HIGH LF2 (head unit)     | CCT/91G/0323/S(23-1291)         |
| Continental Automotive Technologies   | NTG7Q PRE-MIUM LF2 (head unit) | RGQB/05A/0323/S(23-1293)        |
| HELLA   | DM4 (locking system)           | CIDF15000578                    |
| Hirschmann  | 920510A (locking system)       | RFFK/01A/1117/S(17-3581)        |
| Huf Baolong   | TSSRE4A (tire pressure sensor) | HIDF15000153                    |

|  |                                 |                                 |
|---|---------------------------------|---------------------------------|
| Manufacturer  | Model designation               | Radio equipment approval number |
| Huf Baolong   | TSSRE4Uf (tire pressure sensor) | HIDF15000153                    |
| MARQUARDT   | DC12B (locking system)          | RAUU/62A/0311/S(11-0263)        |
| MARQUARDT   | MS2 (locking system)            | RDDK/31A/0217/S(17-0405)        |

**Morocco**
**Regulatory radio identification**



| Manufacturer           | Model designation             | Radio equipment approval number |
|------------------------|-------------------------------|---------------------------------|
|                        |                               | AGREE PAR L'ANRT MAROC          |
| ADC                    | SRR6-A (control unit)         | MR 40021 ANRT 2023/09/19        |
| Bosch                  | FR5CPCCF (radar sensor)       | MR 20575 ANRT 2019-07-29        |
| Bosch                  | LRR3 (radar sensor)           | MR 5371 ANRT 2010 2019-12-05    |
| Bosch                  | MRR1Rear (radar sensor)       | MR 9186 ANTR 2014-04-22         |
| Bosch                  | MRRe14FCR (radar sensor)      | MR 13900 ANTR 2017-05-04        |
| Bosch                  | F5CP12 (radar sensor)         | MR00032137 ANRT2022             |
| Continental Automotive | MARS Keyless (locking system) | MR 13681 ANTR 2017-04-04        |



| Manufacturer | Model designation               | Radio equipment approval number   |
|--------------|---------------------------------|---|
| HELLA        | DM4 (locking system)            | MR 14426 ANTR<br>2017-07-28   |
| MARQUARDT    | DC12B (locking system)          | MR 6698 ANTR<br>2021-11-04  |
| Hirschmann   | 920510A (locking system)        | MR 14779 ANTR<br>2017-09-25   |
| Huf Baolong  | TSSRE4A (tire pressure sensor)  | AGREE PAR L'ANRT MAROC<br>MR 14320 ANRT 2017<br>Date d'agreement:<br>07/07/2017 |
| Huf Baolong  | TSSRE4Uf (tire pressure sensor) | AGREE PAR L'ANRT MAROC<br>MR 20944 ANRT 2019<br>Date d'agreement:<br>07/07/2017 |
| MARQUARDT    | DC12B (locking system)          | AGREE PAR L'ANRT MAROC<br>MR 6698 ANTR 2021<br>Date d'agreement:<br>04/11/2021  |

| Manufacturer | Model designation                                      | Radio equipment approval number   |
|--------------|--|---|
| MARQUARDT    | MS2 (locking system)                                   | MR 13300 ANTR<br>2017-02-15   |
| Schrader     | MC34MA4 (tire pressure monitoring system control unit) | AGREE PAR L'ANRT MAROC<br>MR 6706 ANTR<br>Date d'agreement:<br>2011-11-17 |

### Mexico

#### Regulatory radio identification

|    |                                |                                 |
|---|--------------------------------|---------------------------------|
| Manufacturer  | Model designation              | Radio equipment approval number |
| Bosch   | LRR3 (radar sensor)            | IFETEL: RCPBOLR09-0828          |
| Bosch   | MRR1Rear (radar sensor)        | IFETEL: RCPBOMR14-0922          |
| Bosch   | MRRre14FCR (radar sensor)      | IFETEL: RCPBOMR17-0598          |
| Continental Automotive  | MARS Keyless (locking system)  | IFETEL: RLVDAMA18-1827          |
| Continental Automotive Technologies   | NTG7Q MID LF2 (head unit)      | IFETEL: MEMENT23 - 12200        |
| Continental Automotive Technologies   | NTG7Q HIGH LF2 (head unit)     | IFETEL: MEMENT23 - 11923        |
| Continental Automotive Technologies   | NTG7Q PRE-MIUM LF2 (head unit) | IFETEL: MEMENT23 - 12204        |

|    |  |                                 |
|---|--|---------------------------------|
| Manufacturer  | Model designation                                      | Radio equipment approval number |
| HELLA   | DM4 (locking system)                                   | IFETEL: RLVHEDM17-10            |
| Hirschmann  | 920510A (locking system)                               | IFETEL: RLVHI9217-1754          |
| Huf Baolong   | TSSRE4A (tire pressure sensor)                         | IFETEL: RLVBHTS19-1995          |
| MARQUARDT   | DC12B (locking system)                                 | IFETEL: RLVMA DC11-0446         |
| MARQUARDT   | MS2 (locking system)                                   | IFETEL: RLVMA MS17-0222         |
| Schrader  | MC34MA4 (tire pressure monitoring system control unit) | IFETEL: RCPSCMR14-062           |

### Mongolia

#### Regulatory radio identification

|  |                                |                                 |
|---|--------------------------------|---------------------------------|
| Manufacturer  | Model designation              | Radio equipment approval number |
| Continental Automotive  | MARS Keyless (locking system)  | A18000328                       |
| HELLA   | DM4 (locking system)           | A18000329                       |
| Huf Baolong   | TSSRE4A (tire pressure sensor) | A19000569                       |

|  |  |                                 |
|---|--|---------------------------------|
| Manufacturer  | Model designation  | Radio equipment approval number |
| Huf Baolong   | TSSSG4G6b (tire pressure monitoring system control unit) | A21000451                       |
| MARQUARDT   | DC12B (locking system)                                   | A19000371                       |
| MARQUARDT   | MS2 (locking system)                                     | A18000289                       |

### Niger

#### Regulatory radio identification

| Manufacturer           | Model designation             | Radio equipment approval number |
|------------------------|-------------------------------|---------------------------------|
| Continental Automotive | MARS Keyless (locking system) | 083/ARCEP/DG/19                 |
| HELLA                  | DM4 (locking system)          | 082/ARCEP/DG/19                 |
| MARQUARDT              | DC12B (locking system)        | 008/ARCEP/DG/19                 |
| MARQUARDT              | MS2 (locking system)          | 014/ARCEP/DG/19                 |

### Nigeria

#### Regulatory radio identification

| Manufacturer | Model designation       |
|--------------|-------------------------|
| ADC          | SRR6-A (control unit)   |
| Bosch        | FR5CPCCF (radar sensor) |
| Bosch        | MRR1Rear (radar sensor) |

| Manufacturer           | Model designation  |
|------------------------|--|
| Bosch                  | MRRe14FCR (radar sensor)                                 |
| Bosch                  | F5CP12 (radar sensor)                                    |
| Continental Automotive | MARS Keyless (locking system)                            |
| HELLA                  | DM4 (locking system)                                     |
| Hirschmann             | 920510A (locking system)                                 |
| Huf Baolong            | TSSRE4Uf (tire pressure sensor)                          |
| Huf Baolong            | TSSSG4G6b (tire pressure monitoring system control unit) |
| MARQUARDT              | DC12B (locking system)                                   |
| MARQUARDT              | MS2 (locking system)                                     |

## Oman

### Regulatory radio identification

| Manufacturer           | Model designation             | Radio equipment approval number |
|------------------------|-------------------------------|---------------------------------|
| ADC                    | SRR6-A (control unit)         | TRA/TA-R/16591/23               |
| Bosch                  | FR5CPCCF (radar sensor)       | TRA/TA-R/7983/19<br>D172338     |
| Bosch                  | LRR3 (radar sensor)           | TRA/TA-R/1049/09                |
| Bosch                  | MRR1Rear (radar sensor)       | TRA/TA-R/1849/14                |
| Bosch                  | MRRe14FCR (radar sensor)      | TRA/TA-R/4353/17                |
| Bosch                  | F5CP12 (radar sensor)         | TRA/TA-R/13339/22               |
| Continental Automotive | MARS Keyless (locking system) | TRA/TA-R/4158/17<br>D080134     |

| Manufacturer | Model designation               | Radio equipment approval number |
|--------------|---------------------------------|---------------------------------|
| HELLA        | DM4 (locking system)            | TRA/TA-R/4548/17<br>D080134     |
| Hirschmann   | 920510A (locking system)        | TRA/TA-R/4748/17<br>D080134     |
| Huf Baolong  | TSSRE4Uf (tire pressure sensor) | TRA/TA-R/8240/19                |
| MARQUARDT    | DC12B (locking system)          | TRA/TA-R/0227/11<br>D080353     |

## Pakistan

### Regulatory radio identification













| Manufacturer           | Model designation               | Radio equipment approval number |
|------------------------|---------------------------------|---------------------------------|
| Bosch                  | FR5CPCCF (radar sensor)         | TAC NO: 9.198/2020              |
| Bosch                  | F5CP12 (radar sensor)           | TAC NO: 9.243/2023              |
| Continental Automotive | MARS Keyless (locking system)   | TAC NO: 9.213/2017              |
| HELLA                  | DM4 (locking system)            | TAC NO: 9.409/2017              |
| Hirschmann             | 920510A (locking system)        | TAC NO: 9.287/2020              |
| Huf Baolong            | TSSRE4A (tire pressure sensor)  | TAC NO: 9.620/2017              |
| Huf Baolong            | TSSRE4Uf (tire pressure sensor) | TAC NO: 9.9903/2019             |



|  |  |                                 |
|---|--|---------------------------------|
| Manufacturer  | Model designation  | Radio equipment approval number |
| Huf Baolong   | TSSSG4G6b (tire pressure monitoring system control unit) | TAC NO: 9.9345/2019             |
| MARQUARDT   | DC12B (locking system)                                   | TAC NO: 9.829/2013              |
| MARQUARDT   | MS2 (locking system)                                     | TRA/TA-R/4136/17<br>D080134     |

#### Paraguay

##### Regulatory radio identification

|  |                          |  |
|---|--------------------------|--|
| Manufacturer  | Model designation        | Radio equipment approval number  |
| ADC   | SRR6-A (control unit)    | <br>2023-11-I-0817    |
| Bosch   | FR5CPCCF (radar sensor)  | <br>2019-09-I-0508    |
| Bosch   | MRRe14FCR (radar sensor) | <br>2017-06-I-0000162 |

|  |                                |  |
|---|--------------------------------|--|
| Manufacturer  | Model designation              | Radio equipment approval number  |
| Bosch   | MRR1Rear (radar sensor)        | <br>2019-05-I-000236                       |
| Bosch   | F5CP12 (radar sensor)          | <br>2019-05-I-000236                       |
| Continental Automotive  | MARS Keyless (locking system)  | <br>2017-05-I-0000136 y                    |
| HELLA   | DM4 (locking system)           | <br>2022-06-I-0388 y<br>2017-08-I-0000261 |
| Hirschmann  | 920510A (locking system)       | <br>2023-01-I-0058                       |
| Huf Baolong   | TSSRE4A (tire pressure sensor) | <br>2022-08-I-0528                       |

|  |                        |   |
|---|------------------------|---|
| Manufacturer  | Model designation      | Radio equipment approval number   |
| MARQUARDT   | DC12B (locking system) | <br>2021-05-I-0304;<br>2016-5-I-000144 y<br>2011-06-I-0067 |
| MARQUARDT   | MS2 (locking system)   | TRA/TA-R/4136/17<br>D080134   |

### Philippines

#### Regulatory radio identification

|  |                               |                                 |
|--|-------------------------------|---------------------------------|
| Manufacturer   | Model designation             | Radio equipment approval number |
| Bosch  | FR5CPCCF (radar sensor)       | ESD-1920531 C                   |
| Bosch  | MRR1Rear (radar sensor)       | ESD-1408917 C                   |
| Bosch  | MRRre14FCR (radar sensor)     | ESD-1716172 C                   |
| Bosch  | F5CP12 (radar sensor)         | ESD-RCE-2229495                 |
| Continental Automotive   | MARS Keyless (locking system) | ESD-1714865 C                   |
| HELLA  | DM4 (locking system)          | ESD-1715539 C                   |

|  |                                 |                                 |
|---|---------------------------------|---------------------------------|
| Manufacturer  | Model designation               | Radio equipment approval number |
| Hirschmann  | 920510A (locking system)        | ESD-1715811 C                   |
| Huf Baolong   | TSSRE4A (tire pressure sensor)  | ESD-1715393 C                   |
| Huf Baolong   | TSSRE4Uf (tire pressure sensor) | ESD-1920803 C                   |
| MARQUARDT   | DC12B (locking system)          | ESD-1105216 C                   |
| MARQUARDT   | MS2 (locking system)            | ESD-1715652 C                   |

### Zambia

#### Regulatory radio identification

|  |                               |                                 |
|--|-------------------------------|---------------------------------|
| Manufacturer   | Model designation             | Radio equipment approval number |
| ADC  | SRR6-A (control unit)         | ZMB/ZICTA/TA2023/11/37          |
| Continental Automotive   | MARS Keyless (locking system) | ZMB/ZICTA/TA/2019/3/3           |
| HELLA  | DM4 (locking system)          | ZMB/ZICTA/TA/2019/3/4           |
| MARQUARDT  | DC12B (locking system)        | ZMB/ZICTA/TA/2019/5/17          |
| MARQUARDT  | MS2 (locking system)          | ZMB/ZICTA/TA/2018/9/30          |

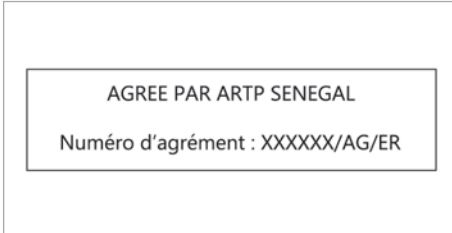
**Senegal**

**Regulatory radio identification**

| Manufacturer | Model designation     | Radio equipment approval number |
|--------------|-----------------------|---------------------------------|
| ADC          | SRR6-A (control unit) | 072710/AG/ER                    |

**Serbia**
**Regulatory radio identification**

| Manufacturer                        | Model designation             | Radio equipment approval number |
|-------------------------------------|-------------------------------|---------------------------------|
| ADC                                 | SRR6-A (control unit)         | I038 23                         |
| Bosch                               | FR5CPCCF (radar sensor)       | I011 19                         |
| Bosch                               | LRR3 (radar sensor)           | I011 19                         |
| Bosch                               | MRR1Rear (radar sensor)       | I011 17                         |
| Bosch                               | MRRre14FCR (radar sensor)     | I005 17                         |
| Continental Automotive              | MARS Keyless (locking system) | I005 20                         |
| Continental Automotive Technologies | NTG7Q MID LF2 (head unit)     | I005 23                         |



| Manufacturer                        | Model designation  | Radio equipment approval number |
|-------------------------------------|--|---------------------------------|
| Continental Automotive Technologies | NTG7Q HIGH LF2 (head unit)                               | I005 23                         |
| Continental Automotive Technologies | NTG7Q PRE-MIUM LF2 (head unit)                           | I005 23                         |
| HELLA                               | DM4 (locking system)                                     | I005 20                         |
| Hirschmann                          | 920510A (locking system)                                 | I005 20                         |
| Huf Baolong                         | TSSRE4A (tire pressure sensor)                           | I005 23                         |
| Huf Baolong                         | TSSRE4Uf (tire pressure sensor)                          | I005 22                         |
| Huf Baolong                         | TSSSG4G6b (tire pressure monitoring system control unit) | I005 22                         |
| MARQUARDT                           | DC12B (locking system)                                   | I005 20                         |
| MARQUARDT                           | MS2 (locking system)                                     | I011 17                         |

**Singapore**
**Regulatory radio identification**

| Manufacturer    | Model designation     | Radio equipment approval number |
|-----------------|-----------------------|---------------------------------|
|                 |                       | Complies with IMDA Standards    |
| Continental ADC | SRR6-A (control unit) | DB107091                        |

| Manufacturer                        | Model designation  | Radio equipment approval number |
|-------------------------------------|--|---------------------------------|
| Bosch                               | FR5CPCCF (radar sensor)                                  | DA105282                        |
| Bosch                               | LRR3 (radar sensor)                                      | DB101762                        |
| Bosch                               | MRR1Rear (radar sensor)                                  | DA105282                        |
| Bosch                               | MRRevo14F (radar sensor)                                 | DA103365                        |
| Bosch                               | MRRre14FCR (radar sensor)                                | DB03227                         |
| Bosch                               | F5CP12 (radar sensor)                                    | N3827-22                        |
| Continental Automotive              | MARS Keyless (locking system)                            | DA105282                        |
| Continental Automotive Technologies | NTG7Q MID LF2 (head unit)                                | DA105282                        |
| Continental Automotive Technologies | NTG7Q HIGH LF2 (head unit)                               | DA105282                        |
| Continental Automotive Technologies | NTG7Q PRE-MIUM LF2 (head unit)                           | DA105282                        |
| HELLA                               | DM4 (locking system)                                     | DA103365<br>N3308-22            |
| Hirschmann                          | 920510A (locking system)                                 | N1412-18                        |
| Huf Baolong                         | TSSRE4A (tire pressure sensor)                           | DA105282                        |
| Huf Baolong                         | TSSRE4Uf (tire pressure sensor)                          | DA103365                        |
| Huf Baolong                         | TSSSG4G6b (tire pressure monitoring system control unit) | DA28467                         |

| Manufacturer  | Model designation             | Radio equipment approval number |
|---------------|-------------------------------|---------------------------------|
| MARQUARDT     | DC12B (locking system)        | DA103365                        |
| MARQUARDT     | MS2 (locking system)          | DA103787                        |
| Meta System   | ITS/TPS (interior protection) | DA103365                        |
| Meta System   | MUW II (interior protection)  | DA103365                        |
| Veoneer       | 6208428 (radar sensor)        | N2743-16                        |
| Veoneer       | 24 GHz MMR (radar sensor)     | N2955-17                        |
| WITTE-Velbert | SDHTAG3NFC (locking system)   | DA107248<br>N1755-20            |

#### South Africa

##### Regulatory radio identification

|  |                           |                                 |
|--|---------------------------|---------------------------------|
| Manufacturer   | Model designation         | Radio equipment approval number |
| Continental ADC  | SRR6-A (control unit)     | TA-2023/1985                    |
| Bosch  | FR5CPCCF (radar sensor)   | TA-2019/1200                    |
| Bosch  | MRR1Rear (radar sensor)   | TA-2014/212                     |
| Bosch  | MRRre14FCR (radar sensor) | TA-2017/2013                    |
| Bosch  | LRR3 (radar sensor)       | TA-2009/464                     |
| Bosch  | F5CP12 (radar sensor)     | TA-2022/0153                    |

|  |  |                                 |
|---|--|---------------------------------|
| Manufacturer  | Model designation  | Radio equipment approval number |
| Continental Automotive  | MARS Keyless (locking system)                            | TA-2016/3500                    |
| Continental Automotive Technologies   | NTG7Q MID LF2 (head unit)                                | TA-2023/0091                    |
| Continental Automotive Technologies   | NTG7Q HIGH LF2 (head unit)                               | TA-2023/0111                    |
| Continental Automotive Technologies   | NTG7Q PRE-MIUM LF2 (head unit)                           | TA-2023/0090                    |
| HELLA   | DM4 (locking system)                                     | TA-2017/2518                    |
| Hirschmann  | 920510A (locking system)                                 | TA-2017/2350                    |
| Huf Baolong   | TSSRE4A (tire pressure sensor)                           | TA-2017/1393                    |
| Huf Baolong   | TSSRE4Uf (tire pressure sensor)                          | TA-2019/1853                    |
| Huf Baolong   | TSSSG4G6b (tire pressure monitoring system control unit) | TA-2019/1440                    |
| MARQUARDT   | DC12B (locking system)                                   | TA-2011/370                     |
| MARQUARDT   | MS2 (locking system)                                     | TA-2016/3314                    |
| Schrader  | MC34MA4 (tire pressure monitoring system control unit)   | TA-2011/1370                    |

## South Korea

### Regulatory radio identification

|  |                                  |                                 |
|---|----------------------------------|---------------------------------|
| Manufacturer  | Model designation                | Radio equipment approval number |
| Continental Automotive Technologies   | NTG7Q LF2 (head unit)            | R-R-TeH-NTG7QLF2                |
| Hirschmann  | 920510A (locking system)         | R-C-0HR-920510A                 |
| Huf Baolong   | TSSRE4A (tire pressure sensor)   | R-CRM-HHFTSSRE4A                |
| Huf Baolong   | TSSRE4Uf (tire pressure sensor)  | R-CRM-HHF-TSSRE4A               |
| Huf Baolong   | TSSSG4G6b (tire pressure sensor) | R-R-HEB-TSSSG4G6B               |

## Taiwan

### Regulatory radio identification

|  |                                |                                 |
|---|--------------------------------|---------------------------------|
| Manufacturer  | Model designation              | Radio equipment approval number |
| Continental Automotive Technologies   | NTG7Q MID LF2 (head unit)      | CCAH23LP2940T1                  |
| Continental Automotive Technologies   | NTG7Q HIGH LF2 (head unit)     | CCAH23LP2960T4                  |
| Continental Automotive Technologies   | NTG7Q PRE-MIUM LF2 (head unit) | CCAH23LP2980T0                  |



| Manufacturer | Model designation               | Radio equipment approval number |
|--------------|---------------------------------|---------------------------------|
| Hirschmann   | 920510A (locking system)        | CCAB18LP21 80T1                 |
| Huf Baolong  | TSSRE4A (tire pressure sensor)  | CCAO17LP03 80T4                 |
| Huf Baolong  | TSSRE4Uf (tire pressure sensor) | CCAH19LP71 10T8                 |

#### Thailand

##### Regulatory radio identification

| Manufacturer                        | Model designation              | Radio equipment approval number  |
|-------------------------------------|--------------------------------|--|
| Continental Automotive Technologies | NTG7Q PRE-MIUM LF2 (head unit) | 130111-23-0132<br> |

#### Togo

##### Regulatory radio identification

| Manufacturer           | Model designation             | Radio equipment approval number |
|------------------------|-------------------------------|---------------------------------|
| Continental Automotive | MARS Keyless (locking system) | No. 040/19                      |
| HELLA                  | DM4 (locking system)          | No. 039/19                      |
| MARQUARDT              | DC12B (locking system)        | No. 057/19                      |
| MARQUARDT              | MS2 (locking system)          | No. 008/19                      |

#### Ukraine

##### Regulatory radio identification



| Manufacturer                        | Model designation  | Radio equipment approval number |
|-------------------------------------|--|---------------------------------|
| Continental Automotive              | MARS Keyless (locking system)                            | RTS.UKR.355-34/18               |
| Continental Automotive Technologies | NTG7Q MID LF2 (head unit)                                | UA.TR.052                       |
| Continental Automotive Technologies | NTG7Q HIGH LF2 (head unit)                               | UA.TR.052                       |
| Continental Automotive Technologies | NTG7Q PRE-MIUM LF2 (head unit)                           | UA.TR.052                       |
| HELLA                               | DM4 (locking system)                                     | UA.TR.109                       |
| Hirschmann                          | 920510A (locking system)                                 | UKR.355-9/20                    |
| Hirschmann                          | 920508A (locking system)                                 | Supplier number: 16833352       |
| Hirschmann                          | 920508B (locking system)                                 | Supplier number: 16833352       |
| Huf Baolong                         | TSSRE4A (tire pressure sensor)                           | UA 1.001.01856 8-19-TE          |
| Huf Baolong                         | TSSRE4Uf (tire pressure sensor)                          | UA 1.001.02070 2-19-TE          |
| Huf Baolong                         | TSSSG4G6b (tire pressure monitoring system control unit) | UA 1.001.01928 9-19-TE          |



| Manufacturer | Model designation      | Radio equipment approval number |
|--------------|------------------------|---------------------------------|
| MARQUARDT    | DC12B (locking system) | UA.R.TR.052.308-19              |
| MARQUARDT    | MS2 (locking system)   | UA1.001.019 129-19-TE           |

### Uzbekistan

#### Regulatory radio identification







| Manufacturer           | Model designation             |
|------------------------|-------------------------------|
| Continental Automotive | MARS Keyless (locking system) |
| HELLA                  | DM4 (locking system)          |
| MARQUARDT              | DC12B (locking system)        |
| MARQUARDT              | MS2 (locking system)          |

### United Arab Emirates



#### Regulatory radio identification

| Manufacturer                        | Model designation             | Radio equipment approval number   |
|-------------------------------------|-------------------------------|---|
| Bosch                               | FR5CPCCF (radar sensor)       | TA RTTE: ER74533/19, DA36758/14<br> |
| Continental Automotive              | MARS Keyless (locking system) | TRA ER56005/17, DA44932/15  |
| Continental Automotive Technologies | NTG7Q MID LF2 (head unit)     | TDRA ER17731/23, DA76163/18<br>     |
| Continental Automotive Technologies | NTG7Q HIGH LF2 (head unit)    | TDRA ER17730/23, DA76163/18<br>    |
| Continental Automotive Technologies | NTG7Q PREMIUM LF2 (head unit) | TDRA ER17732/23, DA76163/18<br>   |
| HELLA                               | DM4 (locking system)          | TRA ER56616/17, DA44932/15  |
| Hirschmann                          | 920510A (locking system)      | TRA ER59686/17  |

| Manufacturer | Model designation  | Radio equipment approval number |
|--------------|--|---------------------------------|
| Huf Baolong  | TSSRE4A (tire pressure sensor)                           | TRA ER57806/17 DA36976/14       |
| Huf Baolong  | TSSRE4Uf (tire pressure sensor)                          | TRA ER75266/19                  |
| Huf Baolong  | TSSSG4G6b (tire pressure monitoring system control unit) | TRA ER7307/19 DA0086237/12      |
| MARQUARDT    | DC12B (locking system)                                   | TRA ER0067828/11 DA0018994/09   |
| MARQUARDT    | MS2 (locking system)                                     | TRA ER52668/17, DA0018994/09    |

### United Kingdom

#### Regulatory radio identification

|  |                               |
|---|-------------------------------|
| Manufacturer  | Model designation             |
| ADC   | SRR6-A (control unit)         |
| Continental Automotive  | MARS Keyless (locking system) |
| Continental Automotive Technologies   | NTG7Q MID LF2 (head unit)     |
| Continental Automotive Technologies   | NTG7Q HIGH LF2 (head unit)    |
| Continental Automotive Technologies   | NTG7Q PREMIUM LF2 (head unit) |
| Hirschmann  | 920510A (locking system)      |
| HELLA   | DM4 (locking system)          |



| Manufacturer | Model designation  |
|--------------|--|
| Huf Baolong  | TSSRE4A (tire pressure sensor)                           |
| Huf Baolong  | TSSSG4G6b (tire pressure monitoring system control unit) |
| MARQUARDT    | DC12B (locking system)                                   |
| MARQUARDT    | MS2 (locking system)                                     |
| Schrader     | HSW4T (tire pressure sensor)                             |

### United States

#### Regulatory radio identification

| Manufacturer                        | Model designation              | Radio equipment approval number |
|-------------------------------------|--------------------------------|---------------------------------|
| ADC                                 | SRR6-A (control unit)          | FCC ID: OAYSRR6a                |
| Continental Automotive Technologies | NTG7Q MID LF2 (head unit)      | FCC ID: NTG7QMIDLF2             |
| Continental Automotive Technologies | NTG7Q HIGH LF2 (head unit)     | FCC ID: NTG7QHIGLF2             |
| Continental Automotive Technologies | NTG7Q PREMIUM LF2 (head unit)  | FCC ID: NTG7QPRELF2             |
| Hirschmann                          | 920510A (locking system)       | FCC ID: XTJ920510A              |
| Huf Baolong                         | TSSRE4A (tire pressure sensor) | FCC ID: YGOTSRE4A               |

| Manufacturer | Model designation                                    | Radio equipment approval number |
|--------------|--|---------------------------------|
| Huf Baolong  | TSSRE4Uf (tire pressure sensor)                      | FCC ID: OYGTSSRE4U F            |
| Schrader     | HSW4T (tire pressure monitoring system control unit) | FCC ID: MRXMC34MA 4             |

**Information on installation clearances**

**Charging unit for the wireless charging of mobile devices (WMI):**

This equipment complies with FCC and IC radiation exposure limits set forth for an uncontrolled environment. This equipment should be installed and operated with minimum distance of 0 cm (in contact) between the radiator and your body. This transmitter must not be co-located or operating in conjunction with any other antenna or transmitter. Cet équipement est conforme aux limites d'exposition aux rayonnements IC établies pour un Environnement non contrôlé. Cet équipement doit être installé et utilisé avec un minimum de 0 cm (in contact) de distance entre la source de rayonnement et votre corps. Ce transmetteur ne doit pas être placé au même endroit ou utilisé simultanément avec un autre transmetteur ou antenne.

**Radar sensors:**

ARS4-C (ADC), ARS4-B (ADC), ARS4-A (ADC), FR5CPCCF (Bosch), MRR1REAR (Bosch), MRREVO14F (Bosch), LRR3 (Bosch), 77V12BSM (Veoneer), 77V12CRN (Veoneer), MMRV1 (Veoneer)

**Radiofrequency radiation exposure Information:**

This equipment complies with FCC radiation exposure limits set forth for an uncontrolled environment. This equipment should be installed and operated with minimum distance of 20 cm between the radiator and your body.

This transmitter must not be co-located or operating in conjunction with any other antenna or transmitter.

This equipment should be installed and operated with minimum distance of 20 cm between the radiator and your body. Cet équipement doit être installé et utilisé avec un minimum de 20 cm de distance entre la source de rayonnement et votre corps.

**Vietnam**

**Regulatory radio identification**



| Manufacturer           | Model designation             | Radio equipment approval number                                |
|------------------------|-------------------------------|--|
| Bosch                  | FR5CPCCF (radar sensor)       | Mercedes-Benz Vietnam Company Limited                          |
| Bosch                  | MRR1Rear (radar sensor)       | Mercedes-Benz Vietnam Company Limited                          |
| Bosch                  | MRRe14FCR (radar sensor)      | Mercedes-Benz Vietnam Company Limited                          |
| Continental Automotive | MARS Keyless (locking system) | Mercedes-Benz Vietnam Company Limited<br>B074824041<br>9AF04A2 |
| HELLA                  | DM4 (locking system)          | Mercedes-Benz Vietnam Company Limited<br>C020403032<br>1AF04A3 |
| Hirschmann             | 920510A (locking system)      | C051226112<br>0AF04A3  |
| Hirschmann             | 920510A (locking system)      | C029018121<br>8AF04A2<br>Supplier number:<br>16833352          |

| Manufacturer | Model designation      | Radio equipment approval number                                     |
|--------------|------------------------|---|
| MARQUARDT    | DC12B (locking system) | Suntech Vietnam Technology Company Limited<br>C007621012<br>1AF04A3 |
| MARQUARDT    | MS2 (locking system)   | Suntech Vietnam Technology Company Limited<br>C007521012<br>1AF04A3 |

### Information about the specific absorption rate (SAR)

#### Information on the specific absorption rate

The values have been determined and tested in accordance with Décret n° 2019-1186 regarding the indication of the specific absorption rate of radio-based vehicle components.

Further information and updates are available at the following web address:

<https://regulatoryradioinformation.corpinter.net/vans/us>



#### Information on the specific absorption rate

| Vehicle components                       | SAR value in W/kg | Limit value to be used |
|--|-------------------|------------------------|
| ECE DE003 & ECE DE004 compensator        | < 0.2 W/kg        | 2 W/kg                 |
| DAI RSE                                  | 1.8 W/kg          | 2 W/kg                 |
| D-WMI2020A                               | 0.018 W/kg        | 4 W/kg                 |
| HERMES communication module              | < 0.4 W/kg        | 2 W/kg                 |
| RAMSES communication module              | 0.036 W/kg        | 2 W/kg                 |
| NRCS2P                                   | 0.003 W/kg        | 2 W/kg                 |
| NTG6                                     | 0.199 W/kg        | 4 W/kg                 |
| NTG7                                     | 0.08 W/kg         | 2 W/kg                 |
| NTG7RSU                                  | 0.07 W/kg         | 2 W/kg                 |
| SM-T230NZ tablet PC                      | 0.7 W/kg          | 4 W/kg                 |
| Radio data transmission telephone system | 0.24 W/kg         | 2 W/kg                 |

Vehicle identification plate, vehicle identification number (VIN) and engine number

Vehicle identification plate

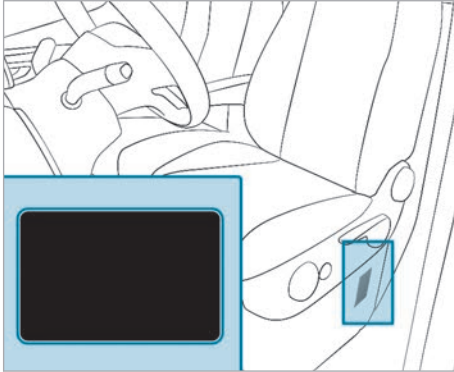

Vehicle identification plate (example: USA)

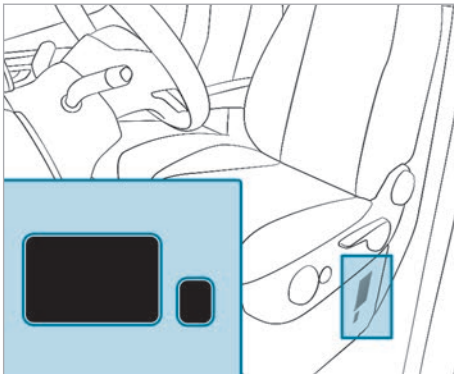

Vehicle identification plate (example: Canada)

Depending on the vehicle model, the vehicle identification plate is located on the seat box of the driver's seat or on the B-pillar.

- i** The data is vehicle-specific and may differ from that shown. Always observe the specifications on your vehicle identification plate.

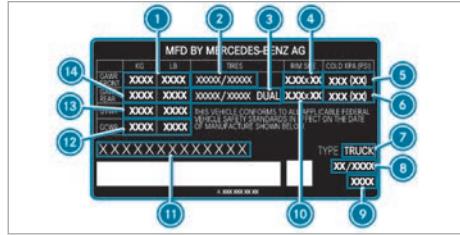

Vehicle identification plate (example: USA, complete vehicles)

- 1 Maximum permissible axle load, front
- 2 Tire size, front
- 3 Tire size, rear
- 4 Wheel size, front
- 5 Recommended tire pressure, front (with cold tires)
- 6 Recommended tire pressure, rear (with cold tires)
- 7 Vehicle model
- 8 Manufacturing date
- 9 Paint code
- 10 Wheel size, rear
- 11 VIN (vehicle identification number)
- 12 Permissible gross mass of vehicle combination
- 13 Permissible gross mass
- 14 Permissible axle load, rear

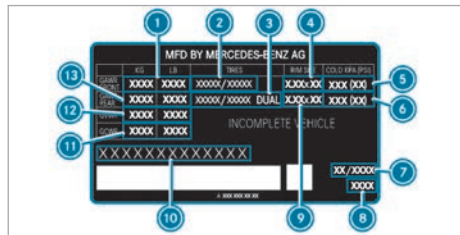

Vehicle identification plate (example: USA, incomplete vehicles)

- 1 Maximum permissible axle load, front
- 2 Tire size, front
- 3 Tire size, rear
- 4 Wheel size, front
- 5 Recommended tire pressure, front (with cold tires)
- 6 Recommended tire pressure, rear (with cold tires)
- 7 Manufacturing date
- 8 Paint code

- ⑨ Wheel size, rear
- ⑩ VIN (vehicle identification number)
- ⑪ Permissible gross mass of vehicle combination
- ⑫ Permissible gross mass
- ⑬ Permissible axle load, rear

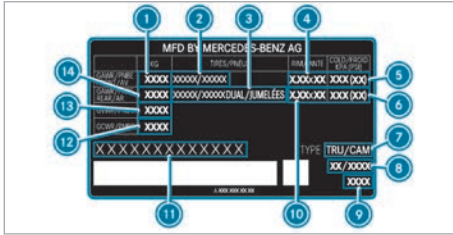

Vehicle identification plate (example: Canada, complete vehicles)

- ① Maximum permissible axle load, front
- ② Tire size, front
- ③ Tire size, rear
- ④ Wheel size, front
- ⑤ Recommended tire pressure, front (with cold tires)
- ⑥ Recommended tire pressure, rear (with cold tires)
- ⑦ Vehicle model
- ⑧ Manufacturing date
- ⑨ Paint code
- ⑩ Wheel size, rear
- ⑪ VIN (vehicle identification number)
- ⑫ Permissible gross mass of vehicle combination
- ⑬ Permissible gross mass
- ⑭ Permissible axle load, rear

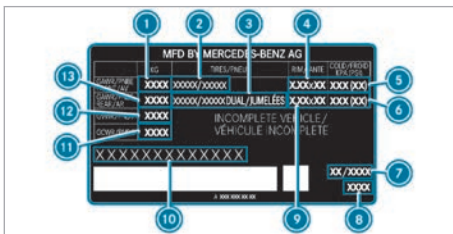

Vehicle identification plate (example: Canada, incomplete vehicles)

- ① Maximum permissible axle load, front
- ② Tire size, front
- ③ Tire size, rear
- ④ Wheel size, front

- ⑤ Recommended tire pressure, front (with cold tires)
- ⑥ Recommended tire pressure, rear (with cold tires)
- ⑦ Manufacturing date
- ⑧ Paint code
- ⑨ Wheel size, rear
- ⑩ VIN (vehicle identification number)
- ⑪ Permissible gross mass of vehicle combination
- ⑫ Permissible gross mass
- ⑬ Permissible axle load, rear

The gross vehicle weight rating comprises the vehicle weight, all vehicle occupants, the fuel and the load. The maximum gross axle weight rating is the maximum weight that can be carried by one axle (front or rear axle).

Do not exceed the gross vehicle weight rating or the maximum gross axle weight rating of the front or rear axle.

The vehicle identification plate may also include the following data:

- Payload
- Curb weight
- Number of passenger seats

**Canada only:** The following plate (plate used is dependent on the state of completion of the body) is located next to the vehicle identification plate.

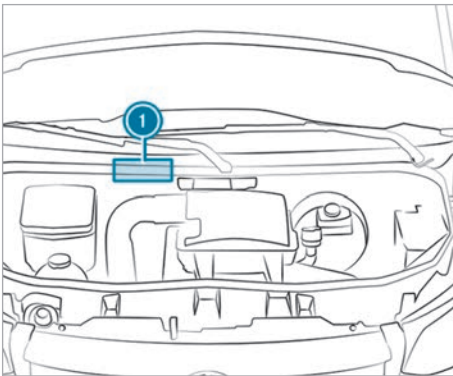

Plate confirming national emissions gas guideline values and safety requirements for motor vehicles (example: Canada, complete vehicles)



Plate confirming national emissions gas guideline values (example: Canada, incomplete vehicles)

**VIN engraved underneath the hood**



Engraved VIN ① is located underneath the hood.

**VIN on lower section of windshield**

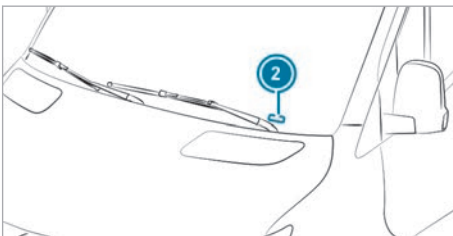

The VIN is also attached as a label on the lower section of the windshield ②.

**Emission Control Information label**

| MERCEDES-BENZ AG<br>VEHICLE EMISSION CONTROL INFORMATION |                         |
|--|-------------------------|
| Conforms to regulations: <b>XXXX MY</b>                  | Fuel: <b>Electric</b>   |
| U.S. EPA Class/ stds.: <b>XXX</b>                        | OBD: <b>n/a</b>         |
| California Class/ stds.: <b>XXX</b>                      | OBD: <b>n/a</b>         |
| <b>No adjustments needed.</b> n/a                        |                         |
| Group: <b>XXX</b>  | EVAP: <b>n/a</b>        |
| Remarks: <b>n/a</b>                                      | A XXX XXX XX XX 1234567 |

Example: Emission Control Information label

① The data is vehicle-specific and may differ from that shown.

**Electric motor number**

The engine number is attached to the bottom of the electric motor at the front. More detailed information can be obtained at a qualified specialist workshop.

**Operating fluids and capacities**

**Notes on operating fluids**

**⚠ WARNING** Risk of injury due to harmful operating fluids

Operating fluids can be toxic.

- ▶ When using, storing and disposing of operating fluids, observe the imprints on the respective original containers.
- ▶ Always keep operating fluids in the sealed original container.
- ▶ Always keep children away from operating fluids.

**🌿 ENVIRONMENTAL NOTE** Pollution of the environment due to irresponsible disposal of operating fluids

Incorrect disposal of operating fluids can cause considerable damage to the environment.

- ▶ Dispose of operating fluids in an environmentally responsible manner.

Operating fluids include the following:

- Lubricants
- Coolant
- Brake fluid

- Windshield washer fluid
- Climate control system refrigerant

Only use products which have been approved for your vehicle by Mercedes-Benz. Damage caused to the vehicle by using products that have not been approved is not covered by the Mercedes-Benz warranty or goodwill gestures.

You can identify operating fluids approved by Mercedes-Benz by the following labels on the container:

- MB-Freigabe (e.g. MB-Freigabe 325.5)
- MB-Approval (e.g. MB-Approval 325.5)

Further information on approved operating fluids is available from the following sources:

- In the MB Specifications for operating fluids at <https://operatingfluids.mercedes-benz.com> (with details of specification).
- At a qualified specialist workshop

Additives for approved operating fluids are neither required nor permitted. Additives can cause engine damage and must therefore not be added to the operating fluids.

### Notes on brake fluid

Observe the notes on operating fluids (→ page 243).

**⚠ WARNING** Risk of an accident due to vapor pockets forming in the brake system

The brake fluid constantly absorbs moisture from the air. This lowers the boiling point of the brake fluid. If the boiling point is too low, vapor pockets may form in the brake system when the brakes are applied hard.

This causes the braking effect to be impaired.

- ▶ Have the brake fluid renewed at the specified intervals.

Have the brake fluid replaced every two years at a qualified specialist workshop.

**! NOTE** Damage to paint, plastic or rubber by brake fluid

There is a risk of damage to property if brake fluid comes into contact with paint, plastic or rubber.

- ▶ If paint, plastic or rubber comes into contact with brake fluid, rinse with water immediately.

Observe the notes on paintwork/matte paintwork care (→ page 173).

Only use brake fluid approved by Mercedes-Benz in accordance with MB-Freigabe or MB-Approval 331.0.

Information on brake fluid is available at the following locations:

- In the MB Specifications for operating fluids 331.0 at <https://operatingfluids.mercedes-benz.com>
- At a qualified specialist workshop

### Coolant

#### Notes on coolant

Observe the notes on operating fluids (→ page 243).

**⚠ WARNING** Risk of fire- and injury from antifreeze

If antifreeze comes into contact with hot component parts in the engine compartment, it may ignite.

- ▶ Allow the drive system to cool down before you add antifreeze.
- ▶ Make sure that no antifreeze spills out next to the filler opening.
- ▶ Thoroughly clean the antifreeze from component parts before starting the vehicle.

**! NOTE** Damage caused by incorrect coolant

- ▶ Only add coolant that has been premixed with the required antifreeze protection.

Information on coolant is available at the following locations:

- In the MB Specifications for operating fluids 320.1 at <https://operatingfluids.mercedes-benz.com>
- At a qualified specialist workshop

**!** **NOTE** Overheating at high outside temperatures

If an inappropriate coolant is used, the engine cooling system is not sufficiently protected against overheating and corrosion at high outside temperatures.

- ▶ Always use coolant approved for Mercedes-Benz.
- ▶ Observe the instructions in the MB Specifications for operating fluids 320.1.

**!** **NOTE** Paintwork damage due to coolant

- ▶ Do not spill coolant on painted surfaces.

Have the coolant replaced regularly at a qualified specialist workshop.

Note the proportion of anti-corrosion/antifreeze agent in the engine cooling system within the following temperature ranges:

- A minimum of 50 % (antifreeze protection down to about -35°F (-37°C))
- A maximum of 55 % (antifreeze protection down to -49°F (-45°C))

**■ Coolant capacity**

The capacity may vary depending on the engine type and equipment.

**Coolant**

| Model                                      | Capacity                     |
|--|------------------------------|
| Vehicles with 56 kWh high-voltage battery  | around 5.6 gal (21.1 liters) |
| Vehicles with 81 kWh high-voltage battery  | around 5.2 gal (19.6 liters) |
| Vehicles with 113 kWh high-voltage battery | around 4.9 gal (18.5 liters) |

**Windshield washer fluid**

**■ Notes on windshield washer fluid**

Observe the notes on operating fluids (→ page 243).

**⚠ WARNING** Risk of fire and injury from windshield washer concentrate

Windshield washer concentrate is highly flammable. If it comes into contact with hot components, it may ignite.

- ▶ Make sure that windshield washer concentrate is not spilled near to the filler opening.

**!** **NOTE** Damage to the exterior lighting due to unsuitable windshield washer fluid

Unsuitable windshield washer fluid may damage the plastic surface of the exterior lighting.

- ▶ Only use windshield washer fluid which is also suitable for use on plastic surfaces, e.g. MB SummerFit or MB WinterFit.

**!** **NOTE** Blocked spray nozzles caused by mixing windshield washer fluids

- ▶ Do not mix MB SummerFit and MB WinterFit with other windshield washer fluids.

Do not use distilled or de-ionized water. Otherwise, the fill level sensor may give a false reading.

**■ Information on the windshield washer fluid**

Recommended windshield washer fluid:

- Above freezing point: e.g. MB SummerFit
- Below freezing point: e.g. MB WinterFit

**Mixing ratio**

For the correct mixing ratio, refer to the information on the anti-freeze container.

Mix the washer fluid with windshield washer fluid all year round.

**Filling quantities**

**Windshield washer system**

|              |                |
|--------------|----------------|
| Washer fluid | 5.8 qt (5.5 l) |
|--------------|----------------|

**Refrigerant**

**■ Notes on refrigerant**

Observe the notes on operating fluids (→ page 243).

- ⓘ Your vehicle's climate control system is filled with the refrigerant R134a. The refrigerant R134a contains fluorinated greenhouse gas.

**!** **NOTE** Damage due to incorrect refrigerant or refrigerant compressor oil

If the incorrect refrigerant or refrigerant compressor oil (PAG oil) is used, this can damage the climate control system.

- ▶ Use only R-134a refrigerant and the PAG oil approved for your vehicle by Mercedes-Benz.
- ▶ Do not mix the approved PAG oil with another PAG oil.

Maintenance work, such as refilling refrigerant or replacing components, may be carried out only by a qualified specialist workshop. All applicable regulations, as well as SAE standard J639, must be adhered to.

Have all work on the climate control system carried out at a qualified specialist workshop.

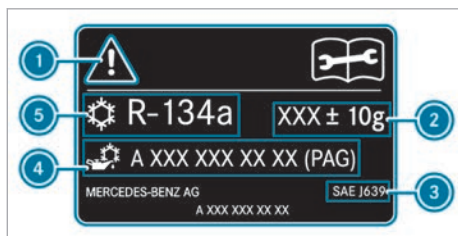

Example: refrigerant information label

- ① Symbols for hazard and service information
- ② Refrigerant capacity
- ③ Applicable standards
- ④ PAG oil part number
- ⑤ Refrigerant type

Symbols ① advise you of the following:

- Potential dangers
- Having maintenance work carried out at a qualified specialist workshop

## Vehicle data

### Vehicle dimensions

The following section contains important technical data for your vehicle. Your vehicle documents contain further vehicle-specific and equipment-dependent technical data such as vehicle dimensions and weights.

### High-voltage battery

#### Energy content and charging times

| High-voltage battery<br>81 kWh                                      |                    |
|---|--------------------|
| Type  | Lithium-ion        |
| Usable energy content   | 81 kWh             |
| Charging time – Mode 3<br>at up to 9.6 kW charging power            | approx. 9 h 30 min |
| Charging time – Mode 4<br>at up to 50 kW charging power             | approx. 1 h 7 min  |
| Charging time – Mode 4 (optional)<br>at up to 115 kW charging power | approx. 32 min     |

#### Energy content and charging times

| High-voltage battery<br>113 kWh                                     |                     |
|---|---------------------|
| Type  | Lithium-ion         |
| Usable energy content   | 113 kWh             |
| Charging time – Mode 3<br>at up to 9.6 kW charging power            | approx. 12 h 30 min |
| Charging time – Mode 4<br>at up to 50 kW charging power             | approx. 1 h 33 min  |
| Charging time – Mode 4 (optional)<br>at up to 115 kW charging power | approx. 42 min      |

Charging time – Mode 3 applies to AC charging from 0% to 100% of the usable battery capacity.

Charging time – Mode 4 applies to DC charging from 10% to 80% of the usable battery capacity.

The charging time depends on battery condition, ambient temperature and charging power. The

charging power depends on supply voltage, current and the type of power supply.

The charging time may be extended by the battery calibration function. Observe the notes on calibrating the high-voltage battery (→ page 166)

check compliance with weight restrictions before you start your journey.

## Trailer hitch

### Notes on the trailer hitch

**⚠ WARNING** Risk of accident due to impermissible attachment of a trailer tow hitch

If you install a trailer tow hitch or other components, the longitudinal frame member is weakened and can break. The trailer may become detached from the vehicle.

There is a risk of an accident.

Only retrofit a trailer tow hitch if permissible.

Observe the notes on trailer operation (→ page 138).

Retrofitting a trailer hitch is only permissible if a towing capacity is specified in your vehicle documents.

You can obtain further information on the trailer hitch at a qualified specialist workshop.

Mercedes-Benz recommends that you have a trailer hitch retrofitted at an authorized Mercedes-Benz Center.

Only use a trailer hitch which has been tested and specially approved by Mercedes-Benz for your vehicle.

Use only a ball neck that has been approved for your vehicle and for your Sprinter trailer hitch. Notes on the permissible dimensions of the ball neck can also be found on the identification plate of the trailer hitch.

The maximum permissible towing capacity for unbraked trailers is 1,653 lbs (750 kg).

### Trailer loads

The permissible weights and loads can also be obtained from the following sources of information:

- Vehicle documents
- The identification plates of the trailer hitch, trailer and vehicle

The values approved by the manufacturer can be found in the following table. If the figures differ, the lowest figure applies. Use calibrated scales to

**Maximum permissible weights and loads****Vehicle type, gross vehicle weight and curb weight**

| Vehicle model | Gross vehicle weight rating (GVWR) | Permissible curb weight <sup>7)</sup> |
|---------------|------------------------------------|---------------------------------------|
| 3500          | 9,900 lbs (4.490 t) (Canada only)  | 7840 lbs (3.556 t)                    |
|               | 9,989 lbs (4.531 t) (USA only)     |                                       |

<sup>7)</sup> Maximum permissible curb weight of a vehicle in ready-to-drive condition without driver or vehicle occupants, including all fluids and their reservoirs when filled up to 100%.

**Front axle load, rear axle load, gross weight of vehicle combination (standard, optional)**

**Vehicle type 3500 with a maximum gross vehicle weight rating of 9,900 lbs (4.490 t) (Canada only) and 9,989 lbs (4.531 t) (USA only)**

| Gross axle weight rating (GAWR), front axle (FA) | Gross axle weight rating (GAWR), rear axle (RA) |
|--|---|
| 4,080 lbs (1.851 t)                              | 7,060 lbs (3.202 t)                             |
| 4,410 lbs (2.000 t) <sup>1)</sup>                |   |

<sup>1)</sup> Front axle with increased load capacity.

**Gross vehicle combination weight, trailer load, tongue weight**

**Vehicle type 3500 with a maximum gross vehicle weight rating of 9,900 lbs (4.490 t) (Canada only)**

| Gross combined weight rating (GCWR) <sup>6), 9)</sup> | Gross trailer weight (GTW), braked <sup>6)</sup> | Tongue weight rating (TWR)      |
|---|--|---------------------------------|
| 15,250 lbs (6.917 t) <sup>3)</sup>                    | 7,500 lbs (3.402 t) <sup>3)</sup>                | 750 lbs (0.340 t) <sup>3)</sup> |

**Vehicle type 3500 with a maximum gross vehicle weight rating of 9,990 lbs (4.531 t) USA only)**

| Gross combined weight rating (GCWR) <sup>6), 9)</sup> | Gross trailer weight (GTW), braked <sup>6)</sup> | Tongue weight rating (TWR)      |
|---|--|---------------------------------|
| 15,250 lbs (6.917 t) <sup>3)</sup>                    | 7,500 lbs (3.402 t) <sup>3)</sup>                | 750 lbs (0.340 t) <sup>3)</sup> |

<sup>3)</sup> Only NAFTA trailer cross member, trailer load 7,500 lbs (3.400 t).

<sup>6)</sup> In trailer operation, do not exceed any individual maximum gross vehicle weight ratings specified in the table.

<sup>9)</sup> Any vehicle not equipped with a trailer coupling as standard cannot tow a trailer. In this case, the maximum gross vehicle weight rating will correspond to the maximum permissible gross weight for vehicle/trailer combination.

**i** If the trailer coupling is retrofitted, adapt the type plates accordingly with the altered maximum permissible weights. Please consult an authorized Mercedes-Benz Center if you have any further questions.

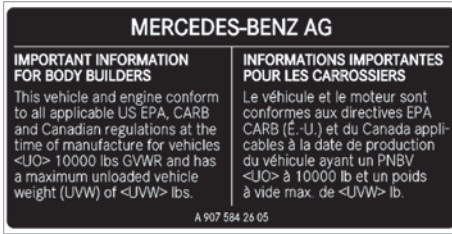

The bodybuilder label is found on the front-end module above the radiator and contains the vehicle's maximum permissible curb weight.

**Cargo tie-down points and carrier systems**

**Loading capacity of the cargo tie-down point and tie-down eyes**

**!** **NOTE** Risk of accident if the maximum loading capacity of the cargo tie-down points is exceeded

During maximum full-stop braking, for example, forces act that can multiply the weight force of the load.

- ▶ If various cargo tie-down points are combined to secure a load, always take the maximum loading capacity of the weakest cargo tie-down point into account.
- ▶ Always use several cargo tie-down points to distribute and spread the load. Distribute the load on the cargo tie-down points evenly.

Rated tensile force is the maximum permissible tensile force.

Further information on the cargo tie-down point and tie-down eyes can be obtained in the "Transporting" section (→ page 162).

**Tie-down eyes**

**Rated tensile force of tie-down eyes**

| Tie-down eyes | Rated tensile force   |
|---------------|-----------------------|
| Cargo Van     | 1 798.5 lbf (800 daN) |

**Loading rails**

**Rated tensile force of cargo tie-down point in the cargo compartment**

| Cargo tie-down point            | Rated tensile force   |
|---------------------------------|-----------------------|
| Loading rails on cargo floor    | 11 24.0 lbf (500 daN) |
| Lower loading rail on side wall | 449.6 lbf (200 daN)   |
| Upper loading rail on side wall | 281.0 lbf (125 daN)   |

The values specified apply only to loads resting on the cargo floor under the following conditions:

Conditions:

- the load is secured to two cargo tie-down point on the rail
- the distance to the nearest load-securing point on the same rail is approximately 3 ft (1 m).

**Information about roof luggage racks**

**!** **WARNING** Risk of injury if maximum roof load is exceeded

The vehicle center of gravity and the usual driving characteristics as well as the steering and braking characteristics will change.

If you exceed the maximum roof load, the handling as well as steering and braking characteristics are severely affected.

- ▶ Always comply with the maximum roof load and adjust your driving style.

**!** **WARNING** Danger of accident due to uneven loading

The driving characteristics, as well as steering and braking characteristics, may be greatly impaired.

- ▶ Load the vehicle evenly.
- ▶ Secure the load against sliding.

The driving, braking and steering characteristics of the vehicle will change with the type of load, the weight and the center of gravity of the load.

**I NOTE** Risk of accident if the maximum permissible roof load is exceeded

If the weight of the roof luggage, including the roof luggage rack, exceeds the maximum permissible roof load, there will be a risk of an accident.

- ▶ Ensure that the weight of the roof luggage and roof luggage rack does not exceed the maximum permissible roof load.
- ▶ The roof luggage rack supports must be arranged at an even distance from each other.

Further information about safety measures can be found in the "Transport" section (→ page 162).

#### Max. roof load/pairs of roof luggage rack supports

| Vehicles with | Maximum roof load   | Minimum number of pairs of supports |
|---------------|---------------------|-------------------------------------|
| Roof          | 661 lbs<br>(300 kg) | 6                                   |
| High roof     | 331 lbs<br>(150 kg) | 3                                   |

This information applies if the load is distributed evenly across the entire roof area.

If the roof luggage rack is shorter, reduce the load proportionately. The maximum load per pair of roof luggage rack supports is 110 lbs (50 kg).

The loading guidelines and other information about load distribution and load securing can be found in the "Transport" section (→ page 162).

## Display messages

### Introduction

#### Notes on display messages

**⚠ WARNING** Risk of accident due to an instrument cluster malfunction

In the event of a failure or malfunction of the instrument cluster, you will not recognize limitations in the functions of systems relevant to safety. This may impair operating safety.

▶ Park the vehicle safely as soon as possible and notify a qualified specialist workshop.

The on-board computer shows messages and warnings from specific systems on the instrument cluster display. Ensure that your vehicle is operating safely at all times.

Display messages with graphical symbols may appear in simplified form in the Operator's Manual and differ from the symbols on the driver display. The instrument cluster shows high-priority display messages in red. A warning tone will also sound for specific display messages.

Please act in accordance with the display messages and follow the additional notes in this Operator's Manual.

In addition, symbols are shown for some display messages:

- ⓘ Further information
- ✕ Hiding display messages

You can select the respective symbol by swiping left or right on the left Touch Control. Press ⓘ to display further information on the media display. Pressing ✕ hides the display message.

You can hide display messages to be acknowledged by pressing the back button  or with the left Touch Control. The display messages will be saved to the message memory.

Rectify the cause of a display message as quickly as possible.

High-priority display messages cannot be hidden. The instrument cluster will show these display messages permanently until the cause of the display message has been rectified.





#### Calling up saved display messages



The on-board computer saves specific display messages to the message memory. You can call up the

saved display messages. Use the buttons on the left control panel on the steering wheel.





- ▶ Select the **Service** menu by swiping to the left or right on the Touch Control.
- ▶ Swipe upwards or downwards on the Touch Control. The bar will show the number of saved messages. If there are no messages stored, the display will show **No Messages**.
- ▶ Confirm with the Touch Control and scroll through the stored messages by swiping upwards or downwards.



## Occupant safety

| Display messages   | Possible causes/consequences and ► Solutions   |
|--|--|
|  <p>Left Window Airbag Fault Service Required (example)</p> | <p>* The restraint system is malfunctioning (→ page 28).</p> <p><b>▲ WARNING</b> Risk of injury or fatal injury due to a malfunction in the window curtain airbag</p> <p>The window curtain airbag might be triggered unintentionally or might not be triggered at all in the event of an accident.</p> <p>► Have the window curtain airbag checked and repaired immediately at a qualified specialist workshop.</p> <p>► Consult a qualified specialist workshop immediately.</p>   |
|  <p>Restraint System Fault Service Required</p>             | <p>* The restraint system is malfunctioning (→ page 28).</p> <p><b>▲ DANGER</b> Risk of death due to the restraint system malfunctioning</p> <p>Components in the restraint system may be activated unintentionally or not deploy as intended in an accident. In the event of an accident, the high-voltage on-board electrical system may not be deactivated as intended.</p> <p>You may receive an electric shock if you touch the damaged components of the high-voltage on-board electrical system.</p> <p>► Have the restraint system checked and repaired immediately at a qualified specialist workshop.</p> <p>► After an accident, switch off the vehicle immediately.</p> <p>Recognition of a restraint system malfunction:</p> <ul style="list-style-type: none"> <li>• The  restraint system warning lamp does not light up when the vehicle is switched on.</li> <li>• The  restraint system warning lamp lights up continuously or repeatedly during a journey.</li> </ul> <p>► Consult a qualified specialist workshop immediately.</p> |
|  <p>Front Left Fault Service Required (example)</p>       | <p>* The restraint system is malfunctioning (→ page 28).</p> <p><b>▲ DANGER</b> Risk of death due to the restraint system malfunctioning</p> <p>Components in the restraint system may be activated unintentionally or not deploy as intended in an accident. In the event of an accident, the high-voltage on-board electrical system may not be deactivated as intended.</p> <p>You may receive an electric shock if you touch the damaged components of the high-voltage on-board electrical system.</p> <p>► Have the restraint system checked and repaired immediately at a qualified specialist workshop.</p> <p>► After an accident, switch off the vehicle immediately.</p>  |

| Display messages | Possible causes/consequences and ► Solutions  |
|------------------|---|
|                  | <p>Identifying a restraint system malfunction:</p> <ul style="list-style-type: none"> <li>• The  restraint system warning lamp does not light up when the vehicle is switched on.</li> <li>• The  restraint system warning lamp lights up continuously or repeatedly during a journey.</li> </ul> <p>► Consult a qualified specialist workshop immediately.</p> |

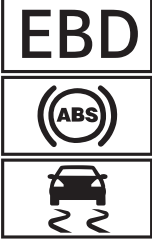

**Driving and driving safety systems**

| Display messages   | Possible causes/consequences and ► Solutions   |
|--|--|
|   <p>Inoperative See Operator's Manual</p>               | <p>* ABS and ESP<sup>®</sup> are malfunctioning.</p> <p>Other driving systems and driving safety systems (e.g. BAS) may also be malfunctioning.</p> <p>The brake system continues working with the normal effect. Braking distance may increase in an emergency braking situation.</p> <p><b>▲ WARNING</b> Risk of skidding if ABS and ESP<sup>®</sup> are malfunctioning</p> <p>The wheels may block during braking and ESP<sup>®</sup> does not perform any vehicle stabilization.</p> <p>The steerability and braking characteristics are heavily impaired and the braking distance may increase. In addition, other driving safety systems are switched off.</p> <ul style="list-style-type: none"> <li>► Drive on carefully.</li> <li>► Have ABS and ESP<sup>®</sup> checked immediately at a qualified specialist workshop.</li> </ul>   |
|   <p>Currently Unavailable See Operator's Manual</p> | <p>* ABS and ESP<sup>®</sup> are temporarily unavailable.</p> <p>Other driving systems and driving safety systems (e.g. BAS) may also be temporarily unavailable.</p> <p>The brake system continues working with the normal effect. Braking distance may increase in an emergency braking situation.</p> <p><b>▲ WARNING</b> Risk of skidding if ABS and ESP<sup>®</sup> are malfunctioning</p> <p>The wheels may lock during braking and ESP<sup>®</sup> does not perform any vehicle stabilization.</p> <p>The steerability and braking characteristics are heavily impaired and the braking distance may increase. In addition, other driving safety systems are switched off.</p> <ul style="list-style-type: none"> <li>► Drive carefully on a suitable stretch of road, making slight steering movements at a speed above 19 mph (30 km/h).</li> <li>► If the display message does not disappear, consult a qualified specialist workshop immediately. Drive carefully.</li> </ul> |

| Display messages  | Possible causes/consequences and ► Solutions  |
|---|---|
|  <p data-bbox="207 351 422 399">Inoperative See Operator's Manual</p>  | <p data-bbox="484 259 710 286">* ESP® is malfunctioning</p> <p data-bbox="501 295 1115 345">Other driving systems and driving safety systems (e.g. BAS) may also be malfunctioning.</p> <p data-bbox="501 354 1109 404">The brake system continues working with the normal effect. Braking distance may increase in an emergency braking situation.</p> <div data-bbox="501 417 1126 596" style="border: 1px solid black; padding: 5px;"> <p data-bbox="514 430 1023 456"><b>▲ WARNING</b> Risk of skidding if ESP® is malfunctioning</p> <p data-bbox="518 469 1106 519">If ESP® is malfunctioning, ESP® cannot carry out vehicle stabilization. In addition, other driving safety systems are switched off.</p> <ul data-bbox="518 528 1037 587" style="list-style-type: none"> <li data-bbox="518 528 714 555">► Drive on carefully.</li> <li data-bbox="518 560 1037 587">► Have ESP® checked at a qualified specialist workshop.</li> </ul> </div>   |
|  <p data-bbox="207 704 422 752">Currently Unavailable See Operator's Manual</p>                                | <p data-bbox="484 612 786 639">* ESP® is temporarily unavailable.</p> <p data-bbox="501 648 1093 698">Other driving systems and driving safety systems may also be malfunctioning.</p> <div data-bbox="501 711 1126 937" style="border: 1px solid black; padding: 5px;"> <p data-bbox="514 723 1023 750"><b>▲ WARNING</b> Risk of skidding if ESP is malfunctioning®</p> <p data-bbox="518 763 1106 813">If ESP® is malfunctioning, ESP® cannot carry out vehicle stabilization. In addition, other driving safety systems are switched off.</p> <ul data-bbox="518 822 1071 931" style="list-style-type: none"> <li data-bbox="518 822 1071 872">► Drive carefully on a suitable stretch of road, making slight steering movements at a speed above 19 mph (30 km/h).</li> <li data-bbox="518 878 1071 931">► If the display message does not disappear, consult a qualified specialist workshop immediately. Drive carefully.</li> </ul> </div>   |
|  <p data-bbox="207 1211 422 1286">Inoperative See Operator's Manual<br/>Inoperative See Operator's Manual</p> | <p data-bbox="484 958 1106 1033">* EBD is unavailable due to a malfunction. This means that ABS, BAS, Hill Start Assist and ESP® as well as its driving safety systems, for example, are also unavailable.</p> <p data-bbox="501 1042 1119 1093">ATTENTION ASSIST is deactivated and other driving systems could be automatically deactivated.</p> <p data-bbox="501 1102 1080 1152">The brake system continues to function normally, but without the functions listed above.</p> <div data-bbox="501 1164 1126 1471" style="border: 1px solid black; padding: 5px;"> <p data-bbox="514 1177 1076 1227"><b>▲ WARNING</b> Risk of skidding if EBD, ABS and ESP® are malfunctioning</p> <p data-bbox="518 1240 1102 1290">The wheels may block during braking and ESP® does not perform any vehicle stabilization.</p> <p data-bbox="518 1299 1093 1374">The steerability and braking characteristics are heavily impaired and the braking distance may increase. In addition, other driving safety systems are switched off.</p> <ul data-bbox="518 1383 1071 1467" style="list-style-type: none"> <li data-bbox="518 1383 714 1410">► Drive on carefully.</li> <li data-bbox="518 1415 1071 1467">► Have the brake system checked immediately at a qualified specialist workshop.</li> </ul> </div> |
| <p data-bbox="207 1490 402 1541">120 km/h Maximum Speed Exceeded</p>  | <p data-bbox="484 1490 1119 1541">* For certain countries only: the maximum permissible speed has been exceeded.</p> <ul data-bbox="501 1550 701 1575" style="list-style-type: none"> <li data-bbox="501 1550 701 1575">► Drive more slowly.</li> </ul>   |

| Display messages   | Possible causes/consequences and ► Solutions  |
|--|---|
| <p>Speed Limit (Winter Tires) XXX mph</p>  | <p>* You have reached the maximum permissible stored speed for winter tires. It is not possible to exceed this speed.</p>   |
| <div data-bbox="194 333 347 413" data-label="Image"> </div> <p>ATTENTION ASSIST:<br/>Take a Break!</p> | <p>* Based on certain criteria, ATTENTION ASSIST has detected fatigue or increasing lapses in concentration on the part of the driver. A warning tone also sounds.</p> <p>► If necessary, take a break.</p> <p>On long journeys, take regular and timely breaks that allow you to rest properly.</p>  |
| <div data-bbox="194 530 347 611" data-label="Image"> </div> <p>ATTENTION ASSIST Inoperative</p>        | <p>* ATTENTION ASSIST has failed.</p> <p>► Consult a qualified specialist workshop.</p>   |
| <div data-bbox="194 691 347 772" data-label="Image"> </div> <p>--- mph</p>                             | <p>* Cruise control cannot be activated as not all activation conditions have been met.</p> <p>► Observe the activation conditions for cruise control (→ page 125).</p>   |
| <p>Cruise Control Inoperative</p>  | <p>* Cruise control is malfunctioning.</p> <p>► Consult a qualified specialist workshop.</p>  |
| <div data-bbox="194 899 347 980" data-label="Image"> </div> <p>Off</p>                                 | <p>* The HOLD function has been deactivated. The vehicle has started skidding. A warning tone also sounds.</p> <p>► Switch the HOLD function on again later (→ page 130).</p> <p>* The HOLD function has been deactivated. An activation condition will no longer be met when the brake pedal is depressed. A warning tone also sounds.</p> <p>► Check the activation conditions of the HOLD function (→ page 129).</p> |

Driver assistance systems

| Display messages   | Possible causes/consequences and ► Solutions   |
|--|--|
|  <p data-bbox="207 637 429 688">Temporarily Unavailable<br/>Sensors Dirty</p>           | <p data-bbox="484 301 1119 351">* Front and corner radar sensors (hereafter "sensors") are malfunctioning. Possible causes:</p> <ul data-bbox="510 360 1102 453" style="list-style-type: none"> <li>• the sensors are dirty</li> <li>• heavy precipitation</li> <li>• extended country driving without other traffic, e.g. in the desert</li> </ul> <p data-bbox="501 467 1115 542">Driving systems and driving safety systems may be malfunctioning or temporarily unavailable. The brake system, steering and drive system will continue to function normally.</p> <p data-bbox="501 551 698 578">► Drive on carefully.</p> <p data-bbox="501 598 1093 673">Once the causes of the problem are no longer present, the driving systems and driving safety systems will be available again, and the corresponding symbols will be switched off.</p> <p data-bbox="501 682 883 709">If the display message does not disappear:</p> <ul data-bbox="501 718 1037 811" style="list-style-type: none"> <li>► Stop in accordance with the traffic conditions.</li> <li>► Clean all sensor covers from the outside (→ page 119).</li> <li>► Restart the vehicle.</li> </ul>   |
|  <p data-bbox="207 1241 429 1292">Camera View Restricted<br/>See Operator's Manual</p> | <p data-bbox="484 824 1102 851">* The view of the multifunction camera is restricted. Possible causes:</p> <ul data-bbox="510 860 1119 1026" style="list-style-type: none"> <li>• Dirt on the windshield in the field of vision of the multifunction camera</li> <li>• Heavy precipitation or fog</li> <li>• Mist on the inside or outside of the windshield: In certain weather conditions, mist can form on the inside or outside of the windshield during cold times of year in particular.</li> </ul> <p data-bbox="501 1041 1126 1091">ⓘ This mist on the windshield will be removed automatically within a short time with the aid of a heater. The restriction is temporary.</p> <p data-bbox="501 1100 1115 1175">Driving systems and driving safety systems may be malfunctioning or temporarily unavailable. The brake system, steering and drive system will continue to function normally.</p> <ul data-bbox="501 1184 1089 1277" style="list-style-type: none"> <li>► Drive on carefully.</li> <li>► To remove the mist from the outside, wipe once (→ page 80).</li> <li>► To remove the mist from the inside, press  (→ page 89).</li> </ul> <p data-bbox="501 1297 1093 1372">Once the causes of the problem are no longer present, the driving systems and driving safety systems will be available again, and the corresponding symbols will be switched off.</p> <p data-bbox="501 1381 1119 1431">If the display message does not disappear even after a driving time of about 15 minutes:</p> <ul data-bbox="501 1440 1106 1553" style="list-style-type: none"> <li>► Stop in accordance with the traffic conditions.</li> <li>► Clean the windshield, especially in the position of the multifunction camera (→ page 119).</li> <li>► Restart the vehicle.</li> </ul> |



| Display messages   | Possible causes/consequences and ► Solutions   |
|--|--|
| <p>Active Distance Assist Inoperative</p>  | <p>* Active Distance Assist DISTRONIC is malfunctioning.<br/>Other driving systems and driving safety systems may also be malfunctioning.</p> <ul style="list-style-type: none"> <li>► Drive on carefully.</li> <li>or</li> <li>► Stop the vehicle in accordance with the traffic conditions and restart the vehicle.</li> <li>► If the display message does not disappear: consult a qualified specialist workshop.</li> </ul>  |
| <p>Active Distance Assist Currently Unavailable<br/>See Operator's Manual</p>                | <p>* A warning tone also sounds.<br/>Active Distance Assist DISTRONIC has been switched off and is temporarily non-operational.<br/>The following causes are possible:</p> <ul style="list-style-type: none"> <li>• The function is impaired due to heavy rain or snow.</li> <li>• The radar sensor system is temporarily non-operational, e.g. due to electromagnetic radiation close to TV or radio transmitting stations or other sources of radiation.</li> <li>• The system is outside the operating temperature range.</li> <li>• The on-board electrical system voltage is too low.</li> </ul> <p>If the causes mentioned above no longer apply, the display message will disappear, and Active Distance Assist DISTRONIC will be operational again.<br/>If the display message does not disappear:</p> <ul style="list-style-type: none"> <li>► Stop in accordance with the traffic conditions.</li> <li>► Secure the vehicle against rolling away.</li> <li>► Restart the vehicle.</li> </ul> |
| <p>Active Distance Assist Available Again</p>  | <p>* Active Distance Assist DISTRONIC is operational again after being temporarily unavailable. You can now switch Active Distance Assist DISTRONIC on again (→ page 128).</p>   |
| <p>Blind Spot Assist and Exiting Warning Currently Unavailable<br/>See Operator's Manual</p> | <p>* Blind Spot Assist is temporarily non-operational.<br/>The following causes are possible:</p> <ul style="list-style-type: none"> <li>• The sensors in the rear bumper are dirty.</li> <li>• The function is impaired due to heavy rain or snow.</li> <li>• The radar sensor system is temporarily non-operational, e.g. due to electromagnetic radiation close to TV or radio transmitting stations or other sources of radiation.</li> <li>• The system is outside the operating temperature range.</li> </ul> <p>If the causes mentioned above no longer apply, the display message will disappear, and Blind Spot Assist will be operational again.<br/>If the display message does not disappear:</p> <ul style="list-style-type: none"> <li>► Stop in accordance with the traffic conditions.</li> <li>► Secure the vehicle against rolling away.</li> <li>► Switch off the vehicle.</li> </ul>   |

| Display messages   | Possible causes/consequences and ► Solutions  |
|--|---|
|  | <ul style="list-style-type: none"> <li>► Clean the sensors in the rear bumper (→ page 173).</li> <li>► Restart the vehicle.</li> </ul>  |
| Blind Spot Assist and Exit Warning Inoperative                                 | <p>* Blind Spot Assist is malfunctioning.</p> <ul style="list-style-type: none"> <li>► Consult a qualified specialist workshop.</li> </ul>  |
| Blind Spot Assist Trailer Not Monitored  | <p>* When you establish an electrical connection with the trailer, Blind Spot Assist will remain available but the area beside the trailer will not be monitored. The function of Blind Spot Assist may be restricted as a result (→ page 132).</p> <ul style="list-style-type: none"> <li>► Acknowledge the display message by pressing the left-hand Touch Control on the multifunction steering wheel.</li> </ul>  |
| Active Lane Keeping Assist Reduced Range of Functions See Operator's Manual    | <p>* Active Lane Keeping Assist is available but restricted.</p> <ul style="list-style-type: none"> <li>► Drive on.</li> </ul> <p>or</p> <ul style="list-style-type: none"> <li>► Stop the vehicle in accordance with the traffic conditions and restart the vehicle.</li> <li>► If the display message does not disappear: consult a qualified specialist workshop.</li> </ul>   |
| Active Lane Keeping Assist Currently Unavailable See Operator's Manual         | <p>* Active Lane Keeping Assist is temporarily unavailable. The following causes are possible:</p> <ul style="list-style-type: none"> <li>• The windshield is dirty in the camera's field of vision.</li> <li>• Visibility is impaired due to heavy rain, snow or fog.</li> <li>• Lane markings are absent for a long period of time.</li> <li>• The lane markings are worn, dark or covered by dirt or snow, for example.</li> </ul> <p>If the causes mentioned above no longer apply, the display message will disappear and Active Lane Keeping Assist will be operational again.</p> <p>If the display message does not disappear:</p> <ul style="list-style-type: none"> <li>► Stop in accordance with the traffic conditions.</li> <li>► Secure the vehicle against rolling away.</li> <li>► Clean the windshield.</li> </ul> |
| Active Lane Keeping Assist Inoperative   | <p>* Active Lane Keeping Assist is malfunctioning .</p> <ul style="list-style-type: none"> <li>► Drive on.</li> </ul> <p>or</p> <ul style="list-style-type: none"> <li>► Stop the vehicle in accordance with the traffic conditions and restart the vehicle.</li> <li>► If the display message does not disappear: consult a qualified specialist workshop.</li> </ul>  |
| Active Brake Assist Range of Functions Currently Reduced See Operator's Manual | <p>* Active Brake Assist may be temporarily unavailable or only partially available.</p>  |

| Display messages  | Possible causes/consequences and ► Solutions   |
|---|--|
|   | <p>The following causes are possible:</p> <ul style="list-style-type: none"> <li>• The sensors in the front bumper are dirty.</li> <li>• The area of the windshield where the camera is located is dirty.</li> <li>• The function is impaired due to heavy rain or snow.</li> <li>• The radar sensor system is temporarily non-operational, e.g. due to electromagnetic radiation close to TV or radio transmitting stations or other sources of radiation.</li> <li>• The system is outside the operating temperature range.</li> <li>• The on-board electrical system voltage is too low.</li> </ul> <p>If the causes mentioned above no longer apply, the display message will disappear. Active Brake Assist is operational again.</p> <p>If the display message does not disappear:</p> <ul style="list-style-type: none"> <li>► Stop in accordance with the traffic conditions.</li> <li>► Secure the vehicle against rolling away.</li> <li>► Switch off the vehicle.</li> <li>► Clean the area of the windshield where the camera is located (→ page 173).</li> <li>► Clean the sensors in the front bumper (→ page 173).</li> <li>► Start the vehicle again.</li> </ul> |
| <p>Active Brake Assist<br/>Reduced Range of Functions See Operator's Manual</p> | <p>* Active Brake Assist may be temporarily unavailable or only partially available.</p> <ul style="list-style-type: none"> <li>► Drive on carefully.</li> </ul> <p>or</p> <ul style="list-style-type: none"> <li>► Stop the vehicle in accordance with the traffic conditions and restart the vehicle.</li> <li>► If the display message does not disappear: consult a qualified specialist workshop.</li> </ul>  |



### Climate control

| Display messages  | Possible causes/consequences and ► Solutions  |
|---|---|
| <p>Pre-entry Climate Control Available Again via Week Profile after Vehicle Start</p> | <p>* Pre-entry climate control was activated more than three times during a week profile without a journey taking place. The function has been deactivated in order to conserve energy.</p> <ul style="list-style-type: none"> <li>► Start the vehicle for ten seconds.<br/>Pre-entry climate control will be operational again.</li> </ul> |
| <p>Pre-entry Climate Control via Key Available Again After Vehicle Start</p>          | <p>* You have attempted to switch on pre-entry climate control more than three times with the engine switched off.</p> <ul style="list-style-type: none"> <li>► Let the drive system run for ten seconds.<br/>Pre-entry climate control will be operational again.</li> </ul>   |
| <p>Pre-entry Climate Control via Key Inoperative High-Voltage Battery Low</p>         | <p>* The high-voltage battery's state of charge is too low. Pre-entry climate control cannot be switched on.</p>  |







| Display messages   | Possible causes/consequences and ► Solutions  |
|--|---|
|  <p>Currently Unavailable<br/>Charging of High-Voltage Battery Incomplete</p> | <ul style="list-style-type: none"> <li>► Charge the high-voltage battery (→ page 107).<br/>When the high-voltage battery is sufficiently charged, pre-entry climate control will be operational again.</li> </ul> <p>* The high-voltage battery is charging. Pre-entry climate control cannot be switched on.</p> <ul style="list-style-type: none"> <li>► Wait until the charging process has achieved a minimum state of charge.</li> </ul> |
|  <p>Currently Unavailable<br/>Charge High-Voltage Battery</p>                 | <p>* The high-voltage battery's state of charge is too low. Pre-entry climate control cannot be switched on.</p> <ul style="list-style-type: none"> <li>► Charge the high-voltage battery (→ page 107).</li> </ul>  |
| <p>Heating/Air Conditioning Energy Saving Mode Active</p>  | <p>* The air-conditioning energy-saving mode is active (→ page 87).</p>   |







### Drive system

| Display messages  | Possible causes/consequences and ► Solutions   |
|---|--|
| <p>To Ensure Max. Range, Perform Battery Calibration Start Charge Process to 100%</p>   | <p>* The high-voltage battery is not calibrated.</p> <ul style="list-style-type: none"> <li>► Calibrate the high-voltage battery (→ page 166).</li> </ul>  |
| <p>To Ensure Max. Range, Perform Battery Calibration Extra Charging Time: XX min Start AC Charging to 100%</p>                | <p>* The high-voltage battery is not calibrated.</p> <ul style="list-style-type: none"> <li>► Calibrate the high-voltage battery (→ page 166).</li> </ul>  |
| <p>Battery Calibration Required AC Charging to 100% Start Possible at State of Charge: Max. XX% Outside Temp.: Min. XX °F</p> | <p>* The high-voltage battery is not calibrated.</p> <ul style="list-style-type: none"> <li>► Calibrate the high-voltage battery (→ page 166).</li> </ul>  |
| <p>Wait in READY State Battery Is Warming Up See Operator's Manual</p>  | <p>* Operational readiness is established <b>READY</b> and transmission position <b>P</b> is engaged.</p> <p>The high-voltage battery is being warmed up to the operating temperature. This process can take a few minutes and may be prolonged if windshield defrosting <b>MAX</b> is activated.</p> <p>The heating process will end when transmission position <b>D</b> is engaged. When you are driving, however, the output will be signifi-</p> |

| Display messages  | Possible causes/consequences and ► Solutions   |
|---|--|
|   | cantly limited until the high-voltage battery has reached its operating temperature.   |
| Cannot Start Vehicle<br>See Operator's Manual   | * It is not possible to start the vehicle.<br>A malfunction has occurred in the drive system. <ul style="list-style-type: none"> <li>► Switch the vehicle off and lock it.</li> <li>► After waiting for a short time, unlock the vehicle and start it again.</li> <li>► If the display message appears again and the vehicle does not start, consult a qualified specialist workshop.</li> </ul> |
| <br>Charging Cable Connected           | * You cannot pull away while the charging cable is connected. <ul style="list-style-type: none"> <li>► Disconnect the charging cable from the vehicle.</li> </ul>  |
| <br>Reserve Level High-Voltage Battery | * The state of charge of the high-voltage battery has reached the reserve level. <ul style="list-style-type: none"> <li>► Charge the high-voltage battery (→ page 107).</li> </ul>   |
| Please Charge High-Voltage Battery if Vehicle will be Parked for an Extended Period at Low Outside Temperatures.        | * Due to a possible drop in the temperature of the high-voltage battery, the starting ability or the range may drop significantly until the vehicle is restarted. <ul style="list-style-type: none"> <li>► Charge the high-voltage battery (→ page 107).</li> </ul>  |
| Do Not Restart Vehicle<br>Service Required  | * The drive system cannot be restarted due to a malfunction. <ul style="list-style-type: none"> <li>► Do not switch off the vehicle; drive on to the nearest qualified specialist workshop.</li> </ul>   |
| Vehicle Currently Not Being Charged<br>Charging Station Fault   | * A malfunction has occurred in the charging station or the RFID card is not recognized. <ul style="list-style-type: none"> <li>► Start the charging process at a different charging station.</li> <li>or</li> <li>► Have the RFID card checked to ensure it is working properly.</li> </ul>   |
| AC Charging Inoperative<br>Service Required   | * The charging process cannot be started due to a malfunction. <ul style="list-style-type: none"> <li>► Consult a qualified specialist workshop.</li> </ul>  |
| DC Charging Inoperative<br>Service Required   | * The charging process cannot be started due to a malfunction. <ul style="list-style-type: none"> <li>► Consult a qualified specialist workshop.</li> </ul>  |
| Authentication Failed<br>Use Different Authentication Method or Charging Station  | * Plug-and-Charge is not expected to be available at this charging station. <ul style="list-style-type: none"> <li>► Use an alternative authentication method or payment method.</li> <li>or</li> <li>► Start the charging process at a different charging station.</li> </ul>   |

| Display messages   | Possible causes/consequences and ► Solutions   |
|--|--|
| <p>Charging Mode Currently Unavailable Try Again or Change Charging Mode</p>   | <p>* A temporary malfunction has occurred on the charging station.</p> <ul style="list-style-type: none"> <li>► Wait until the malfunction has passed.</li> <li>or</li> <li>► Start the charging process at a different charging station.</li> </ul>   |
| <p>Charging Fault Change Charging Mode See Operator's Manual</p>   | <p>* A temporary malfunction has occurred on the charging station.</p> <ul style="list-style-type: none"> <li>► Wait until the malfunction has passed.</li> <li>or</li> <li>► Start the charging process at a different charging station.</li> </ul>   |
| <p>Not Possible to Unlock Charging Cable See Operator's Manual</p>   | <p>* The charging cable connector cannot be removed from the charging station's socket.</p> <ul style="list-style-type: none"> <li>► Press the EMERGENCY OFF switch on the charging station.</li> </ul> <p>If the charging cable connector cannot be removed after that:</p> <ul style="list-style-type: none"> <li>► Request service personnel from the operator of the charging station via the emergency call button attached to the charging station or the emergency call numbers.</li> </ul>   |
| <div data-bbox="215 766 368 849" data-label="Image"> </div> <p>Refill Coolant See Operator's Manual</p>                      | <p>* The coolant level is too low.</p> <div data-bbox="505 802 1126 888" data-label="Complex-Block" style="border: 1px solid black; padding: 5px;"> <p><b>NOTE</b> Damage to the drive system due to insufficient coolant</p> <ul style="list-style-type: none"> <li>► Avoid long journeys with insufficient coolant.</li> </ul> </div> <ul style="list-style-type: none"> <li>► Have the cooling system of the drive system checked at a qualified specialist workshop.</li> </ul>  |
| <div data-bbox="215 969 368 1051" data-label="Image"> </div> <p>Cooling System Fault Stop Immediately Switch Off Vehicle</p> | <p>* The coolant is too hot.</p> <ul style="list-style-type: none"> <li>► Stop the vehicle immediately in accordance with the traffic conditions and switch off the drive system.</li> </ul> <div data-bbox="505 1076 1126 1399" data-label="Complex-Block" style="border: 1px solid black; padding: 5px;"> <p><b>WARNING</b> Risk of injury due to overheated vehicle</p> <p>If you open the hood in the event of an overheated vehicle or fire in the engine compartment, the following situations may occur:</p> <ul style="list-style-type: none"> <li>• You may come into contact with hot gases.</li> <li>• You may come into contact with other escaping hot operating fluids.</li> </ul> <ul style="list-style-type: none"> <li>► In the event of overheating or fire in the engine compartment, keep the hood closed and call the fire service.</li> <li>► Allow the overheated vehicle to cool down first if you need to open the hood.</li> </ul> </div> <ul style="list-style-type: none"> <li>► Wait until the drive system has cooled down.</li> <li>► Make sure that the air supply to the vehicle radiator is not obstructed.</li> <li>► Avoiding high loads on the drive system, drive to the nearest qualified specialist workshop.</li> </ul> |









| Display messages   | Possible causes/consequences and ► Solutions   |
|--|--|
|  <p>Cooling System Fault<br/>Reduced Drive Power<br/>Service Required</p> | <ul style="list-style-type: none"> <li>* The cooling system has detected a component malfunction.                             <ul style="list-style-type: none"> <li>► Avoiding high loads on the drive system, drive to the nearest qualified specialist workshop.</li> </ul> </li> </ul>   |
|  <p>Towing Not Permitted<br/>See Operator's Manual</p>                    | <ul style="list-style-type: none"> <li>* The drive system is malfunctioning.                             <ul style="list-style-type: none"> <li>► Have the vehicle transported only using a transporter or trailer (→ page 181).</li> </ul> </li> </ul>  |
|  <p>Acoustic Ambient Protection Inoperative</p>                           | <ul style="list-style-type: none"> <li>* The sound generator (acoustic vehicle alerting system) is malfunctioning. No vehicle noise is being produced. As a result, your vehicle may not be heard by other road users in certain situations.                             <ul style="list-style-type: none"> <li>► Drive with particular care.</li> <li>► Consult a qualified specialist workshop.</li> </ul> </li> </ul>   |
| <p>Reduced Drive Power<br/>See Operator's Manual</p>   | <ul style="list-style-type: none"> <li>* The drive system is outside the operating temperature range, e.g. due to extreme outside temperatures.<br/>Drive system power output is reduced. The yellow reduced power warning lamp  is lit.                             <ul style="list-style-type: none"> <li>► Drive on carefully.</li> <li>Once the operating conditions return to normal, the full output will be available again.</li> </ul> </li> <li>* The high-voltage battery is not charged sufficiently.<br/>Drive system power output is reduced. The yellow reduced power warning lamp  is lit.                             <ul style="list-style-type: none"> <li>► Drive on carefully.</li> <li>► Charge the high-voltage battery immediately.</li> </ul> </li> <li>* If the drive system power output is still reduced, there is a malfunction in the drive system.                             <ul style="list-style-type: none"> <li>► Drive on carefully.</li> <li>► Consult a qualified specialist workshop.</li> </ul> </li> </ul> |
|  <p>Have High-Voltage System Checked See Operator's Manual</p>          | <ul style="list-style-type: none"> <li>* A function restriction has occurred in the drive system.                             <ul style="list-style-type: none"> <li>► Consult a qualified specialist workshop.</li> </ul> </li> </ul>   |
|  <p>Fault</p>   | <ul style="list-style-type: none"> <li>* The drive system is malfunctioning. A warning tone also sounds.                             <ul style="list-style-type: none"> <li>► Consult a qualified specialist workshop.</li> </ul> </li> <li>* There is a serious malfunction if the display message and warning tone are repeated at short intervals. You must stop the vehicle immediately in accordance with the traffic conditions because the drive system is automatically deactivated.</li> </ul>  |





| Display messages  | Possible causes/consequences and ► Solutions  |
|---|---|
|   | <ul style="list-style-type: none"> <li>► Stop the vehicle immediately in accordance with the traffic conditions.</li> <li>► Switch off the vehicle and consult a qualified specialist workshop.</li> </ul>  |
|  <p data-bbox="207 446 431 521"><b>Battery Overheated</b><br/>Stop! Everyone Get Out!<br/>Outdoors if Possible</p> | <ul style="list-style-type: none"> <li>* The high-voltage battery has overheated. There is a risk of fire.</li> <li>► Stop the vehicle immediately in accordance with the traffic conditions.</li> <li>► If possible, park the vehicle in a clear area and make sure that all occupants exit the vehicle.</li> <li>► Do not drive on.</li> <li>► If smoke is present, leave the danger zone and call the fire department immediately.</li> <li>► Consult a qualified specialist workshop even if there are no external signs of a fire.</li> </ul>  |
|  <p data-bbox="207 754 415 775"><b>Fault Service Required</b></p>  | <ul style="list-style-type: none"> <li>* The drive system is malfunctioning.</li> <li>► Consult a qualified specialist workshop.</li> </ul>   |
|  <p data-bbox="207 890 425 912"><b>Power Severely Limited</b></p>  | <ul style="list-style-type: none"> <li>* A malfunction has occurred in the high-voltage battery. Output and range will be severely restricted.</li> <li>► Switch the vehicle off and lock it.</li> <li>► After waiting for a short time, unlock the vehicle and start it again.</li> </ul> <p data-bbox="501 947 836 969">If the display message appears again:</p> <ul style="list-style-type: none"> <li>► Drive on carefully.</li> <li>► Fully charge the high-voltage battery (→ page 107).</li> </ul> <p data-bbox="501 1064 1115 1109">If the output and range are still reduced, there is a malfunction in the drive system.</p> <ul style="list-style-type: none"> <li>► Drive on carefully.</li> <li>► Consult a qualified specialist workshop.</li> </ul> |
|  <p data-bbox="207 1284 425 1306"><b>Stop Switch Off Vehicle</b></p>   | <ul style="list-style-type: none"> <li>* The drive system is malfunctioning.</li> <li>► Stop the vehicle immediately in accordance with the traffic conditions. Do not continue driving!</li> <li>► Contact a qualified specialist workshop.</li> </ul>   |
|  <p data-bbox="207 1421 257 1442"><b>Fault</b></p>   | <ul style="list-style-type: none"> <li>* The drive system is malfunctioning. The output of your vehicle is restricted.</li> <li>► Consult a qualified specialist workshop.</li> </ul>   |
|  <p data-bbox="207 1557 415 1578"><b>Fault Service Required</b></p>  | <ul style="list-style-type: none"> <li>* The drive system is malfunctioning.</li> <li>► Consult a qualified specialist workshop.</li> </ul>   |

| Display messages  | Possible causes/consequences and ► Solutions   |
|---|--|
| Observe Range   | <ul style="list-style-type: none"> <li>* The usable capacity of the high-voltage battery system has changed.                             <ul style="list-style-type: none"> <li>► Observe the modified range that is displayed.</li> </ul> </li> </ul>   |
| Observe Range Service Required  | <ul style="list-style-type: none"> <li>* A battery in the battery compound is malfunctioning.                             <ul style="list-style-type: none"> <li>► Consult a qualified specialist workshop.</li> <li>► Observe the modified range.</li> </ul> </li> </ul>  |
| High-Voltage Battery Fault No Start in Approx. XXX mi Service Required (yellow display message) | <ul style="list-style-type: none"> <li>* A malfunction has occurred in the high-voltage battery. It will no longer be possible to start the electric drive system after the distance displayed has been covered.                             <ul style="list-style-type: none"> <li>► Have the necessary maintenance work on the high-voltage battery carried out at a qualified specialist workshop.</li> </ul> </li> </ul>             |
| High-voltage Battery Fault No Start in Approx. XXX mi Service Required (red display message)    | <ul style="list-style-type: none"> <li>* A malfunction has occurred in the high-voltage battery. It will no longer be possible to start the electric drive system after the distance displayed has been covered.                             <ul style="list-style-type: none"> <li>► Have the necessary maintenance work on the high-voltage battery carried out immediately at a qualified specialist workshop.</li> </ul> </li> </ul> |
| High-Voltage Battery Fault Service Required Do Not Restart the Vehicle                          | <ul style="list-style-type: none"> <li>* A malfunction has occurred in the high-voltage battery. It will no longer be possible to restart the drive system once it has been switched off.                             <ul style="list-style-type: none"> <li>► Without switching off the drive system, drive on to the nearest qualified specialist workshop.</li> </ul> </li> </ul>   |



## Brakes





| Display messages   | Possible causes/consequences and ► Solutions  |
|--|---|
| Check Brake Pads See Operator's Manual   | <ul style="list-style-type: none"> <li>* The brakepads have reached their wear limit.                             <div style="border: 1px solid black; padding: 5px; margin-top: 10px;"> <p><b>⚠ WARNING</b> Risk of accident due to restricted braking power</p> <p>When the brake pads have reached their wear limit, the braking power may be restricted.</p> <ul style="list-style-type: none"> <li>► Drive on carefully.</li> <li>► Have the brake system checked immediately at a qualified specialist workshop.</li> </ul> </div> <ul style="list-style-type: none"> <li>► Consult a qualified specialist workshop.</li> </ul> </li> </ul>   |
| <br>Check Brake Fluid Level | <ul style="list-style-type: none"> <li>* There is insufficient brake fluid in the brake fluid reservoir.                             <div style="border: 1px solid black; padding: 5px; margin-top: 10px;"> <p><b>⚠ WARNING</b> Risk of an accident due to low brake fluid level</p> <p>If the brake fluid level is too low, the braking effect and the braking characteristics may be impaired.</p> <ul style="list-style-type: none"> <li>► Pull over and stop the vehicle safely as soon as possible, paying attention to road and traffic conditions. Do not continue driving under any circumstances.</li> <li>► Consult a qualified specialist workshop.</li> <li>► Do not add brake fluid.</li> </ul> </div> </li> </ul> |

| Display messages   | Possible causes/consequences and ► Solutions   |
|--|--|
|  <p data-bbox="207 413 422 485">To Release the Parking Brake: Switch On the Vehicle</p> | <ul style="list-style-type: none"> <li>► Stop the vehicle immediately in accordance with the traffic conditions. Do not continue driving!</li> </ul> <p>* The red  indicator lamp is lit.</p> <p>You have attempted to release the electric parking brake with the vehicle switched off.</p> <ul style="list-style-type: none"> <li>► Switch on the vehicle.</li> </ul>   |
|  <p data-bbox="207 605 435 650">Parking Brake See Operator's Manual</p>                 | <p>* The yellow  indicator lamp is lit. The electric parking brake is malfunctioning.</p> <p><b>To apply:</b></p> <ul style="list-style-type: none"> <li>► Switch the vehicle off and back on again.</li> <li>► Apply the electric parking brake manually (→ page 118).</li> </ul> <p>If it is not possible to apply the electric parking brake:</p> <ul style="list-style-type: none"> <li>► Consult a qualified specialist workshop.</li> <li>► Where necessary, also secure the parked vehicle against rolling away.</li> </ul> <p>* The yellow  and red  indicator lamps are lit. The electric parking brake is malfunctioning.</p> <p><b>To release:</b></p> <ul style="list-style-type: none"> <li>► Switch the vehicle off and back on again.</li> <li>► Release the electric parking brake manually (→ page 118).</li> </ul> <p>or</p> <ul style="list-style-type: none"> <li>► Release the electric parking brake automatically (→ page 118).</li> </ul> <p>If it is still not possible to release the electric parking brake:</p> <ul style="list-style-type: none"> <li>► Do not continue driving! Contact a qualified specialist workshop.</li> </ul> <p>* The yellow  indicator lamp is lit, and the red  indicator lamp is flashing. The electric parking brake is malfunctioning.</p> <p>The electric parking brake could not be applied or released.</p> <ul style="list-style-type: none"> <li>► Switch the vehicle off and back on again.</li> </ul> <p><b>To apply:</b></p> <ul style="list-style-type: none"> <li>► Release and then apply the electric parking brake manually (→ page 118).</li> </ul> <p><b>To release:</b></p> <ul style="list-style-type: none"> <li>► Apply and then release the electric parking brake manually.</li> </ul> <p>If it is not possible to apply the electric parking brake or the red  indicator lamp continues to flash:</p> <ul style="list-style-type: none"> <li>► Do not continue driving! Contact a qualified specialist workshop.</li> <li>► Where necessary, also secure the parked vehicle against rolling away.</li> </ul> |

| Display messages  | Possible causes/consequences and ► Solutions   |
|---|--|
|   | <p>* The yellow  indicator lamp is lit, and the red  indicator lamp flashes for approximately ten seconds after the electric parking brake has been applied or released. It then remains lit or goes out. The electric parking brake is malfunctioning.</p> <p><b>If the state of charge is too low:</b></p> <ul style="list-style-type: none"> <li>► Charge the 12 V battery (→ page 181).</li> </ul> <p><b>To apply:</b></p> <ul style="list-style-type: none"> <li>► Switch off the vehicle.<br/>The electric parking brake will be applied automatically.</li> <li>► Apply the electric parking brake manually.</li> </ul> <p>If you do not want the electric parking brake to be applied, e.g. at an automatic car wash or when the vehicle is being towed, leave the vehicle switched on. This does not include having the vehicle towed with the rear axle raised.</p> <p>If the electric parking brake is not applied automatically:</p> <ul style="list-style-type: none"> <li>► Switch the vehicle off and back on again.</li> <li>► Release and then apply the electric parking brake manually (→ page 118).</li> </ul> <p>If it is not possible to apply the electric parking brake:</p> <ul style="list-style-type: none"> <li>► Consult a qualified specialist workshop.</li> <li>► Where necessary, also secure the parked vehicle against rolling away.</li> </ul> <p><b>To release:</b></p> <ul style="list-style-type: none"> <li>► If the conditions for automatic release are fulfilled and the electric parking brake is not released automatically, release the electric parking brake manually (→ page 118).</li> </ul> <p>If it is still not possible to release the electric parking brake:</p> <ul style="list-style-type: none"> <li>► Do not continue driving! Contact a qualified specialist workshop.</li> </ul> |
| <div style="border: 1px solid black; padding: 5px; display: inline-block; text-align: center;">  </div> <p>Incline Too Steep See Operator's Manual</p> | <p>* The on-board electrical system voltage is low or a malfunction has occurred in the system; the holding force may not be sufficient for the incline.</p> <div style="border: 1px solid gray; padding: 5px; margin-top: 10px;"> <p><b>▲ WARNING</b> Risk of accident if the electrical parking brake has insufficient holding force</p> <p>If the electrical parking brake does not have sufficient holding force on a steep incline, the vehicle may roll away.</p> <ul style="list-style-type: none"> <li>► Park the vehicle on a level surface only and secure it against rolling away.</li> <li>► Shift the automatic transmission to position .</li> </ul> </div> <p>Observe the notes on parking the vehicle (→ page 116).</p>   |

## Tires

| Display messages             | Possible causes/consequences and ► Solutions   |
|------------------------------|--|
| Please Correct Tire Pressure | <p>* The yellow  warning lamp also lights up.</p> <p>The tire pressure is too low in at least one tire, or the difference in tire pressure between the individual wheels is too great.</p> <p>The wheel position will be shown.</p> <ul style="list-style-type: none"> <li>► Check the tire pressures at the next opportunity (→ page 193).</li> <li>► Correct the tire pressures as necessary.</li> <li>► Restart the tire pressure monitor (→ page 194).</li> </ul>   |
| Check Tires                  | <p>* A warning tone will sound, and the yellow  warning lamp will light up.</p> <p>The pressure in one or more tires has dropped significantly.</p> <p>The wheel position will be shown.</p> <div style="border: 1px solid gray; padding: 5px; margin: 10px 0;"> <p><b>▲ WARNING</b> Risk of an accident due to insufficient tire pressure</p> <ul style="list-style-type: none"> <li>• The tires can burst.</li> <li>• The tires can wear excessively and/or unevenly.</li> <li>• The driving characteristics as well as the steering and braking may be greatly impaired.</li> </ul> <p>You could then lose control of the vehicle.</p> <ul style="list-style-type: none"> <li>► Observe the recommended tire pressures.</li> <li>► Adjust the tire pressure if necessary.</li> </ul> </div> <ul style="list-style-type: none"> <li>► Stop the vehicle without steering or braking suddenly. Pay attention to the traffic conditions.</li> <li>► Secure the vehicle against rolling away.</li> <li>► Check the tires. If necessary, replace the wheel (→ page 204).</li> <li>► Check the tire pressures (→ page 193). Correct the tire pressures as necessary.</li> </ul> |
| Warning Tire Fault           | <p>* The yellow  warning lamp also lights up.</p> <p>The tire pressure in one or more tires has dropped suddenly.</p> <p>The wheel position is shown.</p> <div style="border: 1px solid gray; padding: 5px; margin: 10px 0;"> <p><b>▲ WARNING</b> Risk of an accident from driving with a flat tire</p> <ul style="list-style-type: none"> <li>• The tires can overheat and cause a fire.</li> <li>• The driving characteristics as well as the steering and braking may be greatly impaired.</li> </ul> <p>You could then lose control of the vehicle.</p> <ul style="list-style-type: none"> <li>► Do not drive on with a flat tire.</li> <li>► Observe the notes on flat tires.</li> </ul> </div> <ul style="list-style-type: none"> <li>► Stop the vehicle without steering or braking suddenly. Pay attention to the traffic conditions.</li> <li>► Secure the vehicle against rolling away.</li> </ul>  |



| Display messages  | Possible causes/consequences and ► Solutions  |
|---|---|
|   | <ul style="list-style-type: none"> <li>► Check the tires. If necessary, replace the wheel (→ page 204).</li> </ul>  |
| Tire Press. Monitoring System Currently Unavailable                       | <ul style="list-style-type: none"> <li>* The yellow  warning lamp will flash for about one minute and will then light up continuously.<br/>Due to a source of radio interference, no signals from the tire pressure sensor are being received. The tire pressure monitoring system is temporarily malfunctioning.<br/>The tire pressure monitoring system will restart automatically as soon as the cause has been rectified.</li> </ul> |
| Tire Pressure Sensors Missing   | <ul style="list-style-type: none"> <li>* The yellow  warning lamp will flash for about one minute and will then light up continuously.<br/>There is no signal from the tire pressure sensor of at least one tire. The display is not showing any pressure value for the tire in question.</li> <li>► Have the faulty tire pressure sensor replaced at a qualified specialist workshop.</li> </ul>  |
| Tire Pressure Monitoring System Inoperative Tire Pressure Sensors Missing | <ul style="list-style-type: none"> <li>* The yellow  warning lamp will flash for about one minute and will then light up continuously.<br/>The wheels installed do not have suitable tire pressure sensor. The tire pressure monitoring system is deactivated.</li> <li>► Install wheels with suitable tire pressure sensor.<br/>The tire pressure monitoring system will switch on after a few minutes of driving.</li> </ul>           |
| Tire Pressure Monitoring System Inoperative                               | <ul style="list-style-type: none"> <li>* The yellow  warning lamp will flash for about one minute and will then light up continuously.<br/>The tire pressure monitoring system is malfunctioning.</li> <li>► Consult a qualified specialist workshop.</li> </ul>   |

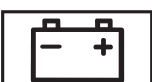

## Battery

| Display messages  | Possible causes/consequences and ► Solutions  |
|---|---|
|  <p>Stop Vehicle See Operator's Manual</p> | <ul style="list-style-type: none"> <li>* The 12 V battery is no longer being charged and the state of charge is too low.</li> </ul> <div style="border: 1px solid gray; padding: 5px; margin-top: 10px;"> <p><b>!</b> <b>NOTE</b> Possible damage to the drive system if you continue driving</p> <ul style="list-style-type: none"> <li>► Do not continue driving.</li> <li>► Consult a qualified specialist workshop.</li> </ul> </div> <ul style="list-style-type: none"> <li>► Stop the vehicle immediately in accordance with the traffic conditions. Do not continue driving!</li> <li>► Switch off the vehicle.</li> <li>► Contact a qualified specialist workshop.</li> </ul> |



| Display messages   | Possible causes/consequences and ► Solutions   |
|--|--|
|  <p>Stop Vehicle To Charge the 12 V Battery Do Not Switch Off Vehicle</p> | <ul style="list-style-type: none"> <li>* The state of charge of the 12 V battery is too low. <ul style="list-style-type: none"> <li>► Stop the vehicle immediately in accordance with the traffic conditions. Do not continue driving!</li> <li>► Leave the vehicle running.</li> <li>► If the display message disappears: drive on.</li> <li>► If the display message does not disappear: consult a qualified specialist workshop.</li> </ul> </li> </ul>   |
|  <p>12 V Battery See Operator's Manual</p>                                | <ul style="list-style-type: none"> <li>* The drive system is off and the charge level of the 12 V battery is too low. <ul style="list-style-type: none"> <li>► Switch off electrical consumers that are not required.</li> <li>► Drive for 30–60 mins.</li> </ul> </li> <li>or</li> <li>► Charge the vehicle at a charging station (→ page 107).</li> </ul> <p>If the message appears while the vehicle is switched on, this indicates an on-board electrical system malfunction.</p> <ul style="list-style-type: none"> <li>► Consult a qualified specialist workshop.</li> </ul> |



### Key

| Display messages  | Possible causes/consequences and ► Solutions   |
|---|--|
| <p>Place Key in the Marked Space See Operator's Manual</p>  | <ul style="list-style-type: none"> <li>* Key detection is malfunctioning. <ul style="list-style-type: none"> <li>► Change the key's position in the vehicle.</li> <li>► Place the key in the slot for starting with the key (→ page 98).</li> </ul> </li> </ul>  |
|  <p>Replace Key Battery</p>                       | <ul style="list-style-type: none"> <li>* The key battery is flat. <ul style="list-style-type: none"> <li>► Replace the battery (→ page 40).</li> </ul> </li> </ul>   |
|  <p>Key Not Detected (white display message)</p> | <ul style="list-style-type: none"> <li>* The key is currently not detected. <ul style="list-style-type: none"> <li>► Change the key's position in the vehicle.</li> <li>► Try to start the vehicle.</li> <li>► If the key is still not detected, place it in the slot for starting with the key (→ page 98).</li> <li>► Start the vehicle.</li> </ul> </li> </ul>  |
|  <p>Key Not Detected (red display message)</p>   | <ul style="list-style-type: none"> <li>* The key can no longer be detected during a journey and may no longer be in the vehicle.</li> </ul> <p>If the key is no longer in the vehicle and you switch off the vehicle:</p> <ul style="list-style-type: none"> <li>• You can no longer start the vehicle.</li> <li>• You cannot centrally lock the vehicle.</li> </ul> <ul style="list-style-type: none"> <li>► Ensure that the key is in the vehicle.</li> </ul> <p>If the key is in the vehicle and is still not detected:</p> |

| Display messages  | Possible causes/consequences and ► Solutions  |
|---|---|
|   | <ul style="list-style-type: none"> <li>► Stop the vehicle immediately in accordance with the traffic conditions.</li> <li>► Place the key in the slot for starting with the key (→ page 98).</li> </ul> <p>The key battery is weak or flat.</p> <ul style="list-style-type: none"> <li>► Check the battery using the indicator lamp (→ page 39).</li> <li>► Replace the key battery, if necessary (→ page 40).</li> </ul> |
|  <p>Key Not Detected Place Key Back into Driver's Area (white display message)</p> | <ul style="list-style-type: none"> <li>* The key is not in the driver's area of the vehicle (→ page 39).</li> <li>► Change the key's position in the vehicle.</li> <li>► If necessary, stop the vehicle immediately in accordance with the traffic conditions.</li> <li>► Start the vehicle with the key in the marked space (→ page 98).</li> </ul>  |
|  <p>Key Not Detected Place Key Back into Driver's Area (red display message)</p>   | <ul style="list-style-type: none"> <li>* The key is not in the driver's area of the vehicle (→ page 39).</li> <li>► Change the key's position in the vehicle.</li> <li>► If necessary, stop the vehicle immediately in accordance with the traffic conditions.</li> <li>► Start the vehicle with the key in the marked space (→ page 98).</li> </ul>  |
|  <p>Replace Key</p>  | <ul style="list-style-type: none"> <li>* Have the key replaced.</li> <li>► Consult a qualified specialist workshop.</li> </ul>  |





Vehicle

| Display messages  | Possible causes/consequences and ► Solutions   |
|---|--|
|  | <ul style="list-style-type: none"> <li>* A warning tone also sounds. The hood is open.</li> </ul> <div style="border: 1px solid gray; padding: 5px; margin: 5px 0;"> <p><b>⚠ WARNING</b> Risk of accident due to driving with the hood unlocked</p> <p>The hood may open and block your view.</p> <ul style="list-style-type: none"> <li>► Never release the hood when driving.</li> <li>► Before every trip, ensure that the hood is locked.</li> </ul> </div> <ul style="list-style-type: none"> <li>► Stop the vehicle immediately in accordance with the traffic conditions.</li> <li>► Secure the vehicle against rolling away.</li> <li>► Close the hood.</li> </ul> |
|  | <ul style="list-style-type: none"> <li>* At least one door is open.</li> </ul> <p>In addition, a warning tone sounds while the vehicle is in motion. The display shows the open door or doors.</p>   |

| Display messages  | Possible causes/consequences and ► Solutions  |
|---|---|
|  <p>Refill Washer Fluid</p>  | <ul style="list-style-type: none"> <li>► Close all the doors.</li> </ul> <p>* The washer fluid level in the washer fluid reservoir has dropped below the minimum.</p> <ul style="list-style-type: none"> <li>► Add washer fluid (→ page 171).</li> </ul>  |
|  <p>Steering Fault Stop<br/>Immediately See Operator's Manual</p>      | <p>* The steering is malfunctioning. Steerability is heavily impaired.</p> <div style="border: 1px solid gray; padding: 5px; margin-top: 10px;"> <p><b>▲ WARNING</b> Risk of accident if steering capability is impaired</p> <p>If the steering does not function as intended, the vehicle's operating safety is jeopardized.</p> <ul style="list-style-type: none"> <li>► Pull over and stop the vehicle safely as soon as possible, paying attention to road and traffic conditions. Do not continue driving under any circumstances.</li> <li>► Consult a qualified specialist workshop.</li> </ul> </div> |
|  <p>Steering Fault Increased Physical Effort See Operator's Manual</p> | <p>* The steering power assistance is malfunctioning.</p> <div style="border: 1px solid gray; padding: 5px; margin-top: 10px;"> <p><b>▲ WARNING</b> Risk of an accident due to altered steering characteristics</p> <p>If the power assistance of the steering fails partially or completely, you will need to use more force to steer.</p> <ul style="list-style-type: none"> <li>► If safe steering is possible, drive on carefully.</li> <li>► Visit or consult a qualified specialist workshop immediately.</li> </ul> </div>   |
| <p>Risk of Rolling Driver's Seat Not Occupied Drive Range P Not Selected</p>  | <p>* A warning tone also sounds. The driver's seat has been left and the transmission is in position <b>N</b>, <b>R</b> or <b>D</b>.</p> <ul style="list-style-type: none"> <li>► Shift the transmission to position <b>P</b>.</li> <li>► Secure the vehicle against rolling away.</li> </ul>   |
| <p>Shift to Drive Range P or N to Start Engine</p>  | <p>* You have attempted to start the vehicle in transmission position <b>R</b> or <b>D</b>.</p> <ul style="list-style-type: none"> <li>► Shift the transmission to position <b>P</b> or <b>N</b>.</li> </ul>  |
| <p>Apply Brake to Shift from Drive Range P</p>  | <p>* You have tried to shift the transmission to position <b>D</b>, <b>R</b> or <b>N</b> without applying the brake.</p> <ul style="list-style-type: none"> <li>► Depress the brake pedal.</li> </ul>   |
| <p>To Deselect Drive Range P or N Depress Brake and Start Vehicle</p>   | <p>* You have attempted to shift the transmission out of park position <b>P</b> or neutral <b>N</b> and into another transmission position.</p> <ul style="list-style-type: none"> <li>► Depress the brake pedal.</li> <li>► Start the vehicle.</li> <li>► Change the transmission position.</li> </ul>   |
| <p>To Engage Drive Range R First Depress the Brake</p>  | <p>* You have tried to shift the transmission to position <b>R</b> without applying the brake.</p> <ul style="list-style-type: none"> <li>► Depress the brake pedal.</li> <li>► Shift the transmission to position <b>R</b>.</li> </ul>   |

| Display messages   | Possible causes/consequences and ► Solutions  |
|--|---|
| <p><b>N Permanently Active:</b><br/>Risk of Rolling</p>              | <p>* A warning tone also sounds. While the vehicle is rolling or driving, the transmission was shifted to position <b>N</b>.</p> <ul style="list-style-type: none"> <li>► To stop, depress the brake pedal and, when the vehicle is at a standstill, shift the transmission to position <b>P</b>.</li> <li>► To continue your journey, shift the transmission to position <b>R</b> or <b>D</b>.</li> </ul>  |
| <p>Risk of Rolling Driver's Door Open Drive Range P Not Selected</p> | <p>* A warning tone also sounds. The driver's door is open and the transmission is in position <b>N</b>, <b>R</b> or <b>D</b>.</p> <ul style="list-style-type: none"> <li>► Shift the transmission to position <b>P</b>.</li> <li>► Secure the vehicle against rolling away.</li> </ul>   |
| <p>Do Not Change Drive Range Service Required</p>                    | <p>* A warning tone also sounds. You can no longer change the transmission position due to a malfunction.</p> <p>If transmission position <b>D</b> has been selected:</p> <ul style="list-style-type: none"> <li>► Without changing the transmission position, consult a qualified specialist workshop.</li> </ul> <p>If transmission position <b>P</b>, <b>R</b> or <b>N</b> has been selected:</p> <ul style="list-style-type: none"> <li>► Inform a qualified specialist workshop.</li> </ul>  |
| <p>Reversing Not Possible: Service Required</p>                      | <p>* The transmission is malfunctioning. Transmission position <b>R</b> cannot be selected.</p> <ul style="list-style-type: none"> <li>► Inform a qualified specialist workshop.</li> </ul>   |
| <p>Only Shift to Drive Range P when Vehicle is Stationary</p>        | <p>* The vehicle is still moving.</p> <ul style="list-style-type: none"> <li>► Stop in accordance with the traffic conditions.</li> <li>► Shift the transmission to position <b>P</b>.</li> </ul>   |
| <p>Transmission Fault Stop</p>                                       | <p>* The transmission is malfunctioning. The transmission automatically switches to neutral <b>N</b>.</p> <ul style="list-style-type: none"> <li>► Stop the vehicle immediately in accordance with the traffic conditions.</li> <li>► Shift the transmission to position <b>P</b>.</li> <li>► Inform a qualified specialist workshop.</li> </ul>  |
| <p>SOS NOT READY</p>   | <p>* The emergency call system is not available.</p> <p>Possible causes for this include:</p> <ul style="list-style-type: none"> <li>• The vehicle is switched off.</li> <li>• The emergency call system is malfunctioning.</li> </ul> <ul style="list-style-type: none"> <li>► Switch on the vehicle.</li> </ul> <p>If an emergency call is unavailable, a message to this effect will appear on the instrument cluster.</p> <ul style="list-style-type: none"> <li>► Consult a qualified specialist workshop.</li> </ul> <p>ⓘ You can find more information on the regional availability of the emergency call system at: <a href="http://www.mercedes-benz.com/connect_ecall">http://www.mercedes-benz.com/connect_ecall</a></p> |

## Lights







| Display messages  | Possible causes/consequences and ► Solutions  |
|---|---|
| <br>Low Beam Left (example)              | <ul style="list-style-type: none"> <li>* The corresponding light source is defective.<br/>Have defective LED lights replaced at a qualified specialist workshop.</li> <li>► Observe the notes on changing a bulb (→ page 76).</li> <li>► Replace the defective bulb at the front (→ page 76) or rear (→ page 77).</li> </ul>  |
| <br>Low Beam Left                        | <ul style="list-style-type: none"> <li>* The left low beam is malfunctioning.</li> <li>► Consult a qualified specialist workshop.</li> </ul>  |
| <br>Fault See Operator's Manual          | <ul style="list-style-type: none"> <li>* The exterior lighting is malfunctioning.</li> <li>► Consult a qualified specialist workshop.</li> </ul>  |
| <br>Automatic Driving Lights Inoperative | <ul style="list-style-type: none"> <li>* The light sensor is faulty. The automatic driving lights are malfunctioning.</li> <li>► Switch the light functions on/off manually (→ page 71).</li> <li>► Consult a qualified specialist workshop.</li> </ul>   |
| Adaptive Highbeam Assist Currently Unavailable See Operator's Manual  | <ul style="list-style-type: none"> <li>* Adaptive Highbeam Assist is deactivated and temporarily inoperative. The following causes are possible:               <ul style="list-style-type: none"> <li>• The windshield is dirty in the camera's field of vision.</li> <li>• Visibility is impaired due to heavy rain, snow or fog.</li> </ul> </li> <li>► Clean the windshield.<br/>When the system detects that the camera is fully operational, the display will show a message reading <b>Adaptive Highbeam Assist Available Again</b><br/>Adaptive Highbeam Assist will then be operational again.</li> </ul> |
| Adaptive Highbeam Assist Inoperative  | <ul style="list-style-type: none"> <li>* Adaptive Highbeam Assist is malfunctioning.</li> <li>► Switch high beam on/off manually.</li> <li>► Consult a qualified specialist workshop.</li> </ul>  |

















## Indicator and warning lamps

## Overview of indicator and warning lamps



Some systems will perform a self-test when the vehicle is switched on. Some indicator and warning lamps may briefly light up or flash. This behaviour is non-critical. These indicator and warning lamps indicate a malfunction only if they light up or flash after the vehicle has been started or during a journey.

## Indicator and warning lamps:

|   |                                |
|---|--------------------------------|
|  | Low beam (→ page 71)           |
|  | Side lights (→ page 71)        |
|  | High beam (→ page 72)          |
|  | Turn signal lights (→ page 72) |
|  | Fog light (→ page 71)          |
|  | Rear fog light (→ page 71)     |
|  | Seat belt not fastened         |



|   |     |                                     |
|---|-----|-------------------------------------|
|      | and | USA: Brakes (red) (→ page 276)      |
|      |     |                                     |
|      |     | Canada: Brakes (red) (→ page 276)   |
|      |     | Brakes (yellow) (→ page 276)        |
|      |     | ABS malfunction (→ page 276)        |
|      |     | ESP® (→ page 276)                   |
|      |     | ESP® OFF (→ page 276)               |
|      |     | Active Brake Assist switched off    |
|      |     | USA: Parking brake applied (red)    |
| and  |     | (→ page 276)                        |
|      |     | Canada: Parking brake applied (red) |
|   |     | (→ page 276)                        |
|      |     | Parking brake (yellow) (→ page 276) |
|      |     | Electric power steering malfunction |
|      |     | Electrical malfunction              |
|      |     | Restraint system                    |
|      |     | Distance warning (→ page 279)       |
|      |     | Tire pressure monitor (→ page 192)  |





Occupant safety

| Warning/indicator lamp  | Possible causes/consequences and ► Solutions  |
|---|---|
|  <p>Restraint system warning lamp</p>    | <p>*The red restraint system warning lamp is on while the vehicle is on. The restraint system is malfunctioning (→ page 28).</p> <div style="border: 1px solid gray; padding: 5px; margin: 5px 0;"> <p> <b>DANGER</b> Risk of death due to the restraint system malfunctioning</p> <p>Components in the restraint system may be activated unintentionally or not deploy as intended in an accident. In the event of an accident, the high-voltage on-board electrical system may not be deactivated as intended.</p> <p>You may receive an electric shock if you touch the damaged components of the high-voltage on-board electrical system.</p> <ul style="list-style-type: none"> <li>► Have the restraint system checked and repaired immediately at a qualified specialist workshop.</li> <li>► After an accident, switch off the vehicle immediately.</li> </ul> </div> <ul style="list-style-type: none"> <li>► Drive on carefully.</li> <li>► Note the messages on the instrument cluster.</li> <li>► Consult a qualified specialist workshop immediately.</li> </ul> |
|  <p>Seat belt warning lamp flashes</p> | <p>*The red seat belt warning lamp flashes, and an intermittent warning tone sounds.</p> <p>The driver or front passenger has not fastened their seat belt while the vehicle is in motion.</p> <ul style="list-style-type: none"> <li>► Fasten your seat belt (→ page 28).</li> <li>► The warning lamp and the intermittent warning tone will go out.</li> </ul>  |

| Warning/indicator lamp  | Possible causes/consequences and ► Solutions   |
|---|--|
|  <p data-bbox="207 349 414 403">Seat belt warning lamp lights up</p> | <p data-bbox="480 259 1125 313">*The red seat belt warning lamp lights up after the vehicle starts as soon as the driver's or front passenger door has been closed.</p> <p data-bbox="480 318 888 340">An intermittent warning tone may also sound.</p> <p data-bbox="480 349 1125 421">For certain countries only: The red seat belt warning lamp lights up for a maximum of six seconds after the vehicle has been switched on. The driver's or front passenger's seat belt is not fastened.</p> <ul style="list-style-type: none"> <li data-bbox="480 430 835 456">► Fasten your seat belt (→ page 28).</li> <li data-bbox="480 462 783 483">► The warning lamp will go out.</li> </ul> |



### Safety systems

| Warning/indicator lamp  | Possible causes/consequences and ► Solutions  |
|---|---|
|  <p data-bbox="207 707 381 761">ESP® warning lamp flashes</p>      | <p data-bbox="480 618 1125 698">*The yellow ESP® warning lamp flashes while the vehicle is in motion. ESP® or traction control intervenes because there is a risk of skidding or at least one wheel is spinning.</p> <p data-bbox="480 707 1125 761">Cruise control or Active Distance Assist DISTRONIC has been automatically switched off.</p> <ul style="list-style-type: none"> <li data-bbox="480 770 1059 797">► When pulling away, accelerate only as much as is necessary.</li> <li data-bbox="480 802 1013 829">► Depress the accelerator pedal less during your journey.</li> <li data-bbox="480 835 1092 861">► Adapt your driving style to suit the weather and road conditions.</li> <li data-bbox="480 867 730 894">► Do not switch off ESP®.</li> </ul> <p data-bbox="480 904 1125 931">In exceptional cases, it may be better to switch off ESP® (→ page 121).</p>  |
|  <p data-bbox="207 1039 434 1093">ESP® warning lamp lights up</p> | <p data-bbox="480 949 1125 1003">*The yellow ESP® warning lamp is on while the vehicle is on. ESP® is malfunctioning.</p> <p data-bbox="480 1012 1125 1066">Other driving systems and driving safety systems (e.g. BAS) may also be malfunctioning.</p> <div data-bbox="486 1084 1125 1263" style="border: 1px solid gray; padding: 5px;"> <p data-bbox="493 1089 1006 1116"><b>▲ WARNING</b> Risk of skidding if ESP® is malfunctioning</p> <p data-bbox="493 1128 1092 1182">If ESP® is malfunctioning, ESP® cannot carry out vehicle stabilization. In addition, other driving safety systems are switched off.</p> <ul style="list-style-type: none"> <li data-bbox="493 1191 697 1218">► Drive on carefully.</li> <li data-bbox="493 1223 1019 1250">► Have ESP® checked at a qualified specialist workshop.</li> </ul> </div> <ul style="list-style-type: none"> <li data-bbox="480 1272 861 1299">► Pay attention to the display messages.</li> <li data-bbox="480 1304 677 1331">► Drive on carefully.</li> <li data-bbox="480 1336 980 1363">► Consult a qualified specialist workshop immediately.</li> </ul> |
|  <p data-bbox="207 1469 421 1496">ESP® OFF warning lamp</p>      | <p data-bbox="480 1379 1125 1433">*The yellow ESP® OFF warning lamp is on while the vehicle is on. ESP® has been deactivated.</p> <div data-bbox="486 1451 1125 1576" style="border: 1px solid gray; padding: 5px;"> <p data-bbox="493 1456 1105 1483"><b>▲ WARNING</b> Risk of skidding when driving with ESP® deactivated</p> <p data-bbox="493 1496 1105 1550">ESP® does not act to stabilize the vehicle. The availability of further driving safety systems is also limited.</p> <ul style="list-style-type: none"> <li data-bbox="493 1559 697 1585">► Drive on carefully.</li> </ul> </div>  |



| Warning/indicator lamp   | Possible causes/consequences and ► Solutions   |
|--|--|
|  | <ul style="list-style-type: none"> <li>► Deactivate ESP® only for as long as the situation requires.</li> <li>If ESP® cannot be activated, ESP® is malfunctioning.</li> <li>► Have ESP® checked immediately at a qualified specialist workshop.</li> </ul> <p>► Switch ESP® on again.</p> <p>In exceptional cases, it may be better to switch off ESP® (→ page 121).</p> <p>► Adapt your driving style to suit the road and weather conditions.</p> <p>If ESP® cannot be switched on:</p> <ul style="list-style-type: none"> <li>► Drive on carefully.</li> <li>► Have ESP® checked at a qualified specialist workshop.</li> </ul>   |
|  <p>Parking brake indicator lamp (yellow)</p> | <p>*The yellow parking brake indicator lamp is flashing or lit up. The parking brake is malfunctioning.</p> <ul style="list-style-type: none"> <li>► Note the messages on the instrument cluster.</li> </ul>   |
|  <p>Parking brake indicator lamp (red)</p>    | <p>*The red parking brake indicator lamp is flashing or lit up.</p> <ul style="list-style-type: none"> <li>► Observe the notes on the manual parking brake or the electric parking brake (→ page 117).</li> </ul> <p>If the  yellow indicator lamp also lights up or flashes, the parking brake is malfunctioning.</p> <ul style="list-style-type: none"> <li>► Note the messages on the instrument cluster.</li> </ul>   |
|  <p>Brakes warning lamp (yellow)</p>        | <p>*The yellow brake warning lamp is lit while the vehicle is running.</p> <div style="border: 1px solid gray; padding: 5px; margin: 5px 0;"> <p><b>▲ WARNING</b> Risk of an accident due to a brake system malfunction</p> <p>If the brake system is malfunctioning, braking characteristics may be impaired.</p> <ul style="list-style-type: none"> <li>► Drive on carefully.</li> <li>► Have the brake system checked immediately at a qualified specialist workshop.</li> </ul> </div> <ul style="list-style-type: none"> <li>► Drive on carefully at an adjusted speed and at a sufficient distance from the vehicle in front.</li> <li>► If the instrument cluster shows a display message, observe it.</li> <li>► Consult a qualified specialist workshop.</li> </ul> |
|  <p>Brakes warning lamp (red)</p>           | <p>*The red brake system warning lamp is on while the vehicle is on.</p> <p>Possible causes:</p> <ul style="list-style-type: none"> <li>• The brake force boosting is malfunctioning and the braking characteristics may be affected.</li> <li>• There is insufficient brake fluid in the brake fluid reservoir.</li> </ul>  |

| Warning/indicator lamp   | Possible causes/consequences and ► Solutions   |
|--|--|
|  | <p><b>▲ WARNING</b> Risk of accident and injury if brake force boosting is malfunctioning</p> <p>If brake force boosting is malfunctioning, increased brake pedal force may be necessary for braking. The braking characteristics may be impaired. The braking distance can increase in emergency braking situations.</p> <ul style="list-style-type: none"> <li>► Stop in a safe location immediately. Do not continue driving.</li> <li>► Consult a qualified specialist workshop.</li> </ul> <p><b>▲ WARNING</b> Risk of an accident due to low brake fluid level</p> <p>If the brake fluid level is too low, the braking effect and the braking characteristics may be impaired.</p> <ul style="list-style-type: none"> <li>► Pull over and stop the vehicle safely as soon as possible, paying attention to road and traffic conditions. Do not continue driving under any circumstances.</li> <li>► Consult a qualified specialist workshop.</li> <li>► Do not add brake fluid.</li> </ul> <ul style="list-style-type: none"> <li>► Stop the vehicle immediately in accordance with the traffic conditions. Do not continue driving!</li> <li>► Secure the vehicle against rolling away.</li> <li>► Contact a qualified specialist workshop.</li> <li>► Do not add brake fluid.</li> </ul> |
|  <p>ABS warning lamp</p> | <p>*The yellow ABS warning lamp is on while the vehicle is on. ABS is malfunctioning.</p> <p>If an additional warning tone sounds, this means the EBD is malfunctioning.</p> <p>Other driving systems and driving safety systems may also be malfunctioning.</p> <ul style="list-style-type: none"> <li>► Note the messages on the instrument cluster.</li> </ul> <p><b>▲ WARNING</b> There is a risk of skidding if EBD or ABS is malfunctioning</p> <p>The wheels may lock during braking.</p> <p>The steerability and braking characteristics are heavily impaired and the braking distance may increase. In addition, other driving safety systems are switched off.</p> <ul style="list-style-type: none"> <li>► Drive on carefully.</li> <li>► Have the brake system checked immediately at a qualified specialist workshop.</li> </ul>  |





Driving and driving safety systems

| Warning/indicator lamp  | Possible causes/consequences and ► Solutions  |
|---|---|
|  <p data-bbox="185 390 389 413">Distance warning lamp</p>            | <p data-bbox="452 301 1089 408">*The red distance warning lamp lights up while the vehicle is in motion. The distance to the vehicle in front is too small for the selected speed. If an additional warning tone sounds, this means you are approaching an obstacle at too high a speed.</p> <ul style="list-style-type: none"> <li data-bbox="461 417 869 444">► Be ready to apply the brakes immediately.</li> <li data-bbox="461 449 694 476">► Increase the distance.</li> </ul> <p data-bbox="461 489 879 516">Function of Active Brake Assist (→ page 123).</p> |
|  <p data-bbox="185 618 413 670">Active Brake Assist warning lamp</p> | <p data-bbox="452 528 1100 605">*The Active Brake Assist warning lamp is on. Due to dirty sensors or a malfunction, the system is not available or the range of functions is restricted.</p> <ul style="list-style-type: none"> <li data-bbox="461 614 905 641">► Note the messages on the instrument cluster.</li> </ul>   |

Vehicle

| Warning/indicator lamp  | Possible causes/consequences and ► Solutions   |
|---|--|
|  <p data-bbox="185 896 413 922">Tachograph warning lamp</p>              | <p data-bbox="452 806 1083 883">*The yellow tachograph indicator lamp is lit. The tachograph (TCO) has malfunctioned, e.g. due to invalid data or a missing driver card.</p> <p data-bbox="461 892 1067 942">Possible causes of malfunctions can be found in the manufacturer's Operator's Manual.</p>   |
|  <p data-bbox="185 1044 396 1096">Power steering warning lamp (red)</p> | <p data-bbox="452 955 1050 1007">*The red power steering warning lamp is on while the vehicle is on. The power assistance or the steering itself is malfunctioning.</p> <div data-bbox="461 1023 1102 1243" style="border: 1px solid gray; padding: 5px;"> <p data-bbox="475 1030 1050 1057"><b>▲ WARNING</b> Risk of accident if steering capability is impaired</p> <p data-bbox="475 1066 1089 1118">If the steering does not function as intended, the vehicle's operating safety is jeopardized.</p> <ul style="list-style-type: none"> <li data-bbox="484 1127 1063 1202">► Pull over and stop the vehicle safely as soon as possible, paying attention to road and traffic conditions. Do not continue driving under any circumstances.</li> <li data-bbox="484 1211 865 1238">► Consult a qualified specialist workshop.</li> </ul> </div> <ul style="list-style-type: none"> <li data-bbox="461 1259 1083 1311">► Stop the vehicle immediately in accordance with the traffic conditions. Do not continue driving!</li> <li data-bbox="461 1320 852 1347">► Contact a qualified specialist workshop.</li> <li data-bbox="461 1356 905 1383">► Note the messages on the instrument cluster.</li> </ul> |
|  <p data-bbox="185 1483 363 1510">Door indicator lamp</p>              | <p data-bbox="452 1394 850 1446">*The yellow "door open" indicator lamp is lit. A door is not fully closed</p> <ul style="list-style-type: none"> <li data-bbox="461 1455 672 1481">► Close all the doors.</li> </ul>  |

## Drive system

| Warning/indicator lamp  | Possible causes/consequences and ► Solutions  |
|---|---|
|  <p>Reduced warning lamp power</p>           | <p>* The yellow reduced power warning lamp is lit. Drive system power output is reduced.</p> <p>► Note the messages on the instrument cluster.</p>  |
|  <p>High-voltage battery reserve</p>         | <p>* The yellow warning lamp for the charge level of the high-voltage battery is lit. The state of charge of the high-voltage battery has reached the reserve level.</p> <p>► Charge the high-voltage battery.</p>                              |
|  <p>High-voltage battery warning</p>         | <p>* The red warning lamp lights up while the drive system is on. There is a malfunction in the drive system.</p> <p>or</p> <p>The high-voltage battery's state of charge is too low.</p> <p>► Note the messages on the instrument cluster.</p> |
|  <p>System malfunction warning lamp</p>      | <p>* The red system error warning lamp is lit while the vehicle is in a state of operational readiness [READY]. There is a malfunction in the drive system.</p> <p>► Note the messages on the instrument cluster.</p>                           |
|  <p>Electrical malfunction warning lamp</p> | <p>* The red electrical malfunction warning lamp is lit. There is a malfunction with the electrics.</p> <p>► Note the messages on the instrument cluster..</p>  |

## Tires

| Warning/indicator lamp  | Possible causes/consequences and ► Solutions   |
|---|--|
|  <p>Tire pressure monitoring system warning lamp flashes</p> | <p>* The yellow tire pressure monitoring system warning lamp (pressure loss/malfunction) flashes for approximately one minute and then remains lit. The tire pressure monitoring system is malfunctioning.</p> <div style="border: 1px solid black; padding: 5px; margin-top: 10px;"> <p><b>⚠ WARNING</b> There is a risk of an accident if the tire pressure monitoring system is malfunctioning</p> <p>The tire pressure monitoring system cannot issue a warning if there is pressure loss in one or more of the tires.</p> <p>Tires with insufficient tire pressure may impair the driving characteristics as well as steering and braking.</p> <p>► Have the tire pressure monitoring system checked at a qualified specialist workshop.</p> </div> <p>► Pay attention to the display messages.</p> |

| Warning/indicator lamp  | Possible causes/consequences and ► Solutions   |
|---|--|
| <div data-bbox="194 301 347 383" data-label="Image"> </div> <p data-bbox="185 390 405 464">Tire pressure monitoring system warning lamp lights up</p> | <p data-bbox="464 258 850 283">► Consult a qualified specialist workshop.</p> <p data-bbox="455 297 1090 397">*The yellow tire pressure monitoring system warning lamp (pressure loss/malfunction) is on.<br/>The tire pressure monitoring system has detected a loss of pressure in at least one tire.</p> <div data-bbox="464 413 1102 691" data-label="Complex-Block" style="border: 1px solid gray; padding: 5px;"> <p data-bbox="475 421 1071 449"><b>▲ WARNING</b> Risk of an accident due to insufficient tire pressure</p> <ul data-bbox="488 462 1064 577" style="list-style-type: none"> <li>• The tires can burst.</li> <li>• The tires can wear excessively and/or unevenly.</li> <li>• The driving characteristics as well as the steering and braking may be greatly impaired.</li> </ul> <p data-bbox="481 593 854 618">You could then lose control of the vehicle.</p> <ul data-bbox="481 625 892 684" style="list-style-type: none"> <li>► Observe the recommended tire pressures.</li> <li>► Adjust the tire pressure if necessary.</li> </ul> </div> <p data-bbox="464 707 1100 758">► Stop the vehicle without steering or braking suddenly. Pay attention to the traffic conditions.</p> <p data-bbox="464 766 847 792">► Secure the vehicle against rolling away.</p> <p data-bbox="464 801 839 826">► Pay attention to the display messages.</p> <p data-bbox="464 835 1100 860">► Check the tires and, if necessary, replace the wheel (→ page 204).</p> <p data-bbox="464 869 713 894">► Check the tire pressure.</p> <p data-bbox="464 915 1010 940">You can check the tire pressure electronically (→ page 193).</p> <p data-bbox="464 949 844 974">► Correct the tire pressure as necessary.</p> |

|   |   |
|---|---|
| <b>1, 2, 3 ...</b>  |   |
| <b>3-zone automatic climate control (control panel)</b> .....   | 87  |
| <b>A</b>  |   |
| <b>A/C function</b> .....   | 88  |
| <b>ABS</b> .....  | 120   |
| <b>Accident and Breakdown Management</b><br>Mercedes me connect.....  | 153   |
| <b>Acoustic presence indicator</b> .....  | 94  |
| <b>Active Brake Assist</b><br>Function.....<br>Setting.....   | 123<br>125  |
| <b>Active Distance Assist DISTRONIC</b><br>Activating/deactivating.....<br>Calling up a speed.....<br>Function.....<br>Increasing/decreasing the speed.....<br>Storing a speed.....   | 128<br>128<br>126<br>128<br>128   |
| <b>Active Lane Keeping Assist</b><br>Activating/deactivating.....<br>Function.....<br>Trailer operation.....  | 137<br>136<br>136   |
| <b>Adaptive Highbeam Assist</b><br>Function.....<br>Switching on/off.....   | 74<br>74  |
| <b>Adding fluid to the windshield washer system</b> .....   | 171   |
| <b>Adjusting the lights (driving abroad)</b> .....  | 71  |
| <b>Adjusting the volume (audio system)</b> .....  | 156   |
| <b>Air bag</b><br>Inflating.....<br>Overview.....<br>Warning lamp.....  | 29<br>33<br>28  |
| <b>Air vents</b><br>Adjusting (front).....  | 90  |
| <b>Air-recirculation mode</b> .....   | 89  |
| <b>Alarm system</b> .....   | 54  |
| <b>Animals</b> .....  | 31  |
| <b>Anti-lock braking system</b> .....   | 120   |
| <b>Anti-skid chain</b> .....  | 189   |
| <b>Anti-theft alarm system</b><br>Activating/deactivating.....<br>Activating/deactivating interior protection.....<br>Function.....<br>Interior motion sensor.....<br>Stopping the alarm.....   | 55<br>56<br>54<br>56<br>55  |
| Switching the tow-away alarm on/off....   | 55  |
| Tow-away alarm.....   | 55  |
| <b>Anti-theft protection</b><br>Immobilizer.....  | 54  |
| <b>Apps, Digital Extras</b><br>Mercedes-Benz Connect.....   | 153   |
| <b>Ashtray</b> .....  | 68  |
| <b>ASR (acceleration skid control)</b> .....  | 121   |
| <b>Assistance system</b> .....  | 120   |
| <b>Assistant display (on-board computer)</b> .....  | 147   |
| <b>ASSYST PLUS, After-sales service center, Service, Service interval display, Vehicle maintenance</b><br>Battery disconnection periods.....<br>Displaying the service due date.....<br>Function/notes.....<br>Regular maintenance work.....<br>Special service requirements.....   | 166<br>166<br>166<br>166<br>166   |
| <b>Attachments</b> .....  | 14  |
| <b>ATTENTION ASSIST</b><br>Function.....<br>Switching on/off.....   | 131<br>132  |
| <b>Attention assistant</b> .....  | 131   |
| <b>Audio settings (audio system)</b><br>Balance/fader.....<br>Equalizer.....<br>Playback options.....<br>Resetting.....   | 157<br>157<br>159<br>157  |
| <b>Audio system</b><br>Activating/deactivating.....<br>Adjusting the volume.....<br>Bluetooth® audio device playback.....<br>Controls playback.....<br>iPod® playback.....<br>Notes.....<br>Operating unit.....<br>Overview.....<br>Resetting.....<br>Setting the time.....<br>Showing the software version.....<br>Switching on visibility.....<br>USB playback..... | 156<br>156<br>158<br>159<br>159<br>155<br>156<br>156<br>157<br>157<br>157<br>160<br>158 |
| <b>Authorised workshop</b> .....  | 19  |
| <b>Automatic climate control</b> .....  | 89  |
| <b>Automatic distance control</b> .....   | 126   |
| <b>Automatic driving lights</b> .....   | 71  |
| <b>Automatic locking</b><br>after closing the last door.....  | 43  |
| <b>Automatic measures after an accident</b> .....   | 29  |

- Automatic transmission**
  - DIRECT SELECT lever..... 105
  - Transmission position display..... 105
  - Transmission positions..... 105
- Available power display**..... 146
- Axle load**..... 241
- B**
- Back support**, Lumbar support..... 62
- Backing up lamp**
  - Replacing light sources..... 78
- BAS**..... 121
- Basic information**..... 26
- Battery**, 12 V battery, Vehicle battery
  - Charging..... 181
  - Charging the 12 V battery of the on-board electrical system..... 181
  - Disconnecting the auxiliary battery (front passenger seat)..... 181
  - High-voltage battery..... 180
  - Jump-starting (vehicle)..... 181
  - Key..... 40
  - Notes (vehicle battery)..... 179
  - Replacing the 12 V on-board electrical system battery..... 181
- Battery calibration**
  - Menu (on-board computer)..... 150
- Belt**
  - Adjusting the height..... 28
  - Fastening..... 28
  - Notes on wearing correctly..... 27
  - Unfastening..... 33
- Blind Spot Assist**
  - Exit warning..... 132
  - Function..... 132
  - Switching on/off..... 133
- Bluetooth®**
  - Connecting a mobile phone..... 160
- Bluetooth® (audio system)**
  - Activating/deactivating..... 160
- Bluetooth® audio device (audio system)**
  - Starting playback..... 158
- Bodies (body/equipment mounting directives)**..... 14
- Bottle holder**..... 68
- Brake**
  - ABS (anti-lock braking system)..... 120
  - Activating/deactivating the HOLD function..... 130
  - Active Brake Assist..... 123
  - BAS (Brake Assist System)..... 121
  - Braking with parking brake..... 100
  - Breaking-in notes..... 98
  - Downhill gradient..... 100
  - Driving instructions..... 98, 100
  - EBD (Electronic Brakeforce Distribution)..... 122
  - Heavy/light loads..... 100
  - HOLD function..... 129
  - Limited braking effect (salt-treated roads)..... 100
  - New brake disks/brake linings..... 100
  - new brake linings/brake disks..... 98
  - Post-collision brake..... 29
  - Recuperation..... 95
  - Wet road surfaces..... 100
- Brake Assist System**..... 121
- Brake fluid**..... 244
- Brakeforce Distribution**..... 122
- Braking assistance**..... 121
- Breakdown**
  - Changing a wheel..... 204
  - Overview of assistance..... 12
  - Roadside Assistance..... 15
  - Tow-starting..... 184
  - Towing (raised rear axle)..... 183
  - Towing methods..... 182
  - Transporting the vehicle..... 183
- Breaking-in notes**..... 98
- Bulbs**..... 76
- C**
- Calibration**
  - Automatically calibrating the high-voltage battery..... 167
  - High-voltage battery (on-board computer menu)..... 150
  - Manually calibrating the high-voltage battery..... 168
  - Notes on calibrating the high-voltage battery..... 166, 168
- Call list**
  - Making a call..... 161
- Calls**, Telephone operation
  - Accepting..... 160
  - Activating functions during a call..... 161
  - Declining..... 160
  - Ending a call..... 160
  - Incoming call during an existing call.... 161
  - Making..... 160
  - Telephone..... 160
  - Via the overhead control panel..... 151

- Cameras**
- Information..... 119
- Car key**..... 39
- Car wash (care)**..... 172
- Care**
- Car wash..... 172
- Carpet..... 174
- Display..... 174
- Exterior lighting..... 173
- Genuine wood/trim elements..... 174
- Headliner..... 174
- Plastic trim..... 174
- Power washer..... 172
- Reversing camera..... 173
- Seat belt..... 174
- Seat cover..... 174
- Sensors..... 173
- Trailer hitch..... 173
- Washing by hand..... 172
- Wheels/rims..... 173
- Windows..... 173
- Wiper blades..... 173
- Cargo compartment lamp (motion detector)**..... 75
- Cargo compartment ventilation**..... 91
- Cargo tie-down point**..... 249
- Cargo tie-down points**
- Overview..... 164
- Cargo tie-down rings**
- Loads..... 249
- Carpet**
- Clean..... 174
- Central locking system**
- Button..... 42
- Change of address**..... 16
- Change of ownership**..... 16
- Changing a wheel**
- Installing a new wheel..... 206
- Lowering the vehicle..... 207
- Preparing..... 204
- Raising the vehicle..... 204
- Removing a wheel..... 206
- Changing bulbs**
- High beam..... 77
- Indicator (front)..... 77
- Low beam..... 77
- Characteristics of the tire**..... 199
- Charge level display**..... 108, 146
- Charge level/charge display**..... 108
- Charging**
- At departure time..... 109
- Battery..... 181
- Charge level display..... 108
- Charging cable plug emergency release..... 115
- Charging station, mode 3..... 111
- Configuring week profile..... 109
- Ending the charging process..... 115
- Fast charging station, mode 3/4..... 112
- Indicator lamps on vehicle socket..... 110
- Mains socket, mode 2..... 111
- Notes on charging the high-voltage battery..... 107
- Notes on the high-voltage battery..... 180
- Starting the charging process..... 112
- Wallbox, mode 3..... 111
- Charging settings**..... 109
- Child safety lock**
- Sliding door..... 37
- Child seat**
- Adjusting the vehicle seat..... 36
- Basic instructions..... 34
- Front passenger seat..... 36
- Risks/dangers..... 34
- Securing to the front passenger seat with the seat belt..... 37
- The most important information in brief..... 34
- Children**
- Avoiding dangers in the vehicle..... 34
- Basic instructions..... 34
- Special seat belt retractor..... 36
- Cigarette lighter**..... 68
- Clean varnish**..... 173
- Cleaning**
- Paint..... 173
- Vehicle interior..... 174
- Washing by hand..... 172
- Climate control**
- A/C function..... 88
- Activating/deactivating..... 88
- Air distribution settings..... 89
- Air vents (front)..... 90
- Air-recirculation mode..... 89
- Automatically regulating..... 89
- Cargo compartment ventilation (roof ventilator)..... 91
- Clearing fogged up windows..... 89
- Control panel for 3-zone automatic climate control..... 87

- Control panel for dual-zone automatic climate control..... 86
  - Energy-saving use..... 87
  - Notes..... 87
  - Pre-entry climate control..... 91
  - Refrigerant..... 245
  - Setting the air distribution..... 89
  - Switching the rear window heater on/off..... 90
  - Switching the windshield heater on/off..... 90
  - Ventilating the vehicle (convenience opening)..... 53
  - Co-driver bench seat**
    - Folding the seat surface forwards/backwards..... 63
  - Cockpit**
    - Instrument panel..... 6
  - Coffee cup symbol**..... 131
  - Combination switch**
    - Lights..... 72
    - Rear window wiper..... 80
    - Windshield wipers..... 80
  - Components relevant to radio regulation**
    - Declaration of conformity..... 18
  - Convenience closing**
    - With the SmartKey..... 53
  - Convenience opening**
    - With the SmartKey..... 53
  - Conversions**..... 14
  - Coolant**
    - Capacity..... 245
    - Checking level..... 170
  - Copyright**
    - License..... 24
  - Copyrights**
    - Trademarks..... 25
  - Cornering light**..... 73
  - Correct use**..... 19
  - Crosswind Assist**..... 122
  - Cruise control**
    - Activating/deactivating..... 125
    - Calling up a speed..... 125
    - Function..... 125
    - Requirements..... 125
    - Setting a speed..... 125
    - Storing a speed..... 125
  - Cup holders**
    - Center console..... 68
  - Customer Assistance Center (CAC)**..... 20
- D**
- DAB announcements (audio system)**
    - Setting..... 158
  - Damage**
    - Limited protection..... 32
  - Data processing in the vehicle**..... 21
  - Data protection rights**..... 24
  - Data storage**
    - Data protection rights..... 24
    - Electronic control units..... 21
    - Event Data Recorder..... 24
    - Onboard Logic Unit..... 23
    - Online services..... 23
  - Dealership**..... 19
  - Declaration of conformity**
    - Components relevant to radio regulation..... 18
  - Definitions (tires and loading)**..... 200
  - Departure time**
    - Pre-entry climate control..... 91
  - Deployed components**
    - Limited protection..... 32
  - Deployment situations**..... 29
  - Diagnostics connection**..... 18
  - Digital inside rear view mirror**..... 83
  - Digital speedometer**..... 148
  - DIRECT SELECT lever**
    - Engaging neutral..... 106
    - Engaging park position automatically... 106
    - Engaging reverse gear..... 106
    - Function..... 105
    - Select transmission position..... 107
    - Selecting park position..... 106
    - Transmission position display..... 105
    - Transmission positions..... 105
  - Disconnect device (high-voltage on-board electrical system)**..... 94
  - Display**
    - Clean..... 174
  - Display (on-board computer)**..... 146
  - Display message, Message (instrument cluster)**
    - Calling up in the on-board computer... 251
    - Notes..... 251
  - Display messages**
    -  --- mph..... 255

-  ..... 274
-  12 V Battery See Operator's Manual..... 270
-  Acoustic Ambient Protection Inoperative..... 263
-  ATTENTION ASSIST Inoperative..... 255
-  ATTENTION ASSIST: Take a Break!..... 255
-  Automatic Driving Lights Inoperative..... 274
-  Battery Overheated Stop! Everyone Get Out! Outdoors if Possible..... 264
-  Camera View Restricted See Operator's Manual..... 256
-  Charging Cable Connected..... 261
-  Check Brake Fluid Level..... 265
-  Cooling System Fault Reduced Drive Power Service Required..... 263
-  Cooling System Fault Stop Immediately Switch Off Vehicle..... 262
-  Currently Unavailable Charge High-Voltage Battery..... 260
-  Currently Unavailable Charging of High-Voltage Battery Incomplete..... 260
-  Currently Unavailable See Operator's Manual..... 253
-  Currently Unavailable See Operator's Manual..... 254
-  Fault See Operator's Manual..... 274
-  Fault Service Required..... 264
-  Fault Service Required..... 264
-  Fault..... 264
-  Fault..... 263
-  Front Left Fault Service Required (example)..... 252
-  Have High-Voltage System Checked See Operator's Manual..... 263
-  Incline Too Steep See Operator's Manual..... 267
-  Inoperative See Operator's Manual..... 253
-  Inoperative See Operator's Manual..... 254
-  EBD Inoperative See Operator's Manual..... 254
-  Key Not Detected (red display message)..... 270
-  Key Not Detected (white display message)..... 270
-  Key Not Detected Place Key Back into Driver's Area (white display message)..... 271
-  Key Not Detected Place Key Back into Driver's Area (red display message)..... 271
-  Left Window Airbag Fault Service Required (example)..... 252
-  Low Beam Left (example)..... 274
-  HOLD Off..... 255
-  Parking Brake See Operator's Manual..... 266
-  Power Severely Limited..... 264
-  Refill Coolant See Operator's Manual..... 262
-  Refill Washer Fluid..... 272
-  Replace Key Battery..... 270
-  Replace Key..... 271
-  Reserve Level High-Voltage Battery..... 261
-  Restraint System Fault Service Required..... 252
-  Steering Fault Increased Physical Effort See Operator's Manual..... 272
-  Steering Fault Stop Immediately See Operator's Manual..... 272
-  Stop Switch Off Vehicle..... 264
-  Stop Vehicle See Operator's Manual..... 269
-  Stop Vehicle To Charge the 12 V Battery Do Not Switch Off Vehicle..... 270

|  |     |  |     |
|--|-----|--|-----|
|  Temporarily Unavailable Sensors Dirty.....               | 256 | Blind Spot Assist Trailer Not Monitored.....   | 258 |
|  To Release the Parking Brake: Switch On the Vehicle..... | 266 | Cannot Start Vehicle See Operator's Manual.....  | 261 |
|  Towing Not Permitted See Operator's Manual.....          | 263 | Charging Fault Change Charging Mode See Operator's Manual.....   | 262 |
| 120 km/h Maximum Speed Exceeded.....   | 254 | Charging Mode Currently Unavailable Try Again or Change Charging Mode.....   | 262 |
| AC Charging Inoperative Service Required.....  | 261 | Check Brake Pads See Operator's Manual.....  | 265 |
| Active Brake Assist Range of Functions Currently Reduced See Operator's Manual.....  | 258 | Check Tires.....   | 268 |
| Active Brake Assist Reduced Range of Functions See Operator's Manual....   | 259 | Cruise Control Inoperative.....  | 255 |
| Active Distance Assist Available Again.....  | 257 | DC Charging Inoperative Service Required.....  | 261 |
| Active Distance Assist Currently Unavailable See Operator's Manual....   | 257 | Do Not Change Drive Range Service Required.....  | 273 |
| Active Distance Assist Inoperative.....  | 257 | Do Not Restart Vehicle Service Required.....   | 261 |
| Active Lane Keeping Assist Currently Unavailable See Operator's Manual.....  | 258 | Heating/Air Conditioning Energy Saving Mode Active.....  | 260 |
| Active Lane Keeping Assist Inoperative.....  | 258 | High-voltage Battery Fault No Start in Approx. XXX mi Service Required (red display message).....                    | 265 |
| Active Lane Keeping Assist Reduced Range of Functions See Operator's Manual.....   | 258 | High-Voltage Battery Fault No Start in Approx. XXX mi Service Required (yellow display message).....                 | 265 |
| Adaptive Highbeam Assist Currently Unavailable See Operator's Manual....   | 274 | High-Voltage Battery Fault Service Required Do Not Restart the Vehicle...  | 265 |
| Adaptive Highbeam Assist Inoperative.....  | 274 | N Permanently Active: Risk of Rolling..  | 273 |
| Apply Brake to Shift from Drive Range P.....   | 272 | Not Possible to Unlock Charging Cable See Operator's Manual.....   | 262 |
| Authentication Failed Use Different Authentication Method or Charging Station.....   | 261 | Observe Range.....   | 265 |
| Blind Spot Assist and Exit Warning Inoperative.....  | 258 | Observe Range Service Required.....  | 265 |
| Blind Spot Assist and Exiting Warning Currently Unavailable See Operator's Manual.....   | 257 | Only Shift to Drive Range P when Vehicle is Stationary.....  | 273 |
|  |     | Place Key in the Marked Space See Operator's Manual.....   | 270 |
|  |     | Please Charge High-Voltage Battery if Vehicle will be Parked for an Extended Period at Low Outside Temperatures..... | 261 |
|  |     | Please Correct Tire Pressure.....  | 268 |

- Pre-entry Climate Control via Key Available Again After Vehicle Start..... 259
- Pre-entry Climate Control via Key Inoperative High-Voltage Battery Low.. 259
- Reduced Drive Power See Operator's Manual..... 263
- Reversing Not Possible: Service Required..... 273
- Risk of Rolling Driver's Door Open Drive Range P Not Selected..... 273
- Risk of Rolling Driver's Seat Not Occupied Drive Range P Not Selected..... 272
- Shift to Drive Range P or N to Start Engine..... 272
- SOS NOT READY..... 273
- Speed Limit (Winter Tires) XXX mph.... 255
- Tire Press. Monitoring System Currently Unavailable..... 269
- Tire Pressure Monitoring System Inoperative..... 269
- Tire Pressure Monitoring System Inoperative Tire Pressure Sensors Missing..... 269
- Tire Pressure Sensors Missing..... 269
- To Deselect Drive Range P or N Depress Brake and Start Vehicle..... 272
- To Engage Drive Range R First Depress the Brake..... 272
- Transmission Fault Stop..... 273
- Vehicle Currently Not Being Charged Charging Station Fault..... 261
- Wait in READY State Battery Is Warming Up See Operator's Manual.... 260
- Warning Tire Fault..... 268
- Displaying range (trip menu)..... 148**
- Displaying total distance (trip menu), Odometer..... 148**
- Distance control..... 126**
- Distance warning..... 123**
- DISTRONIC..... 126**
- Door**
  - Activating/deactivating the automatic locking mechanism..... 43
  - Locking/unlocking mechanical key..... 44
  - Opening (from the inside)..... 41
  - Unlocking (from the inside)..... 41
- Door control panel..... 10**
- DOT, Tire Identification Number (TIN)..... 198**
- Double co-driver's seat..... 63**
- Drinking and driving..... 98**
- Drive program display..... 105**
- Drive system, Engine**
  - Manually disconnecting..... 94
  - Starting (in emergency operation mode)..... 98
  - Starting (start/stop button)..... 97
  - Switching off (start/stop button)..... 116
- Driving in winter..... 101**
- Driving instructions**
  - Acoustic presence indicator (sound generator)..... 94
  - Brakes..... 100
  - Breaking-in notes..... 98
  - Downhill gradient..... 100
  - Drinking and driving..... 98
  - Driving abroad (information)..... 100
  - Driving in winter..... 101
  - Electric mode..... 94
  - General driving tips..... 98
  - Light adjustment when driving abroad... 71
  - Limit speed..... 99
  - Limited braking effect (salt-treated roads)..... 100
  - New brake disks/brake linings..... 100
  - Parking brake..... 100
  - Recuperation..... 95
  - Slippery road surfaces..... 101
  - Subjecting brakes to a load..... 100
  - Wet road surfaces (brake)..... 100
- Driving notes**
  - Transport by rail..... 100
- Driving safety system**
  - ABS (anti-lock braking system)..... 120
  - Active Brake Assist..... 123
  - ASR (acceleration skid control)..... 121
  - ATTENTION ASSIST..... 131
  - BAS (Brake Assist System)..... 121
  - Blind Spot Assist..... 132
  - Cameras..... 119
  - Cruise control..... 125
  - EBD (Electronic Brakeforce Distribution)..... 122
  - ESP® (Electronic Stability Program).... 121
  - ESP® Crosswind Assist..... 122
  - ESP® trailer stabilization..... 122

- Hill Start Assist..... 129
  - HOLD function..... 129
  - Overview..... 120
  - Radar and ultrasonic sensors..... 119
  - Your responsibility..... 119
  - Driving system**..... 120
  - Driving tips**
    - Driving off-road..... 101
    - Driving on flooded roads..... 101
    - Driving on wet roads..... 101
    - Hydroplaning..... 101
  - Drowsiness detection**..... 131
  - Drunk driving**..... 98
  - Dual-zone automatic climate control (control panel)**..... 86
  - Dynamic handling control system**..... 121
- E**
- EBD, Electronic Brakeforce Distribution**..... 122
  - ECO display**
    - Function..... 103
    - Resetting..... 149
  - Electric closing aid (sliding door)**..... 46
  - Electric mode**
    - Notes..... 94
  - Electric parking brake**
    - Automatically applying..... 117
    - Emergency braking..... 118
    - Manually applying/releasing..... 118
    - Notes..... 117
    - Releasing automatically..... 118
  - Electric sliding door**
    - Function..... 46
    - Open/close with button..... 46
    - open/close with key button..... 47
    - Opening with the door handle..... 48
    - Opening/closing (from the inside)..... 46
    - Resetting..... 49
    - Unlocking manually..... 48
  - Electrical fuses**
    - Notes..... 184
  - Electronic Stability Program**
    - Activating/deactivating..... 122
  - Electronics**
    - Engine electronics..... 212
    - Installing two-way radios..... 212
  - Emergency**
    - First-aid kit (soft-sided)..... 177
    - Overview of assistance..... 12
    - Safety vest..... 177
  - Warning lamp..... 177
  - Emergency braking**
    - Electric parking brake..... 118
  - Emergency call system**
    - Automatic emergency call..... 178
    - Information..... 177
    - Manual emergency call..... 178
    - Overview..... 178
    - Transferred data..... 179
  - Emergency exit**
    - Emergency hammer..... 177
  - Emergency hammer**..... 177
  - Emergency key**
    - Removing/inserting..... 40
  - Emergency operation mode**
    - Starting the vehicle..... 98
  - Emergency shutoff (high-voltage on-board electrical system)**..... 94
  - Emergency start (drive system)**..... 184
  - Emergency Tensioning Devices**
    - Inflating..... 29
  - Emergency unlocking (vehicle socket)**..... 115
  - Energy consumption**
    - SmartKey..... 40
  - Energy consumption (on-board computer)**..... 148
  - Engaging reverse gear**..... 106
  - Engine electronics**..... 212
  - Engine number**..... 241
  - Environmental protection**
    - Driving style..... 13
  - Environmentally friendly driving style**..... 13
  - ESC, Electronic Stability Control**..... 121
  - ESP®**
    - Activating/deactivating..... 122
    - Crosswind Assist..... 122
    - Function..... 121
    - Trailer stabilization..... 122
  - Event Data Recorder**..... 24
  - Exit warning**
    - Blind Spot Assist..... 132
  - Exterior lighting**
    - Care..... 173
    - Replacing illuminants (front)..... 76
- F**
- Factory settings (audio system)**..... 157

|  |     |  |          |
|--|-----|--|----------|
| <b>Fastening</b> .....                         | 28  | <b>Heating system</b> .....  | 85       |
| <b>First aid</b>                               |     | <b>High beam</b>   |          |
| First-aid kit (soft-sided).....                | 177 | Activating/deactivating.....   | 72       |
| <b>First-aid kit (soft-sided)</b> .....        | 177 | Adaptive Highbeam Assist.....  | 74       |
| <b>Flat tire</b>                               |     | Changing bulbs.....  | 77       |
| Changing a wheel.....                          | 204 | <b>High-voltage battery, Battery (high-voltage on-board electrical system)</b> |          |
| Tire-change tool kit.....                      | 203 | Calibrating (on-board computer menu).....                                      | 150      |
| <b>Floor mats</b> .....                        | 70  | Calibration.....   | 167      |
| <b>Foil covering</b>                           |     | Charge level display.....  | 108      |
| Radar and ultrasonic sensors.....              | 119 | Charging at time of departure.....   | 109      |
| <b>Free software</b> .....                     | 24  | Charging cable plug emergency release.....                                     | 115      |
| <b>Frequencies</b>                             |     | Charging duration.....   | 246      |
| Mobile phone.....                              | 213 | Charging station, mode 3.....  | 111      |
| Two-way radios.....                            | 213 | Configuring week profile.....  | 109      |
| <b>Front air bag</b>                           |     | Disconnect device.....   | 94       |
| Inflating.....                                 | 29  | Ending the charging process.....   | 115      |
| <b>Front seat</b>                              |     | Energy content.....  | 246      |
| 8-way adjustment options.....                  | 60  | Fast charging station, mode 3/4.....   | 112      |
| Adjusting (electrically).....                  | 60  | General notes on charging.....   | 107      |
| Adjusting manually.....                        | 59  | Mains socket, mode 2.....  | 111      |
| Manually adjusting.....                        | 57  | Manually calibrating.....  | 168      |
| Memory function.....                           | 60  | Notes.....   | 180      |
| Rotating.....                                  | 62  | Notes on calibrating.....  | 166, 168 |
| <b>Function the event of an accident</b> ..... | 30  | Starting the charging process.....   | 112      |
| <b>Fuses</b>                                   |     | Type.....  | 246      |
| Fuse box (co-driver footwell).....             | 185 | Wallbox, mode 3.....   | 111      |
| Fuse box (seat base of driver's seat)....      | 185 | <b>High-voltage on-board electrical system</b>                                 |          |
| Notes.....                                     | 184 | Indicator lamps on vehicle socket.....   | 110      |
| <b>G</b>                                       |     | <b>Hill Start Assist</b> .....   | 129      |
| <b>Genuine parts</b> .....                     | 13  | <b>HOLD function</b>   |          |
| <b>Genuine wood (Care)</b> .....               | 174 | Notes.....   | 129      |
| <b>Getting in/getting out</b> .....            | 44  | Switching on/off.....  | 130      |
| <b>Grab handles</b>                            |     | <b>Hydroplaning</b> .....  | 101      |
| Using.....                                     | 44  | <b>I</b>   |          |
| <b>Gross axle weight rating</b> .....          | 241 | <b>Identification plate</b> .....  | 241      |
| <b>Gross vehicle weight</b> .....              | 241 | <b>Immobilizer</b> .....   | 54       |
| <b>Gross vehicle weight rating</b> .....       | 241 | <b>Inattention detection</b> .....   | 131      |
| <b>H</b>                                       |     | <b>Incorrect behavior by vehicle occupants</b>                                 |          |
| <b>Handling characteristics</b>                |     | Limited protection.....  | 31       |
| Unusual.....                                   | 188 | <b>Indicator</b>   |          |
| <b>hands-free system</b> .....                 | 159 | Changing bulbs (front).....  | 77       |
| <b>Hazard warning light system</b> .....       | 73  | <b>Indicator lamps</b>   |          |
| <b>Head restraint</b>                          |     | Overview.....  | 7        |
| Adjusting manually.....                        | 65  | <b>Inside rear view mirror</b>   |          |
| <b>Headlamp flashing</b> .....                 | 72  | Digital inside rear view mirror.....   | 83       |
| <b>Headliner (care)</b> .....                  | 174 | <b>Inside rear view mirror display</b>   |          |
|  |     | Rear view camera.....  | 130      |

- Inside rearview mirror**  
Adjusting/setting anti-glare mode..... 84
- Installation of accessories**  
Limited protection..... 31
- Installations**..... 14
- Instrument cluster, Instrument display**  
Adjusting the lighting..... 150  
Available power display..... 146  
Charge level display..... 146  
Function/notes..... 144  
Menu overview..... 147  
Notes..... 144  
Overview..... 7, 144  
Power display..... 145
- Instrument cluster display (on-board computer)**..... 146
- Instrument lighting, Dashboard lighting**..... 150
- Instrument panel**  
Cockpit..... 6
- Intelligent light system**  
Adaptive Highbeam Assist..... 74  
Cornering light..... 73
- Intellitext™ (audio system)**  
Setting..... 158
- Interior lamp**  
Replacing illuminants (rear passenger compartment)..... 79
- Interior lighting**  
Box bodies..... 75  
Cargo compartment..... 75  
Motion detector (rear passenger compartment)..... 75  
Rear compartment..... 75  
Setting..... 74
- Interior motion sensor**  
Activating/deactivating..... 56  
Function..... 56
- iPod® (audio system)**  
Starting playback..... 159
- J**
- Jack**  
Hydraulic..... 186  
Removing from stowage compartment (hydraulic jack)..... 187  
Storage location..... 203  
Storage location (hydraulic jack)..... 186
- Journeys abroad**  
Light adjustment low beam..... 71  
Notes..... 100
- Jump-start connection, Starting assistance**..... 181
- K**
- Key**  
Battery..... 40  
Central locking system..... 40  
electric sliding door open/close..... 47  
Emergency key..... 40  
Fastening to keyring..... 40  
Functions..... 39  
Pre-entry climate control..... 91  
Problem..... 41  
Radio connection..... 39  
Unlocking setting..... 40
- L**
- Lamp**..... 76
- Lane recognition**..... 136
- License plate (front)**..... 17
- License plate assembly (front)**..... 17
- License plate lamp**  
Replacing light bulbs..... 79
- Light switch (overview)**..... 71
- Lights, Lighting**  
Adaptive Highbeam Assist..... 74  
Adjusting the instrument lighting..... 150  
Automatic driving lights..... 71  
Combination switch..... 72  
Cornering light..... 73  
Hazard warning lights..... 73  
Headlamp flashing..... 72  
Headlamp range..... 72  
High beam..... 72  
Light adjustment when driving abroad... 71  
Light switch..... 71  
Low beam..... 71  
Parking lamps..... 71  
Rear fog light..... 71  
Responsibility with lighting systems..... 71  
Turn signal light..... 72
- Limit speed**  
Notes..... 99
- Limited Warranty**..... 21
- Load**  
Determining the maximum..... 195  
Sample calculation..... 196
- Load distribution**..... 162
- Load securing**  
Cargo tie-down points..... 164  
Notes..... 163

- Load-bearing capacity (tires)**..... 199
- Loading**
- Definitions..... 200
- Loading guidelines**..... 162
- Loading information table**..... 195
- Locking/unlocking**
- Activating/deactivating the automatic locking mechanism..... 43
  - Doors (interior)..... 41
  - Mechanical key..... 44
- Low beam**
- Activating/deactivating..... 71
  - Changing bulbs..... 77
  - Light adjustment when driving abroad... 71
- Lubricants**
- Notes on operating fluids..... 243
- Lumbar support (4-way)**..... 62
- M**
- M+S tires**..... 189
- Maintaining safe distance**
- Active Distance Assist DISTRONIC..... 128
- Maintenance**
- Paint..... 173
  - Vehicle..... 15
- Malfunction**
- Restraint system..... 28
- Malfunction message**
- Notes on display messages..... 251
- Maximum load**
- Determining..... 195
  - Sample calculation..... 196
- Maximum tire load**..... 198
- Maximum tire pressure**..... 199
- MBUX multimedia system**
- MB Apps..... 154
- Mechanical key**
- Locking/unlocking the door..... 44
- Medical aids**..... 20
- Memory function**
- Outside mirrors..... 62
  - Seat..... 62
- Menu (on-board computer)**
- Assistance graphic..... 147
  - Battery calibration..... 150
  - Overview..... 145, 147
  - Service..... 147
  - Settings..... 149
  - Trip..... 148
- Mercedes-Benz Connect**
- Accident and Breakdown Management Digital Extras..... 153
  - Information..... 153
  - Making a call via the overhead control panel..... 151
  - Transferred data..... 154
- Mercedes-Benz Connect calls**
- Arranging a service appointment..... 151
  - Information on the call via the overhead control panel..... 151
  - Making a call via the overhead control panel..... 151
  - Transferred data..... 152
- Mercedes-Benz emergency call system**
- Self-diagnosis..... 179
- Mercedes-Benz GenuineParts**..... 13
- Message memory**..... 251
- Mirror**
- Adjusting/setting anti-glare mode (inside rearview mirror)..... 84
  - Adjusting/setting anti-glare mode (outside mirrors)..... 82
- Mirrors**
- Digital inside rear view mirror..... 83
- Mobile phone**
- Frequencies..... 213
  - Maximum transmission output..... 213
- Modification**
- Limited protection..... 32
- Motion detector (cargo compartment)**..... 75
- Mounting a load**..... 162
- Moving-off Information Assist**
- Activating/deactivating..... 135
  - Function..... 135
  - System limits..... 135
  - Warning by Moving-off Information Assist..... 136
- Multi Purpose Vehicle (MPV)**..... 19
- N**
- Nominal tensile load of cargo tie-down rings**..... 249
- O**
- Objects in the vehicle interior**
- Limited protection..... 31
- Occupant safety**
- Air bag..... 33
  - Automatic measures after an accident.. 29

- Basic information..... 26
  - Child seat..... 34
  - Information on the child restraint system..... 29
  - Information on the correct seat position..... 26
  - Pets in the vehicle..... 31
  - On-board computer, Computer**
    - Assistant display menu..... 147
    - Battery calibration menu..... 150
    - Displaying the service due date..... 166
    - Instrument cluster display..... 146
    - Menu overview..... 145, 147
    - Operating..... 145
    - Service menu..... 147
    - Settings menu..... 149
    - Trip menu..... 148
  - On-board diagnostic interface**..... 18
  - On-board electronics**
    - Engine electronics..... 212
    - Installing two-way radios..... 212
  - Onboard Logic Unit**
    - Data storage..... 23
    - Online services..... 23
  - Online services**..... 23
  - Open-source software**..... 24
  - Opening/closing the hood**..... 169
  - Operating fluids**
    - Brake fluid..... 244
    - Notes..... 243
    - Notes on coolant (drive system)..... 244
    - Refrigerant (air conditioning system)... 245
    - Windshield cleaning agent..... 245
  - Operating safety**
    - Audio system..... 155
  - Operating system**
    - On-board computer..... 145
  - Outside mirrors**
    - Adjusting/setting anti-glare mode..... 82
    - Blind Spot Assist..... 132
    - Folding in/out..... 82
    - Memory function..... 62
    - Setting options..... 10
  - Overhead control panel**
    - Adjusting the interior lighting..... 74
    - Overview..... 8
- P**
- Paint code**..... 241
  - Park position**
    - Engaging..... 106
    - Selecting automatically..... 106
  - Parking for an extended period**..... 118
  - Parking lamps**..... 71
  - Partition sliding door**
    - Opening/closing..... 51
  - Permitted towing methods**
    - Overview..... 181
  - Pets in the vehicle**..... 31
  - Phone book (audio system)**
    - Downloading mobile phone contacts... 161
    - Searching for contacts..... 161
  - Placing a load on the wheel arch**..... 165
  - Plastic trim (Care)**..... 174
  - Post-collision brake**..... 29
  - Power display**
    - Function/notes..... 145
  - Power supply**
    - Switching on (start/stop button)..... 96
  - Power washer (care)**..... 172
  - Pre-entry climate control**
    - Activating..... 92
    - Notes..... 91
    - Switching on/off via the button..... 92
    - Via the key..... 91
  - Program selector button, Drive programs**
    - Drive program display..... 105
    - Drive programs..... 104
    - Function..... 104
    - Selecting the drive program..... 105
  - Protection**
    - Limited..... 31
  - Pulling away**..... 129
- Q**
- QR code rescue card**..... 21
  - Qualified specialist workshop**..... 19
- R**
- Radar and ultrasonic sensors**
    - Damage..... 119
  - Radar sensors**
    - Care..... 173
  - Radio (audio system)**
    - DAB announcements..... 158
    - Intellitext™..... 158
    - Program preview (EPG)..... 158
    - Saving radio stations..... 157

- Selecting the frequency band..... 157
  - Setting stations..... 157
  - Switching traffic announcements on/off..... 158
  - Radio connection**
    - Key..... 39
  - Radio regulations**
    - Regulatory radio identification..... 213
  - Rear compartment lighting (motion detector)**..... 75
  - Rear fog light**..... 71
  - Rear view camera**
    - Inside rear view mirror display..... 130
  - Rear window wiper**
    - Switching on/off..... 80
  - Rear-end doors**
    - open over 90°..... 50
    - Opening/closing (from the inside)..... 51
    - Opening/closing (from the outside)..... 49
  - Rear-view camera**
    - Display/hide the inside rear-view mirror display..... 131
  - Recuperation**
    - Function..... 95
    - Setting..... 96
  - Refrigerant (air conditioning system)**..... 245
  - Registration**..... 19
  - Regulating headlamp range**..... 72
  - Regulatory radio information**
    - Specific absorption rate..... 240
  - Replacement key, Spare key**..... 41
  - Replacing**
    - Fuses..... 184
  - Replacing light bulbs**
    - Interior lamp (rear passenger compartment)..... 79
    - License plate lamp..... 79
    - Light sources (front)..... 76
    - Notes..... 76
  - Replacing light sources**
    - Backing up lamp..... 78
    - Tail lamp types..... 77
    - Turn signal lights (rear)..... 78
  - Reporting safety defects**..... 21
  - Rescue card, QR code**..... 21
  - Rescue separation point (high-voltage on-board electrical system)**..... 94
  - Responsibility**
    - Driving safety systems..... 119
  - Restraint system**
    - Basic information..... 26
    - Basic instructions for children..... 34
    - Deployment situations..... 29
    - Functionality..... 28
    - Information on function..... 30
    - Information on the correct seat position..... 26
    - Limited protection..... 32
    - Malfunction..... 28
    - Protection..... 26
    - Self-test..... 28
    - Warning lamp..... 28
  - Reversing camera**
    - Care..... 173
  - Roadside Assistance (breakdown)**..... 15
  - Roll-away prevention**..... 129
  - Roof load**..... 249
  - Roof luggage rack, Carrier system**
    - Loads..... 249
    - Securing..... 164
  - Roof ventilator**
    - Activating/deactivating cargo compartment ventilation..... 91
- S**
- Safety system**..... 120
  - Safety vest**..... 177
  - Seat, Driver's seat**
    - 4-way lumbar support..... 62
    - 8-way adjustment options..... 60
    - Adjusting electrically (front)..... 60
    - Adjusting manually (front)..... 57, 59
    - Adjusting the head restraint manually.... 65
    - Adjusting the seat surface (co-driver bench seat)..... 63
    - Correct driver's seat position..... 57
    - Door control panel..... 10
    - Folding the folding seat up/down..... 64
    - Memory function..... 60, 62
    - Notes for vehicles without a front passenger seat..... 64
    - Rotating (front seat)..... 62
    - Side impact air bag..... 33
    - Switching seat heating on/off..... 66
  - Seat belt**
    - Adjusting the height..... 28
    - Clean..... 174
    - Fastening..... 28
    - Notes on wearing correctly..... 27
    - Unfastening..... 33
    - Warning lamp..... 28













- Seat belt warning..... 28
- Seat cover (Care)..... 174
- Securing loads
  - Cargo tie-down rings..... 164
- Securing luggage..... 162
- Select transmission position, Drive position..... 107
- Selector lever..... 105
- Self-test
  - Restraint system..... 28
- Sensors
  - Information..... 119
- Sensors (care)..... 173
- Service (on-board computer)..... 147
- Service center..... 19
- Setting a limit speed for winter tires..... 126
- Setting the air distribution..... 89
- Settings (on-board computer)..... 149
- Shifting to neutral (transmission)..... 106
- Side windows
  - Closing with the SmartKey..... 53
  - Convenience closing..... 53
  - Convenience opening..... 53
  - Opening with the SmartKey..... 53
  - Opening/closing..... 52
  - Problem..... 54
  - Resetting..... 54
- Sideguard Assist
  - Activating/deactivating the warning tone..... 134
  - Function and notes..... 133
  - System limits..... 134
  - Warning by Sideguard Assist..... 134
- Size designation (tires)..... 199
- Sliding door
  - Child safety lock..... 37
  - electric sliding door..... 46
  - electrical closing aid..... 46
  - Function..... 46
  - Open/close with button..... 46
  - Opening/closing (from the inside)..... 45
  - opening/closing (from the outside)..... 45
- Slippery road surfaces..... 101
- SmartKey
  - Deactivating the function..... 40
  - Energy consumption..... 40
- Snow chains..... 189
- Socket
  - Trailer hitch..... 140
- Socket (12 V)
  - Center console (front)..... 69
- Socket (115 V)
  - Front center console..... 69
  - Notes..... 69
- Socket flap..... 112
- SOS button..... 151
- Sound generator..... 94
- Spare parts..... 13
- Spare wheel
  - Installing/removing..... 209
  - Notes..... 208
- Special seat belt retractor..... 36
- Specialist workshop..... 19
- Specific absorption rate (SAR)..... 240
- Speed
  - Save, cruise control..... 128
  - Save, DISTRONIC..... 128
- Speed control
  - Active Distance Assist DISTRONIC..... 126
  - Cruise control..... 125
- Speed rating (tires)..... 199
- Speedometer (digital)..... 148
- Start-off assist..... 129
- Start/stop button
  - Parking the vehicle..... 116
  - Starting the vehicle..... 97
  - Switching on the power supply or the vehicle..... 96
- Starting-off aid..... 129
- Steering wheel
  - Adjusting..... 66
  - Driver's air bag..... 33
  - Steering wheel heater..... 67
- Steering wheel heater..... 67
- Stopping the alarm..... 55
- Stowage areas..... 67
- Stowage compartment (vehicle tool kit)..... 186
- Stowage space
  - Armrest..... 67
  - Bottle holder..... 68
  - Center console..... 67
  - Door..... 67
  - Glove box..... 67
- Substances hazardous to health..... 16





- Summer tires**..... 188  
**Switching on the vehicle (start/stop button)**..... 96  
**Switching seat heating on/off**..... 66  
**Switching the rear window heater on/off**.... 90  
**Switching the windshield heater on/off**.... 90
- T**
- Technical data**  
 Coolant filling capacity..... 245  
 Information..... 212  
 Notes on trailer hitch..... 247  
 Radio regulations..... 213  
 Specific absorption rate (SAR)..... 240  
 Tire pressure monitoring system..... 194  
 Vehicle dimensions..... 246  
 Vehicle identification plate..... 241
- Telephone**  
 Activating functions during a call..... 161  
 Connecting a mobile phone..... 160  
 Incoming call during an existing call.... 161  
 Notes..... 159  
 Secure Simple Pairing..... 160  
 Setting the ringtone..... 160  
 Telephone operation..... 160
- Telephone (audio system)**  
 Disconnecting a mobile phone..... 160  
 Replacing a mobile phone..... 160  
 Setting the ringtone..... 160
- Tire and Loading Information placard**..... 195  
**Tire Identification Number (TIN)**..... 198  
**Tire information table**..... 195  
**Tire labeling, Labeling (tires)**  
 Characteristics..... 199  
 DOT, Tire Identification Number (TIN).. 198  
 Load-bearing capacity..... 199  
 Maximum tire load..... 198  
 Maximum tire pressure..... 199  
 Overview..... 197  
 Size designation..... 199  
 Speed rating..... 199  
 Temperature grade..... 197  
 Tire quality grades..... 197  
 Tread wear grade..... 197
- Tire load (maximum)**..... 198  
**Tire pressure**  
 Checking manually..... 193  
 Maximum..... 199  
 Notes..... 190  
 Restarting the tire pressure monitor.... 194  
 Tire pressure monitoring system  
 ..... 192, 193  
 Tire pressure table..... 191
- Tire pressure monitoring system**  
 Checking the air pressure..... 193  
 Checking the temperature..... 193  
 Function..... 192  
 Technical data..... 194
- Tire pressure table**..... 191  
**Tire temperature**  
 Checking..... 193  
 Tire pressure monitoring system..... 192
- Tire tread**..... 188  
**Tire-change tool kit**..... 203
- Tires**  
 Characteristics..... 199  
 Checking..... 188  
 Checking the temperature..... 193  
 Definitions..... 200  
 Direction of rotation..... 203  
 DOT, Tire Identification Number (TIN).. 198  
 Installing..... 206  
 Load-bearing capacity..... 199  
 M+S tires..... 189  
 Maximum tire load..... 198  
 Maximum tire pressure..... 199  
 Mounting..... 202  
 Noise..... 188  
 Overview of tire labeling..... 197  
 Removing..... 206  
 Replacing..... 202, 204  
 Restarting the tire pressure monitor.... 194  
 Selection..... 202  
 Size designation..... 199  
 Snow chains..... 189  
 Speed rating..... 199  
 Storing..... 203  
 Summer tires..... 188  
 Tire and Loading Information placard.. 195  
 Tire pressure monitoring system..... 192  
 Tire pressure table..... 191  
 Tire quality grades..... 197  
 Unusual handling characteristics..... 188
- Touch Control**  
 On-board computer..... 145
- Tow-away alarm**  
 Activating/deactivating..... 55  
 Function..... 55
- Tow-starting**..... 184
- Towing**  
 Raised rear axle..... 183  
 Towing methods..... 181

- Towing eye**
    - Installing/removing..... 184
    - Storage location..... 183
  - Towing methods**
    - Both axles on the ground..... 182
    - Overview..... 181
  - Track information**
    - Displaying..... 159
  - Traffic announcements (audio system)**
    - Switching on/off..... 158
  - Trailer hitch**
    - Care..... 173
    - Coupling/uncoupling a trailer..... 140
    - Information..... 141
    - Information about trailer operation..... 138
    - Notes..... 247
    - Permissible trailer loads and trailer drawbar noseweights..... 142
    - Power supply..... 143
    - Socket..... 140
  - Trailer loads**..... 247
  - Trailer operation**
    - Active Lane Keeping Assist..... 136
    - Coupling/uncoupling a trailer..... 140
    - Information..... 141
    - Notes..... 138
    - Permissible trailer loads and trailer drawbar noseweights..... 142
    - Power supply..... 143
    - Setting..... 140
    - Socket..... 140
    - Trailer loads..... 247
  - Trailer stabilization**..... 122
  - Transmission**
    - Drive program display..... 105
    - Drive programs..... 104
    - Engaging neutral..... 106
    - Engaging reverse gear..... 106
    - Program selector button..... 104
    - Selecting park position..... 106
  - Transmission position display**..... 105
  - Transport (vehicle)**..... 183
  - Transport by rail**..... 100
  - Trim element (Care)**..... 174
  - Trip**
    - Displaying total distance..... 148
    - Menu (on-board computer)..... 148
  - Trip computer**
    - Displaying..... 148
    - Resetting..... 149
  - Trip distance, Distance recorder, Trip odometer**
    - Displaying..... 148
    - Resetting..... 149
  - Turn signal light**
    - Changing bulbs (rear)..... 78
  - Two-way radios**
    - Frequencies..... 213
    - Installation..... 212
    - Maximum transmission output..... 213
- U**
- Unfastening**..... 33
  - Unlocking setting**..... 40
  - USB device (audio system)**
    - Showing track information..... 159
    - Starting playback..... 158
  - Using the chock**..... 119
- V**
- Vehicle, Starting the vehicle**
    - Activating/deactivating the automatic locking mechanism..... 43
    - Correct use..... 19
    - Data storage..... 21
    - Diagnostics connection..... 18
    - Identification plate..... 241
    - Limited Warranty..... 21
    - loading..... 183
    - lock automatically..... 43
    - Locking/unlocking (from the inside)..... 42
    - Locking/unlocking mechanical key..... 44
    - Lowering..... 207
    - Maintenance..... 15
    - Medical aids..... 20
    - Parking for an extended period..... 118
    - Problem notification..... 20
    - QR code rescue card..... 21
    - Raising..... 204
    - Registration..... 19
    - Starting (in emergency operation mode)..... 98
    - Starting (start/stop button)..... 97
    - Switching off (start/stop button)..... 116
    - Switching on the power supply (start/stop button)..... 96
    - Towing away..... 181
    - Ventilating (convenience opening)..... 53
  - Vehicle cameras**..... 119
  - Vehicle data**
    - Vehicle height..... 246
    - Vehicle length..... 246

Vehicle width..... 246  
 Wheelbase..... 246  
**Vehicle identification number**..... 241  
**Vehicle identification plate**..... 241  
**Vehicle key**..... 39  
**Vehicle operation outside the USA or Canada**..... 15  
**Vehicle sensors**..... 119  
**Vehicle socket**  
     Emergency unlocking..... 115  
     Indicator lamps..... 110  
**Vehicle tool kit, Tool**  
     Removing..... 186  
     Stowage compartment..... 186  
     Towing eye..... 183  
**Vehicle's high-voltage on-board electrical system**  
     Charging cable plug emergency release..... 115  
     Disconnect device..... 94  
     Manually disconnecting..... 94  
     Rescue separation point..... 94  
**Vehicles without a front passenger seat**  
     Notes..... 64  
**Vents**..... 90  
**VIN**..... 241

**W**

**Warning lamp**..... 177  
**Warning system**..... 54  
**Warning/indicator lamp**  
      ABS warning lamp..... 278  
      Active Brake Assist warning lamp..... 279  
      Brakes warning lamp (red)..... 277  
      Brakes warning lamp (yellow).... 277  
      Distance warning lamp..... 279  
      Door indicator lamp..... 279  
      Electrical malfunction warning lamp..... 280  
      ESP® OFF warning lamp..... 276  
      ESP® warning lamp flashes..... 276  
      ESP® warning lamp lights up.... 276  
      High-voltage battery reserve.... 280  
      High-voltage battery warning.... 280

 Parking brake indicator lamp (red)..... 277  
 Parking brake indicator lamp (yellow)..... 277  
 Power steering warning lamp (red)..... 279  
 Reduced warning lamp power... 280  
 Restraint system warning lamp..... 275  
 Seat belt warning lamp flashes..... 275  
 Seat belt warning lamp lights up..... 276  
 System malfunction warning lamp..... 280  
 Tachograph warning lamp..... 279  
 Tire pressure monitoring system warning lamp flashes..... 280  
 Tire pressure monitoring system warning lamp lights up..... 281

**Warning/indicator lamps**  
     Overview..... 7, 274  
**Warranty terms and conditions**..... 15  
**Washer fluid**..... 245  
**Washing by hand**..... 172  
**Wear**  
     Limited protection..... 32  
**Website**  
     Mercedes-Benz Connect..... 153  
**WET WIPER SYSTEM**..... 81  
**Wheel rotation**..... 203  
**Wheel wrench**..... 203  
**Wheels**  
     Care..... 173  
     Changing..... 203  
     Characteristics of the tire..... 199  
     Checking..... 188  
     Checking the air pressure..... 193  
     Checking the temperature..... 193  
     Definitions..... 200  
     DOT, Tire Identification Number (TIN).. 198  
     Flat tire..... 179  
     Installing..... 206  
     Load-bearing capacity..... 199  
     Maximum tire load..... 198  
     Maximum tire pressure..... 199

|   |            |
|---|------------|
| Mounting.....   | 202        |
| Noise.....  | 188        |
| Overview of tire labeling.....                        | 197        |
| Removing.....   | 206        |
| Replacing.....  | 202, 204   |
| Restarting the tire pressure monitor....              | 194        |
| Selection.....  | 202        |
| Size designation.....                                 | 199        |
| Snow chains.....                                      | 189        |
| Speed rating.....                                     | 199        |
| Storing.....  | 203        |
| Tire and Loading Information placard..                | 195        |
| Tire pressure.....                                    | 190        |
| Tire pressure monitoring system.....                  | 192        |
| Tire pressure table.....                              | 191        |
| Tire quality grades.....                              | 197        |
| Tread wear grade.....                                 | 197        |
| Unusual handling characteristics.....                 | 188        |
| <b>Wheels (care).....</b>                             | <b>173</b> |
| <b>Window curtain air bag.....</b>                    | <b>33</b>  |
| <b>Windows</b>  |            |
| Opening/closing.....                                  | 52         |
| <b>Windows (care).....</b>                            | <b>173</b> |
| <b>Windshield</b>                                     |            |
| Replacing the wiper blades.....                       | 80         |
| <b>Windshield cleaning agent.....</b>                 | <b>245</b> |
| <b>Windshield wiper</b>                               |            |
| Replacing wiper blades (rear window)....              | 82         |
| Switching on/off (rear window).....                   | 80         |
| <b>Windshield wipers</b>                              |            |
| Replacing the wiper blades.....                       | 80         |
| Replacing the wiper blades (WET<br>WIPER SYSTEM)..... | 81         |
| Replacing the wiper blades (wind-<br>shield).....     | 80         |
| Switching on/off.....                                 | 80         |
| Switching on/off (windshield).....                    | 80         |
| <b>Winter operation.....</b>                          | <b>189</b> |
| <b>Winter tires</b>                                   |            |
| Notes.....  | 189        |
| Setting a default limit speed.....                    | 126        |
| <b>Wiper blades</b>                                   |            |
| Care.....   | 173        |
| Replacing (rear window).....                          | 82         |
| Replacing (WET WIPER SYSTEM).....                     | 81         |
| Replacing (windshield).....                           | 80         |
| <b>Workshop.....</b>                                  | <b>19</b>  |

